

Service Manual Cars

Section 3 (39) Wiring diagram S60 2001

TP 3955202

Abbreviations	3
How to use the wiring diagram	4

Electrical distribution

Overview	6
Fuses in the engine compartment	8
Fuses in the passenger compartment	11
Fuses in cargo compartment	15
Ignition switch with relays	17
Relays in the engine compartment	18
Relays in the passenger compartment	19
Relays in the cargo compartment	20
Ground connection	21
Control unit overview	24
Central Electronic Module CEM	26
Rear Electronic Module REM	28
Data communication	30

Group 23

Engine management system Denso	32
Engine management system ME7	34
Emission control Denso	36
Emission control ME7	37

Group 26

Electric cooling fan	38
----------------------------	----

Group 27

Cruise control	39
----------------------	----

Group 32

Power supply	40
--------------------	----

Group 33

Starting system	41
-----------------------	----

Group 35

High beam, low beam and auxiliary light wiring	42
Fog lights	43
Parking light, tail lights and license plate lighting	44
Brake lights	45
Reversing lights	46
Interior lighting	47

Group 36

Indicators and warning lights	48
Beam length adjustment	49
Instrument and control lighting	50
Safety lighting	51
Horn	52
Wiper/Washer, Windshield	53
Wiper/Washer, Headlights	54
Rain sensor	55
Cigarette lighter	56
Electronic immobilizer	57
Anti-theft alarm	58

Group 37

Diagnostics system	59
Towing bracket wiring	60
Auxiliary heater	61
Parking heater	61
12V outlet, cargo compartment	62
Seat belt reminder	63
Combined instrument panel	64
Radio without extra amplifier	65
Radio with extra amplifier	66
Road Traffic Information RTI	68
Mobile telephone	69

Group 43

Electronically controlled automatic transmission, AW 55-50	70
Geartronic	71
Shift lock	72

Group 59

ABS Brake system and STC	73
ABS Brake system and DSTC	74

Group 64

Electronic power steering	75
---------------------------------	----

Group 83

Power windows	76
Central lock	77

Group 84

Heated rear window	78
Power sunroof	79
Heated door mirrors	80
Power door mirrors	81

Group 85

Heated seats	82
Power driver's seat	83
Power passenger seat	84

Group 87

Standard heater	85
Manual climate control (MCC)	86
Electronic climate control (ECC)	87

Group 88

Electrically adjustable head restraint	88
Supplemental Restraint System (SRS)	89
Remote controlled garage opening	90

Connector

54/3LA - 54/3LB	91
54/3LC - 54/3LD	92
54/3LE - 54/3LF	93
54/3LG - 54/4	94
54/8 - 54/10	95

Order number TP 3955202
Replaces earlier book TP 3955201

54/11 - 54/12.....	96
54/13	97
54/14 - 54/16.....	98
54/20 - 54/21.....	99
54/24 - 54/25.....	100
54/40A - 54/40B.....	101
54/43A - 54/50.....	102
54/51 - 54/53.....	103
54/53 - 54/56.....	104

Junction points

53/301 - 53/328.....	105
53/329 - 53/360.....	106
53/365 - 53/403.....	107
53/405 - 53/430.....	108
53/431 - 53/448.....	109
53/500 - 53/519.....	110
53/520 - 53/531.....	111
53/532 - 53/625.....	112

Cable harness routing in vehicle

Engine harness.....	113
Engine compartment harness LHD.....	114
Engine harness.....	115
Passenger compartment harness, front LHD.....	116
Passenger compartment harness, front RHD.....	117
Passenger compartment harness, rear.....	118
Baggage compartment harness.....	119
Roof harness, boot lid/tailgate.....	120
Door harness.....	121

Pictures of components

1/1 - 2/52.....	122
2/58 - 2/90.....	123
2/91 - 2/119.....	124
2/120 - 3/25.....	125
3/26 - 3/78.....	126
3/80 - 3/127.....	127
3/130 - 4/7.....	128
4/9 - 4/70.....	129
4/71 - 6/15.....	130
6/16 - 6/37.....	131
6/38 - 6/95.....	132
6/96 - 7/15.....	133
7/16 - 7/73.....	134
7/74 - 7/122.....	135
7/123 - 7/159.....	136
8/3 - 8/41.....	137
8/44 - 9/2.....	138
9/12 - 10/14.....	139
10/15 - 10/50.....	140
10/51 - 10/125.....	141
10/126 - 11E.....	142
15/20 - 16/2.....	143
16/3 - 16/46.....	144
16/47 - 16/73.....	145
16/74 - 20/27.....	146
20/28 - 31/5.....	147
31/6 - 31/84.....	148
31/88 - 54/3.....	149
54/8 - 54/24.....	150
54/25 - 54/56.....	151

Groups

Group 23	= Fuel system
Group 26	= Cooling system
Group 27	= Engine controls
Group 32	= Generator and voltage regulator
Group 33	= Starting system
Group 35	= Lighting
Group 36	= Additional electrical equipment
Group 37	= Wiring and fuses
Group 43	= Transmission
Group 59	= Other
Group 64	= Steering
Group 83	= Doors and openings
Group 84	= Exterior decorative elements etc.
Group 85	= Interior equipment
Group 87	= Climate controls
Group 88	= Internal equipment

Ignition switch symbols

X	= Accessories (radio mode)
S	= Powered upon insertion of key
15	= The switch remains connected during start
15I	= Contact is broken while starting
30	= Constant power from the battery
50	= Start

Countries/Markets

A	= Austria
AUS	= Australia
B	= Belgium
CDN	= Canada
CH	= Switzerland
D	= Germany
DK	= Denmark
E	= Spain
EU/OS	= Markets outside USA and Canada
FIN	= Finland
GB	= Great Britain
ISR	= Israel
J	= Japan
KOR	= Korea
N	= Norway
NL	= Netherlands

S	= Sweden
USA	= USA
WEU	= Western Europe

Other

ABS	= Anti-lock Brake System
ACC	= Accessory
AMP	= With amplifier
AUDIO	= Radio
AUTO	= Automatic transmission
CEM	= Central electronic control unit
DENSO	= Fuel control system - gasoline, 5 cylinder
DSTC	= Dynamic Stability Traction Control
EXT.X	= Extended X feed
HISPEED	= High speed bus
LH	= Left-hand side
LHD	= Left-hand drive
LOSPEED	= Low speed bus
MAN	= Manual gearbox
ME7	= Fuel control system, gasoline, turbo 5 cyl.
REM	= Rear electronic control unit
RH	= Right-hand side
RHD	= Right-hand drive
RTI	= Road Traffic Information
SRS	= Airbag
STC	= Stability Traction Control
TELE	= Mobile telephone
TURBO	= Turbo engine
W/O	= Without

Colours

BL	= Blue
BN	= Brown
GN	= Green
GR	= Grey
OR	= Orange
P	= Pink
R	= Red
SB	= Black
VO	= Violet
W	= White
Y	= Yellow

How to use the wiring diagram

The descriptions below apply in general to all wiring diagram manuals, although not all sections are necessarily contained in this manual.

A. Component designation

Every component has a component designation that consists of two parts.

The first part is a type number that describes the type of component in question, for example 3/xx.

The second part of the designation is a serial number, for example, x/2.

Combined these give a component designation, for example, 3/2.

At the end of the manual is a list of components, where, with the help of the component designation, you can read off the name of the component, for example, 3/2 = light switch.

List of type numbers

The list shows which type of component that respective type numbers refer to, for example, 3/x = switch, 6/x = electric motor, etc.

1	Battery
2	Relay
3	Switch
4	Control unit
5	Combined instrument panel
6	Electric motor
7	Sensor
8	Actuator
9	Heating element
10	Light
11	Fuse
15	Distribution rail
16	Audio
17	Service/diagnosis
18	Contact reel
19	Meter
20	Ignition component/shunt
31	Ground connection
53	Junction point
54	Connector

B. Junction points

The wiring diagrams contain numbered junction points, e.g. 53/352.

This manual contains a section with a list of junction points. This list shows all the components which are connected to each junction point.

The location of the junction points is shown in the "Cable harness routing in vehicle" section.

C. Connectors

Connectors provide a bridge between two cables harnesses and are described in the "Connectors" section.

D. Electrical distribution

Operation of the fuses and relays is shown in the "Electrical distribution" section.

E. Data communication

Today's cars are equipped with a CAN network, which transmits information. Connections to this network are shown in their entirety on the respective wiring diagrams. Complete information on CAN communication can be found in the section titled "Data communication".

F. Abbreviations

A number of different abbreviations are used in the manual. These are explained in the section "Abbreviations".

G. Component location

There is a section at the end of the manual in which the appearance and location of components is described in numerical order.

Electrical distribution Overview

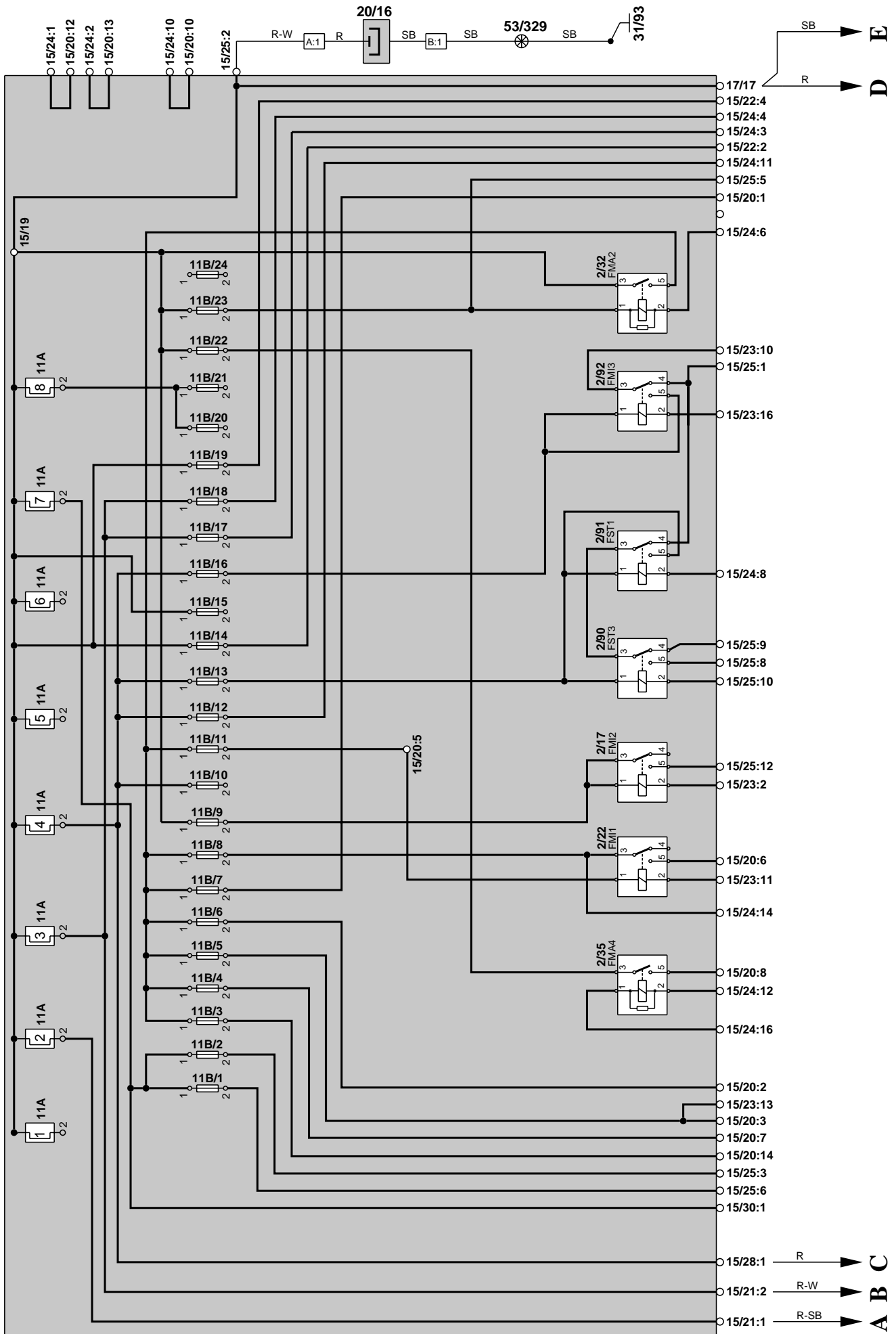

Electrical distribution Overview

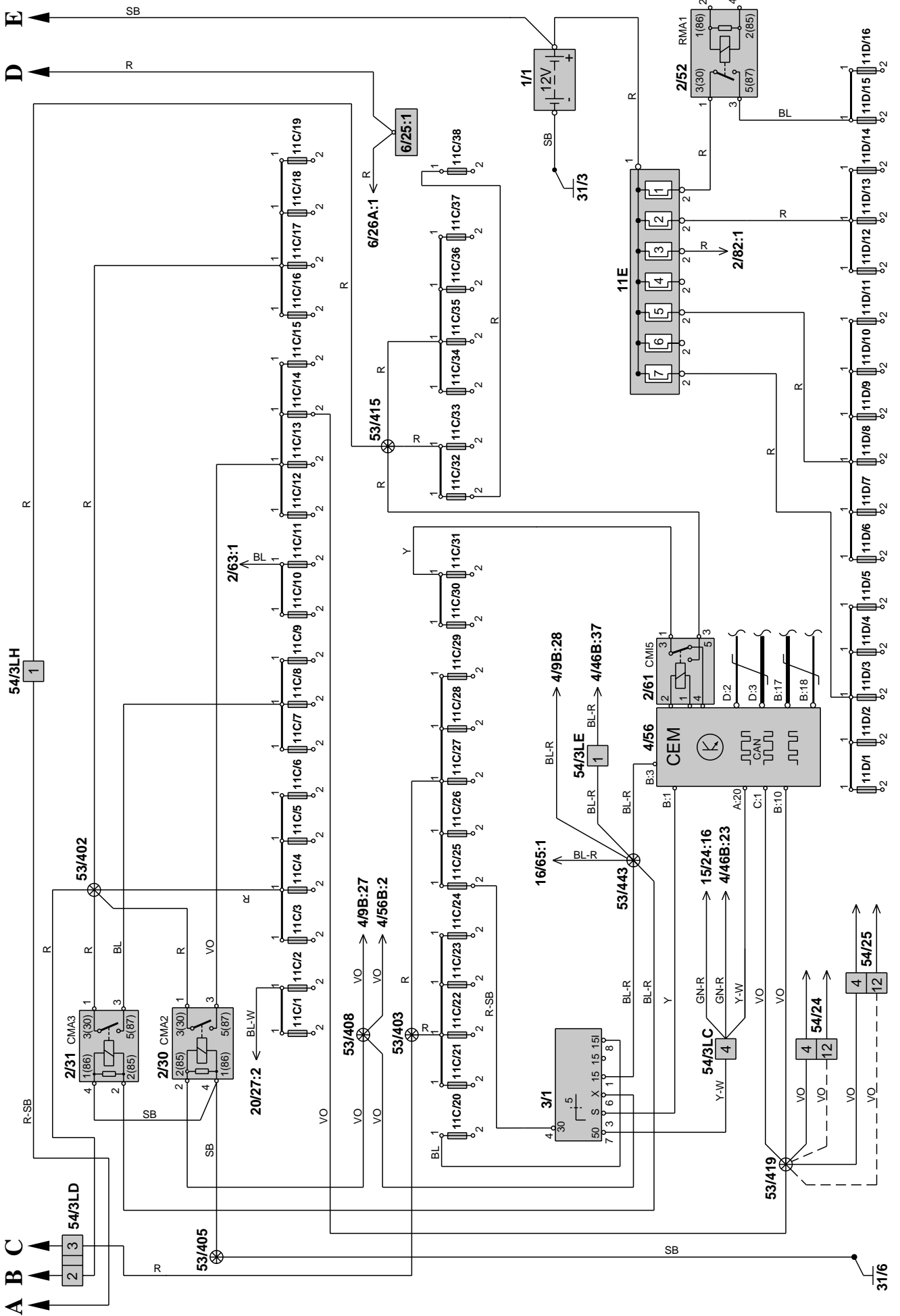

Electrical distribution

Fuses in the engine compartment

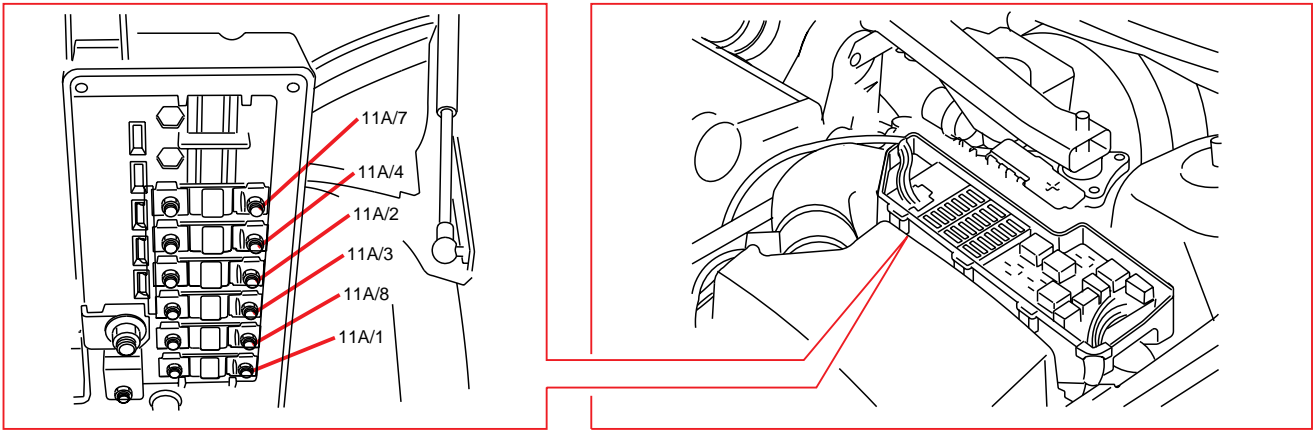

11A Fuses in the engine compartment

No.	Fuse function	A
2	Fuse protection for 11C/30-31 via overload relay 2/61 30+ Fuse protection for 11C/32-37	60
3	Fuse protection for 11B/17-18 Fuse protection for 11C/3-6 Fuse protection for 11C/16-19 Fuse protection for 11C/7-9 via overload relay 2/31 15+ Fuse protection for 11C/12-15 via overload relay 2/30 X+	60
4	Fuse protection for 11B/10, 12-13, 16 Fuse protection for 11C/21-24 Fuse protection for 11C/25-29	60
7	Motor, electric cooling fan 6/29 Fuse protection for 11B/1-2	60
8	Fuse protection for 11B/20-21	60

Electrical distribution Fuses in the engine compartment

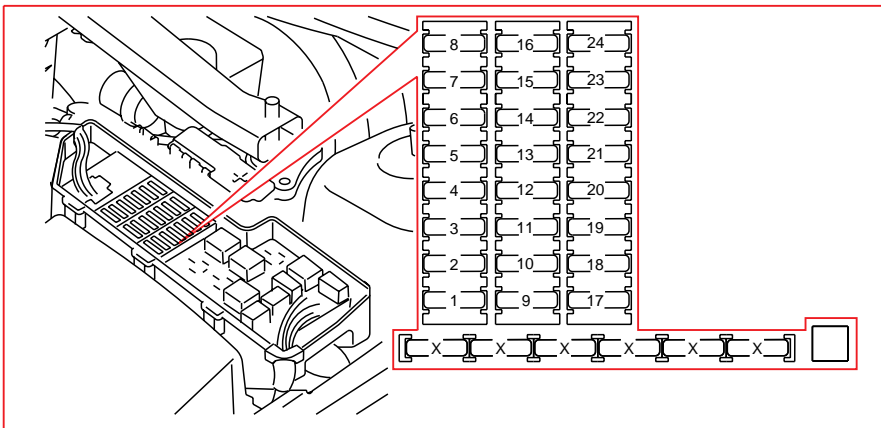

11B Fuses in the engine compartment

No.	Fuse function	A
1	Control unit CPM 4/7	25
2	Accessory (auxiliary light)	15
4	Heated oxygen sensor 7/15 Heated oxygen sensor diagnosis 1 7/82 Engine Control Module ECM 4/46	20
5	EVAP valve 8/18 Camshaft reset valve 8/19 Canister shut-off valve 8/44 PTC resistor - air preheating 9/32 Turbocharger control valve 8/28	15
6	Engine Control Module ECM 4/46 -injectors 8/6-10 -mass airflow sensor MAF 7/17	15
7	Control unit ETM 4/50	10
8	Solenoid switch AC 8/3 Accelerator pedal sensor 7/51	10
9	Horn relay 2/17	15
11	Spark plug and ignition coil 20/3-7 AC relay 2/22	20

continues

Electrical distribution

Fuses in the engine compartment

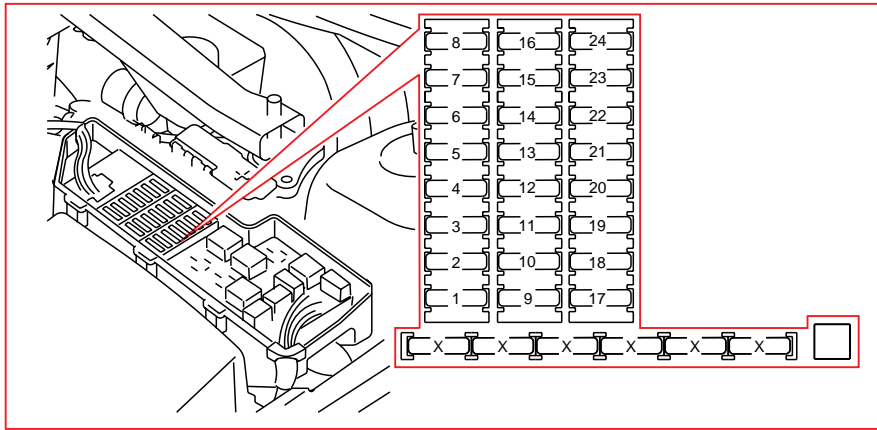

11B Fuses in the engine compartment

No.	Fuse function	A
12	Brake light contact 3/9	5
13	Relay, windshield wiper, low/high speed 2/90 Relay, intermittent windshield wiper 2/91	25
14	ABS control module 4/16	30
16	Relay, windshield washer motor 2/92	15
19	ABS control module 4/16	30
22	Starter motor 6/25	25
23	Engine control system main relay 2/32 Engine Control Module ECM 4/46	5

Electrical distribution Fuses in the passenger compartment

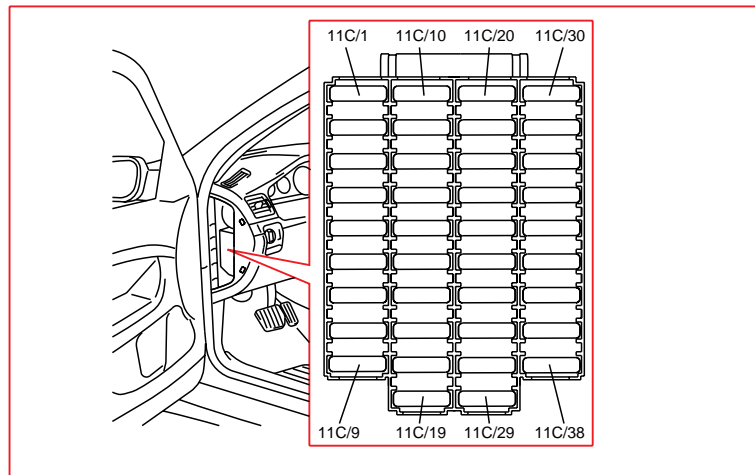

11C Fuses in the passenger compartment

No.	Fuse function	A
1	LH low beam 10/70	10
2	RH low beam 10/66	10
3	Fuse protection for 11C/1-2 via overload relay 2/62	15
4	Fuse protection for 11C/10-11 via overload relay 2/63	20
5	Driver seat motor, backrest angle 6/16 Driver seat motor, up/down front edge 6/17 Driver seat motor, up/down rear edge 6/18 Driver seat motor, forward/backward 6/19	30
6	Passenger seat motor, forward/backward 6/20 Passenger seat motor, backrest angle 6/64 Passenger seat motor, up/down front edge 6/65 Passenger seat motor, up/down rear edge 6/66	30
7	LH seat heater 9/12	15
8	RH seat heater 9/13	15
9	ABS control module 4/16 Steering wheel angle sensor control unit 4/68	5
10	LH high beam 10/68	15
11	RH high beam 10/64	15

continues

Electrical distribution

Fuses in the passenger compartment

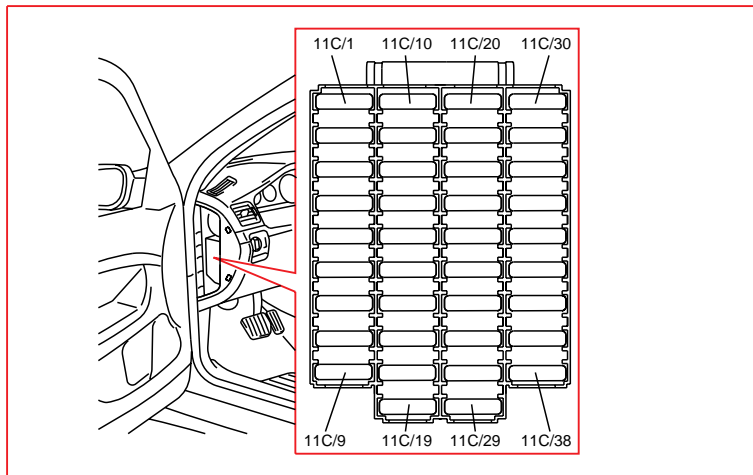

11C Fuses in the passenger compartment

No.	Fuse function	A
12	Headlight wiper motor, right/left 6/3-4 Headlight positioning motor, right/left 6/38-39	15
13	Front 12V outlet 9/1 Cigarette lighter/12V outlet, rear 9/25	20
14	Switch, seat belt latch left seat 3/93 Switch, seat belt latch left seat 3/94 CEM 4/56 Passenger seat motor, forward/backward 6/20 Passenger seat motor, backrest angle 6/64 Passenger seat motor, up/down front edge 6/65 Passenger seat motor, up/down rear edge 6/66	5
15	Radio 16/1 RTI Display 16/46	5
16	Radio 16/1	20
17	Amplifier 16/2	30
18	Foglight front left 10/5 Foglight front right 10/6	15
19	RTI Display 16/46	10
21	Automatic transmission program selector 3/155 Automatic transmission 8/37	10
22	LH front indicator 10/13 RH front indicator 10/14	20

continues

Electrical distribution Fuses in the passenger compartment

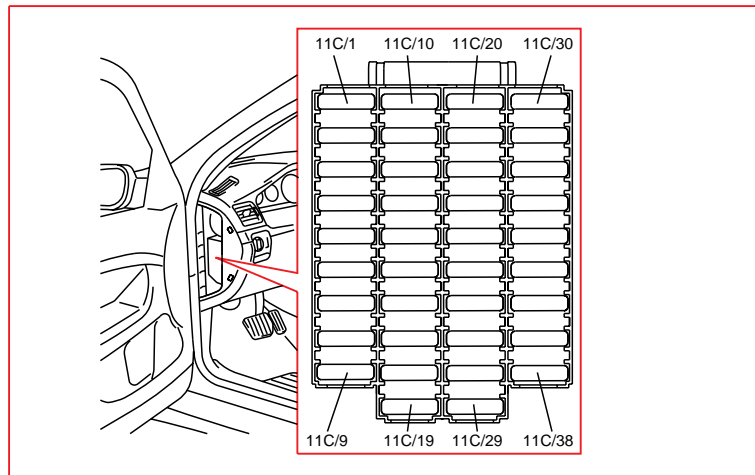

11C Fuses in the passenger compartment

No.	Fuse function	A
23	Data link connector 17/13 Light Switch Module LSM 3/111 Climate Control Module CCM 3/112 Steering Wheel Module SWM 3/130	5
24	Control unit CPM 4/7	10
25	Ignition switch 3/1	10
26	Fan control module 4/31	30
27	Control unit left front door DDM/PDM 3/126 Control unit right front door PDM/DDM 3/127	15
28	Upper Electronic Module UEM 4/70	10
29	Mobile telephone 16/60	10
30	LH front parking light 10/11 EU/OS LH front parking light 10/129 USA/CDN LH brake light 1 10/51 LH brake light 2 10/52	10

continues

Electrical distribution

Fuses in the passenger compartment

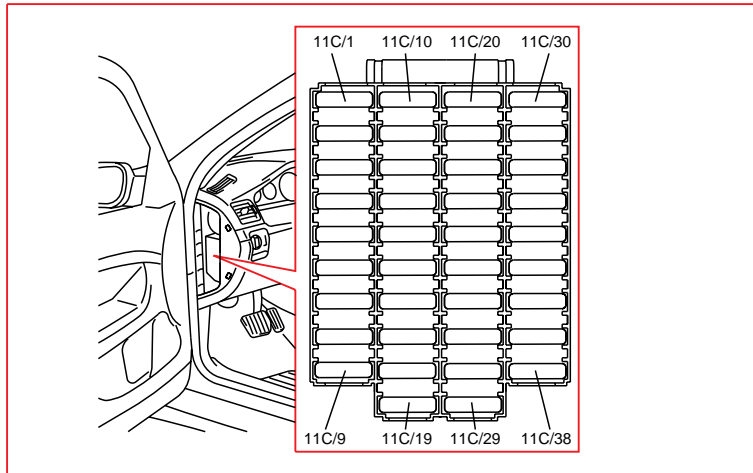

11C Fuses in the passenger compartment

No.	Fuse function	A
31	RH front parking light 10/12 EU/OS RH front parking light 10/130 USA/CDN Tail light 1 right 10/44 Parking light, RH rear 10/42 Tail light 2 right 10/45 Parking light, LH rear 10/49 Connector 54/51 License plate lighting 10/3	10
32	CEM 4/56	10
33	Fuel pump 6/33	15
34	Control unit SRM 4/33	15
35	Control unit left front door DDM/PDM 3/126	25
36	Control unit right front door PDM/DDM 3/127	25
37	Electric rear window motor, left rear 6/92 Electric rear window motor, right rear 6/93	30
38	Alarm siren SCM 16/35	5

Electrical distribution Fuses in cargo compartment

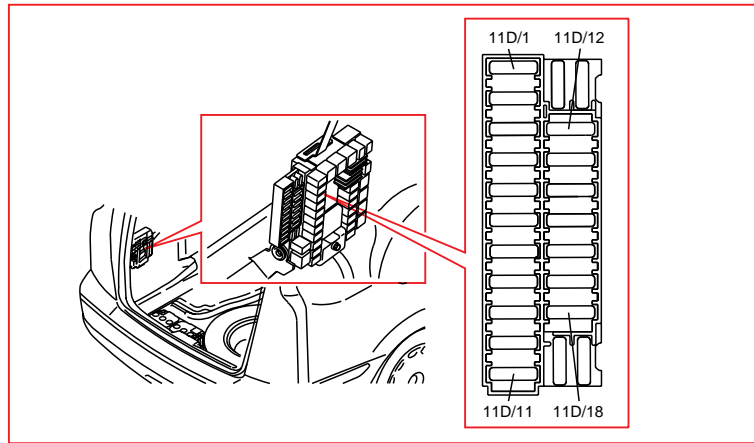

11D Fuses in the cargo compartment

No.	Fuse function	A
1	REM 4/58	10
2	Fog light, left rear 10/53 Fog light, right rear 10/46	10
3	RH brake light 10/43 LH brake light 10/50 Connector 54/51	15
4	RH reversing light 10/48 LH reversing light 10/55 Connector 54/51	10
5	Relay, 15 feed, rear accessories 2/52 Heated rear window 9/2 Window antenna amplifier, left 16/16	5
6	Trunk lid/tailgate lock unit 3/78	10
7	LH rear headrest solenoid 8/59 RH rear headrest solenoid 8/60	10
8	Rear door lock unit, left/right 3/76-77 Locking motor, fuel filler flap 6/37	15
9	Towing bracket wiring	15
10	CD changer 16/15 RTI CD-ROM player 16/48 RTI control module 16/45 Pager alarm 4/79	10
16	12V outlet, cargo compartment 17/19	15

Electrical distribution

Fuses in cargo compartment

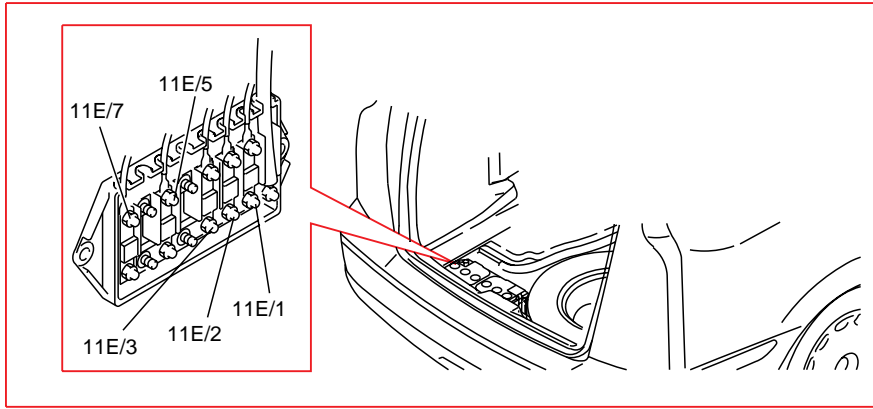

11E Fuses by the battery

No.	Fuse function	A
1	Relay, 15 feed, rear accessories 2/52	40
2	Fuse protection for 11D/12-14	40
3	Relay, heated rear window 2/82	40
5	Fuse protection for 11D/6-11	40
7	Fuse protection for 11D/1-5	40

Electrical distribution Ignition switch with relays

3/1

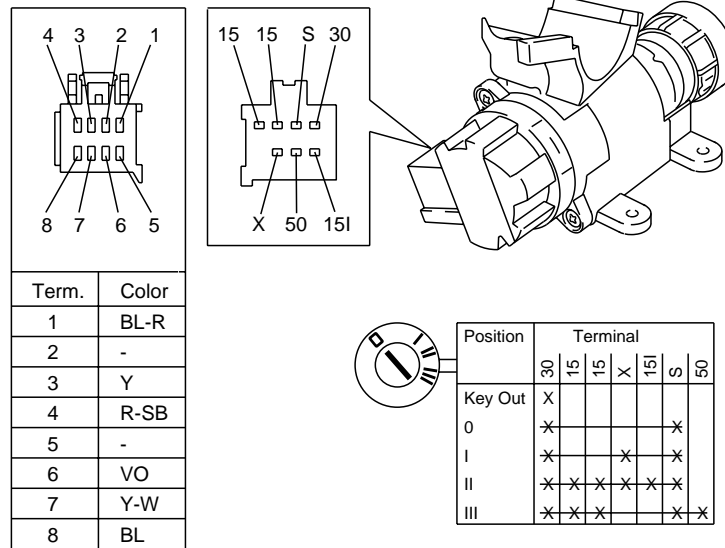

Relays, general

The diagram indicates two or three different designations for the relay's position. This is described below.

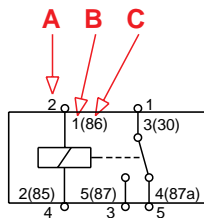

A = Corresponds to the position on the rear of the relay box (wiring side).

B = Corresponds to the position on the relay.

C = Is an old designation that can be on the relay.

Electrical distribution

Relays in the engine compartment

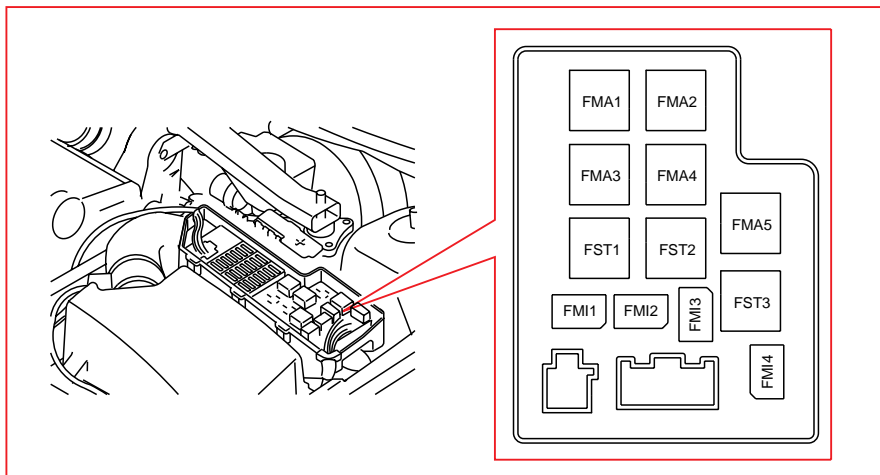

Relays in the engine compartment

Pos	Relay function
FMA2	Engine control system main relay 2/32
FMA4	Starter motor relay 2/35
FMI1	AC relay 2/22
FMI2	Horn relay 2/17
FMI3	Relay, windshield washer motor 2/92
FST1	Relay, intermittent windshield wiper 2/91
FST2	-
FST3	Relay, windshield wiper, low/high speed 2/90

Other relays

Pos	Relay function
LH rear door	Deadlock relay, LH rear door 2/138
RH rear door	Deadlock relay, RH rear door 2/139

Electrical distribution Relays in the passenger compartment

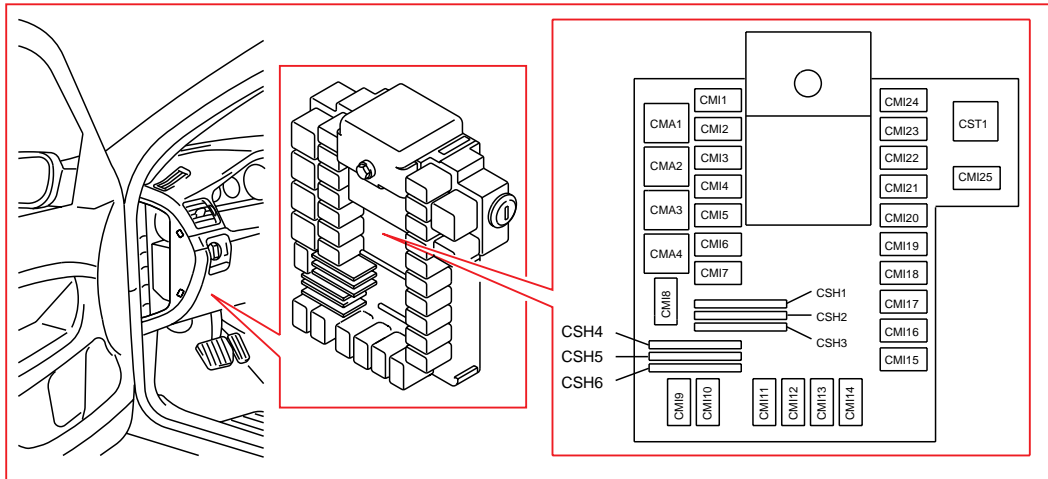

Relays in the passenger compartment

Pos	Relay function
CMA2	X-feed overload relay 2/30
CMA3	15-feed overload relay 2/31
CMI1	Rear left power window up relay 2/116
CMI2	Rear left power window down relay 2/118
CMI3	Power window relay, child lock rear door 2/120
CMI4	High beam relay 2/63
CMI5	Parking light relay 2/61
CMI7	Low beam relay 2/62
CMI11	Fog light relay, front 2/34
CMI12	Fuel pump relay 2/23
CMI21	Relay for extended X feed, automatic transmission 2/101
CMI22	Extended X feed relay 2/29
CMI23	Right rear power window down relay 2/119
CMI24	Right rear power window up relay 2/117
CSH1	LH turn signal shunt CEM 20/32
CSH2	RH turn signal shunt CEM 20/34
CSH4	Shunt, low beam CEM 20/27

Electrical distribution

Relays in the cargo compartment

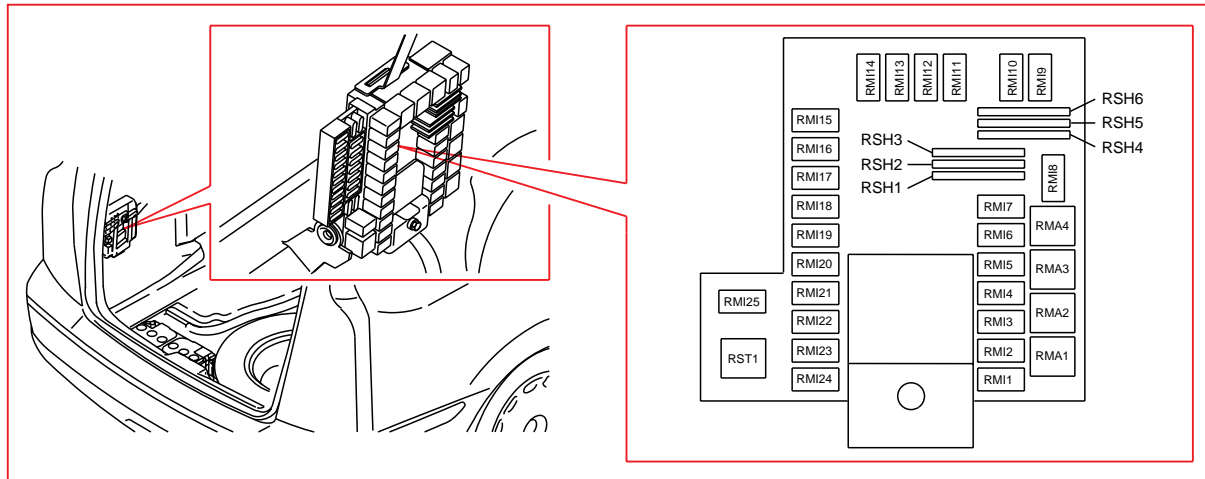

Relays in the cargo compartment

Pos	Relay function
RMA1	Relay, 15 feed, rear accessories 2/52
RMA3	Relay, heated rear window 2/82
RMI1	Locking relay, LH rear 2/111
RMI2	Unlocking relay, LH rear 2/112
RMI3	Relay, deadlock, rear doors 2/115
RMI4	Reversing light relay 2/80
RMI5	Brake light relay 2/79
RMI6	Relay, rear fog light 2/49
RMI7	Trailer fog light relay 2/83
RMI11	Relay, pager alarm 1 2/136 ISR
RMI12	Relay, pager alarm 2 2/137 ISR
RMI14	Rear adjustable head restraint relay 2/75
RMI20	Trunk lid opening relay 2/67
RMI21	Unlocking relay, fuel filler flap 2/59
RMI22	Locking relay, fuel filler flap 2/58
RMI23	Unlocking relay, RH rear 2/114
RMI24	Locking relay, RH rear 2/113
RSH2	Shunt, low beam REM 20/29
RSH4	Shunt, parking light REM 20/28
RSH5	Shunt, parking light/tail light REM 20/33
RSH6	Shunt, brake light REM 20/31

Electrical distribution Ground connection

31/1
RH headlight wiper motor 6/3:3
Coolant level sensor 7/73:2
Windshield washer pump 6/2:4

31/2
Electric cooling fan control module 4/71A:2

31/3
Battery 1/1

31/4
Ground connection engine - body 31/44

31/5
Heated rear window 9/2:2

31/6
Central Electronic Module CEM 4/56E:1 LHD
Fan control module 4/31A:4 RHD
Junction point 53/405 <ul style="list-style-type: none"> - X feed overload relay 2/30:4 - 15-feed overload relay 2/31:4 - hazard warning flasher switch 3/6:5 - antenna ring/ignition switch lighting 16/65:6 - courtesy lighting, left front 10/125:4 - connector 54/13:22 - glove compartment lighting 10/29:2 RHD

31/10
Control unit, ventilation fan 4/31A:4 LHD
Central Electronic Module (CEM) 4/56E:1 RHD
Junction point 53/406 <ul style="list-style-type: none"> -cigarette lighter/12V outlet, rear 9/25:3 -courtesy lighting, right front 10/126:4 -front 12V outlet 9/1:2 - glove compartment lighting 10/29:2 LHD

31/44
Ground connection, LH side member 31/4

31/47
Fuel pump 6/33:4

31/66
Connector 54/10:12 RHD
Junction point 53/510 LHD <ul style="list-style-type: none"> - connector 54/10:12 LHD - power driver seat module PSM 4/52B:4 LHD
Junction point 53/500 <ul style="list-style-type: none"> - power driver seat module PSM 4/52A:2 LHD - connector 54/10:11 - connector 54/20:12 - connector 54/24:13 RHD - connector 54/24:3

Electrical distribution

Ground connection

31/67
Junction point 53/511 - power driver seat module PSM 4/52B:4 RHD - connector 54/11:12 RHD
Connector 54/11:12 LHD
Junction point 53/501 - power driver seat module PSM 4/52A:2 RHD - connector 54/11:11 - connector 54/21:12 - connector 54/25:13 LHD - connector 54/25:3

31/72
Junction point 53/601 - lighting, cargo compartment, LH side 10/127:4 - LH rear headrest solenoid 8/59:4 - Rear Electronic Module (REM) 4/58E:1 - LH tail light housing 10/18A:4 - LH tail light housing 10/18B:1 - connector 54/50:10
Junction point RTI 53/602 - vehicle inclination sensor ISM 7/100:5 - pager alarm 4/79:4 ISR - RTI control module 16/45A:11 - CD-ROM player RTI 16/48:1 - CD changer 16/15:1 - relay, pager alarm 1 2/136:1 ISR - relay, pager alarm 2 2/137:1 ISR
Vehicle inclination sensor ISM 7/100:5 without RTI ISR

31/73
Junction point 53/604 - RH rear headrest solenoid 8/60:4 - lamp housing, RH tail light 10/17A:4 and 10/17B:1 - lighting, cargo compartment, RH side 10/128:4
Connector 54/51:7
12V outlet, cargo compartment 17/19:2 Accessory

31/83
Junction point 53/400 - combined instrument panel DIM 5/1:14 DIM - antenna ring/ignition switch lighting 16/65:7 - connector 54/13:20

31/84
Junction point 53/438 - light switch module LSM 3/111:5 - Steering Wheel Module SWM 3/130:22 - Steering Wheel Module SWM 3/130:16 - Climate Control Module CCM 3/112A:16 - steering wheel angle sensor control unit 4/68:16 DSTC - Data link connector 17/13:4 and 17/13:5 - mobile telephone 16/60:18
Radio 16/1A:12 without amplifier
Junction point 53/448 - radio 16/1A:12 amplifier - amplifier 16/2A:2 - junction point RTI 53/423

31/88
Spark plug and ignition coil 1 20/3:3
Spark plug and ignition coil 2 20/4:3

31/89
Spark plug and ignition coil 3 20/5:3
Spark plug and ignition coil 4 20/6:3
Spark plug and ignition coil 5 20/7:3

Electrical distribution Ground connection

31/91
Control unit ETM 4/50:5
PTC resistor - air preheating 9/32:2 Turbo

31/93
Junction point 53/329 <ul style="list-style-type: none"> - accelerator pedal sensor 7/51:3 - brake fluid level sensor 7/4:2 - stepper motor, speed-dependent power steering Stepper motor, speed-dependent power steering 6/71:6 - reversing light contact 3/10:2 - capacitor 20/16:1B
Junction point 53/331 <ul style="list-style-type: none"> - windshield wiper motor 6/1:4 - connecting rail 15/25:1 - connector 54/4:4 - connector 54/9:3 - LH headlight wiper motor 6/4:3 - automatic transmission solenoids 8/37B:2 and 8/37B:4
Junction point 53/301 <ul style="list-style-type: none"> - foglight front left 10/5:2 - LH front lamp housing 10/1B:3 - LH front lamp housing 10/1A:1 - LH headlight level adjustment motor 6/38:1 - LH front fender turn signal 10/15:1 EU/OS

31/94
Transmission Control Module TCM 4/28A:53
Junction point 53/303 <ul style="list-style-type: none"> - alarm siren SCM 16/35:3 - RH headlight adjustment motor 6/39:1 - RH front lamp housing 10/2A:1 - RH front lamp housing 10/2B:3 - foglight front right 10/6:2 - RH front fender turn signal 10/16:1 EU/OS

31/95
Junction points 53/384 <ul style="list-style-type: none"> - ABS control module 4/16:8 - ABS control module 4/16:24 - ABS control module 4/16:15 DSTC - ABS control module 4/16:46 DSTC

31/96
Junction point 53/326 <ul style="list-style-type: none"> - Engine Control Module ECM 4/46A:36 - Engine Control Module ECM 4/46A:53 - Engine Control Module ECM 4/46A:54 - Engine Control Module ECM 4/46A:62

31/98
RH vanity mirror lighting 10/115:3
Junction point 53/503 <ul style="list-style-type: none"> - LH vanity mirror lighting 10/114:3 - rear reading light 10/150:4 - Microwave Motion Sensor (MMS) alarm 7/122:5 - Upper Electronic Module UEM 4/70:20 - dome light control module 3/117:10A - control unit SRM 4/33:5 - auxiliary brake light 10/19:5 - connector 54/13:20

Control unit overview

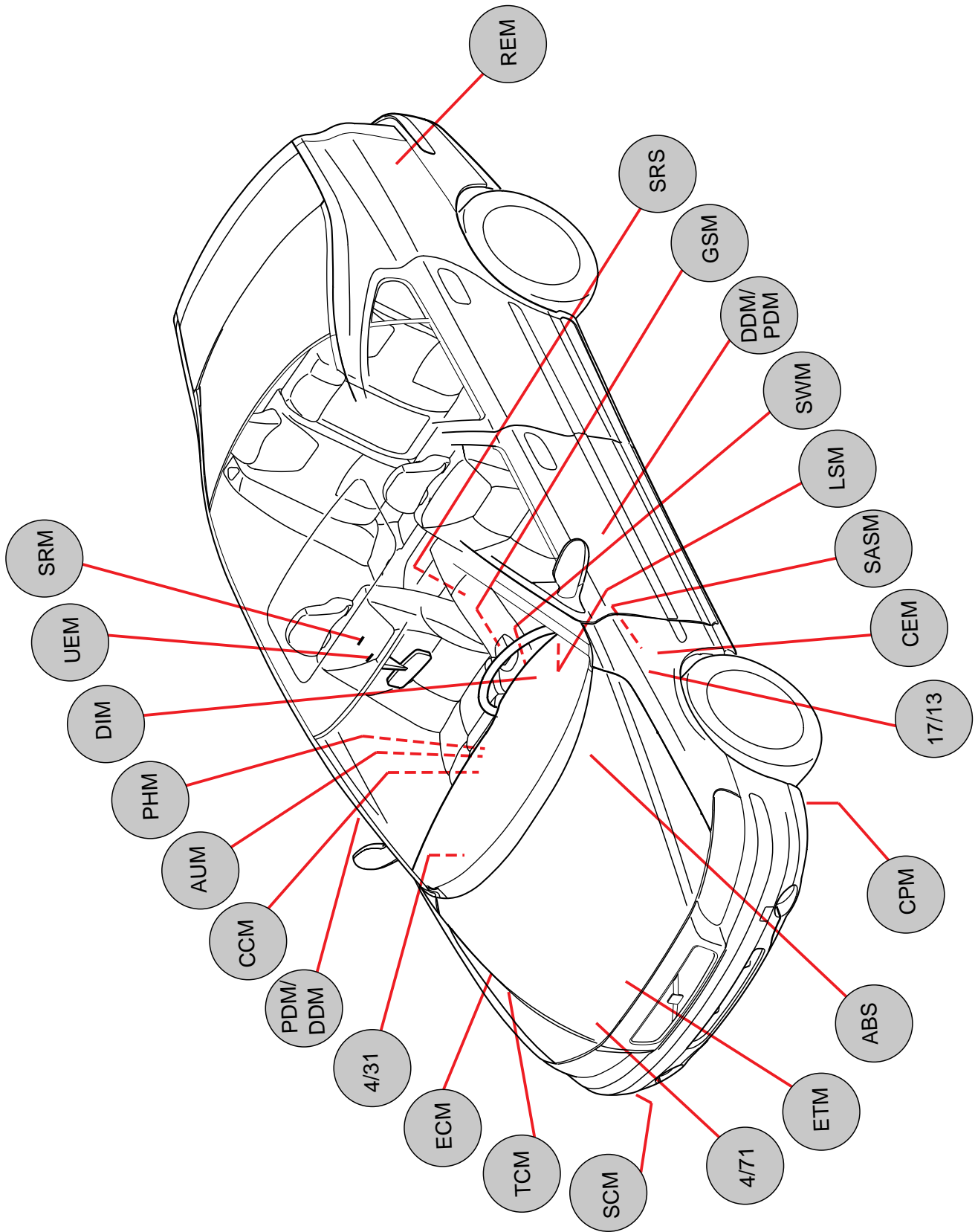

Control unit overview

Unit	Designation
ABS	ABS control module 4/16
AUM	Radio 16/1
CCM	Climate Control Module CCM 3/112
CEM	Central Electronic Module, CEM 4/56
CPM	Control unit CPM 4/7
DIM	Combined instrument panel DIM 5/1
ECM	Engine Control Module ECM 4/46
ETM	Control unit ETM 4/50
GSM	Fan switch 3/56
LSM	Light Switch Module LSM 3/111
PDM/ DDM	Control unit right front door PDM/DDM 3/127
DDM/ PDM	Control unit left front door DDM/PDM 3/126
PHM	Mobile telephone 16/60
REM	Rear Electronic Module REM 4/58
SASM	Steering wheel angle sensor control unit 4/68
SCM	Alarm siren SCM 16/35
SRM	Sunroof control module 4/33
SRS	Control unit, Supplementary Restraint System (SRS)
SWM	Steering Wheel Module SWM 3/130
ICM	Control unit TCM 4/28
UEM	Upper Electronic Module UEM 4/70
4/31	Fan control module 4/31
4/71	Cooling fan control module 4/71
17/13	Data link connector 17/13

Electrical distribution

Central Electronic Module CEM

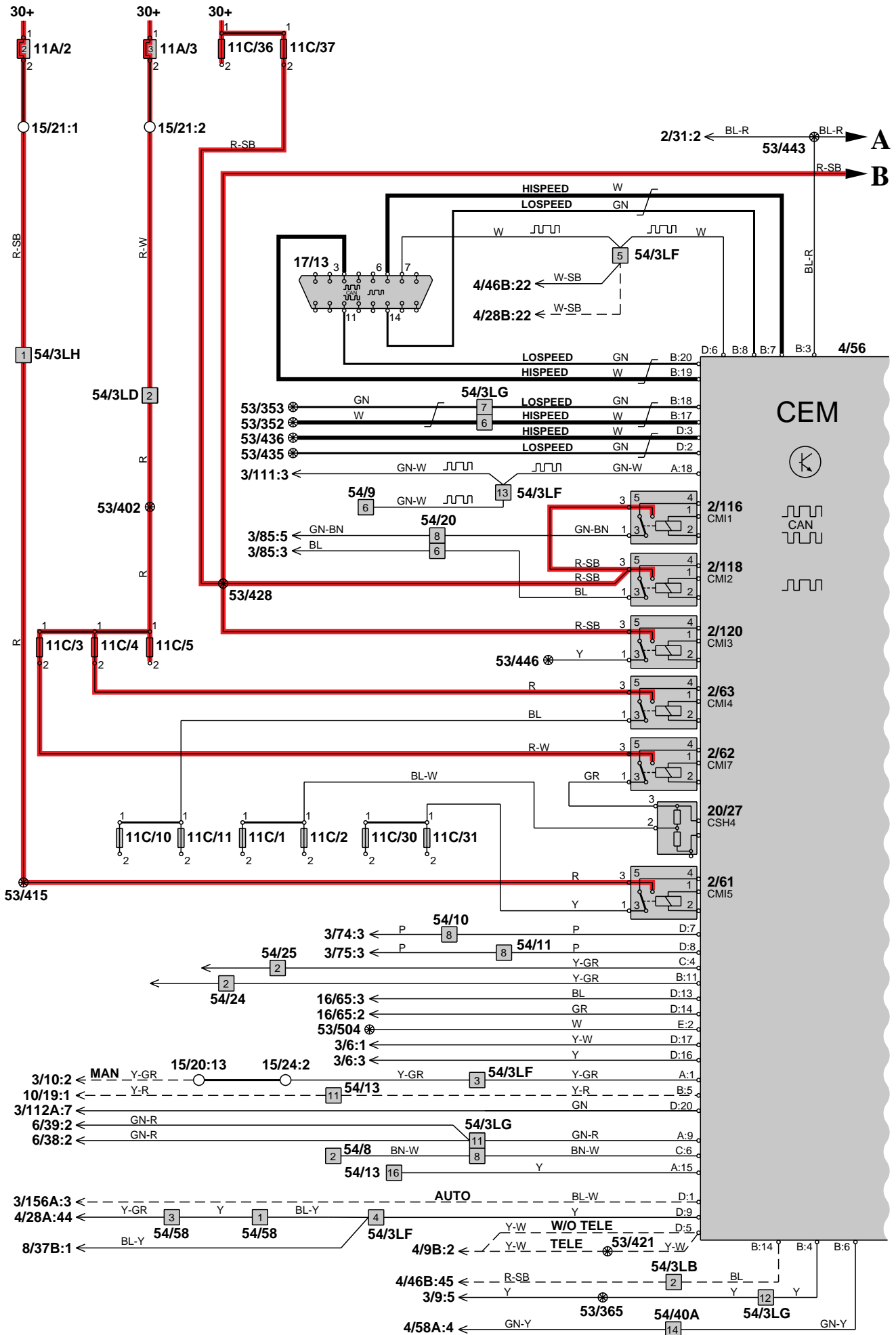

Electrical distribution Central Electronic Module CEM

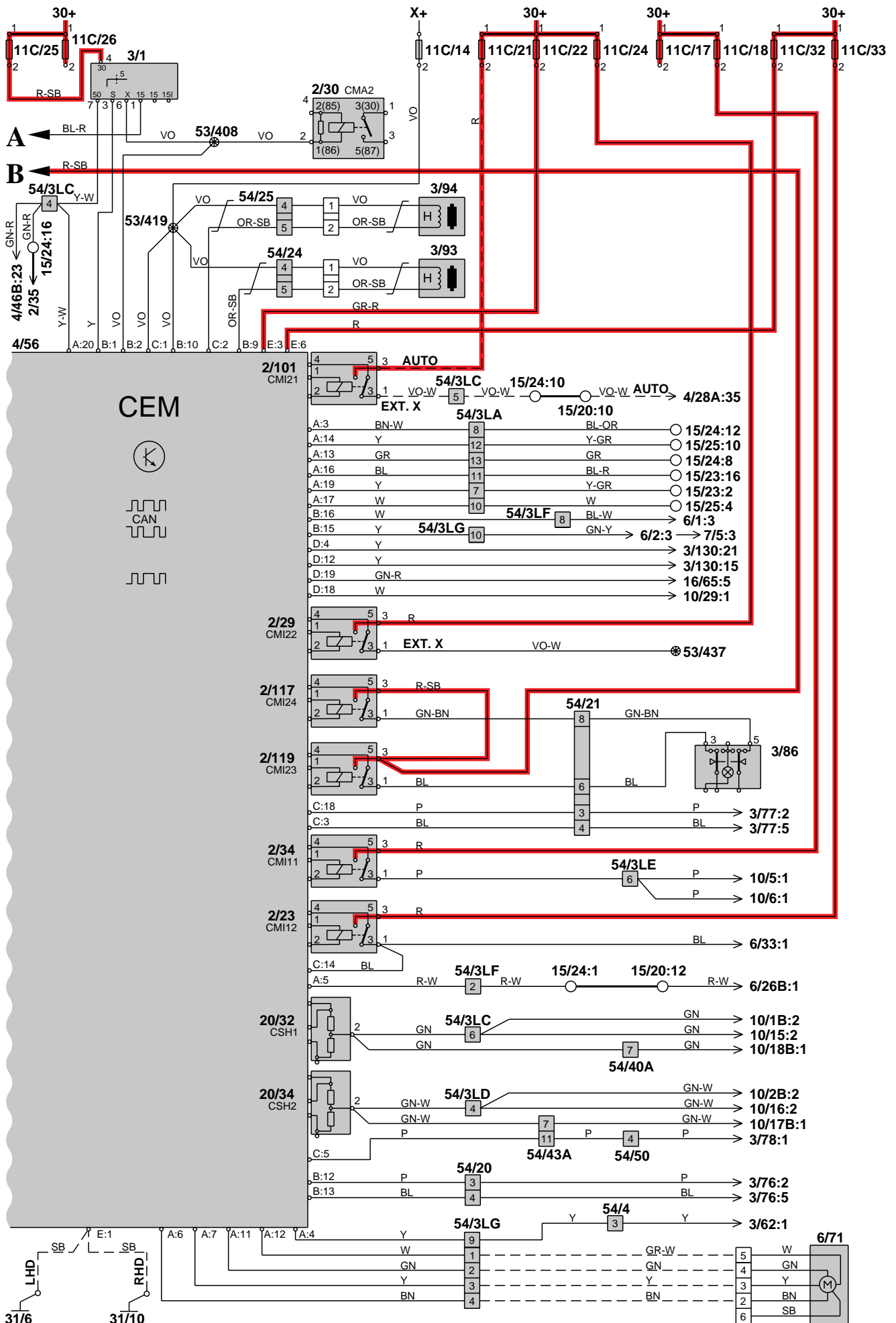

Electrical distribution

Rear Electronic Module REM

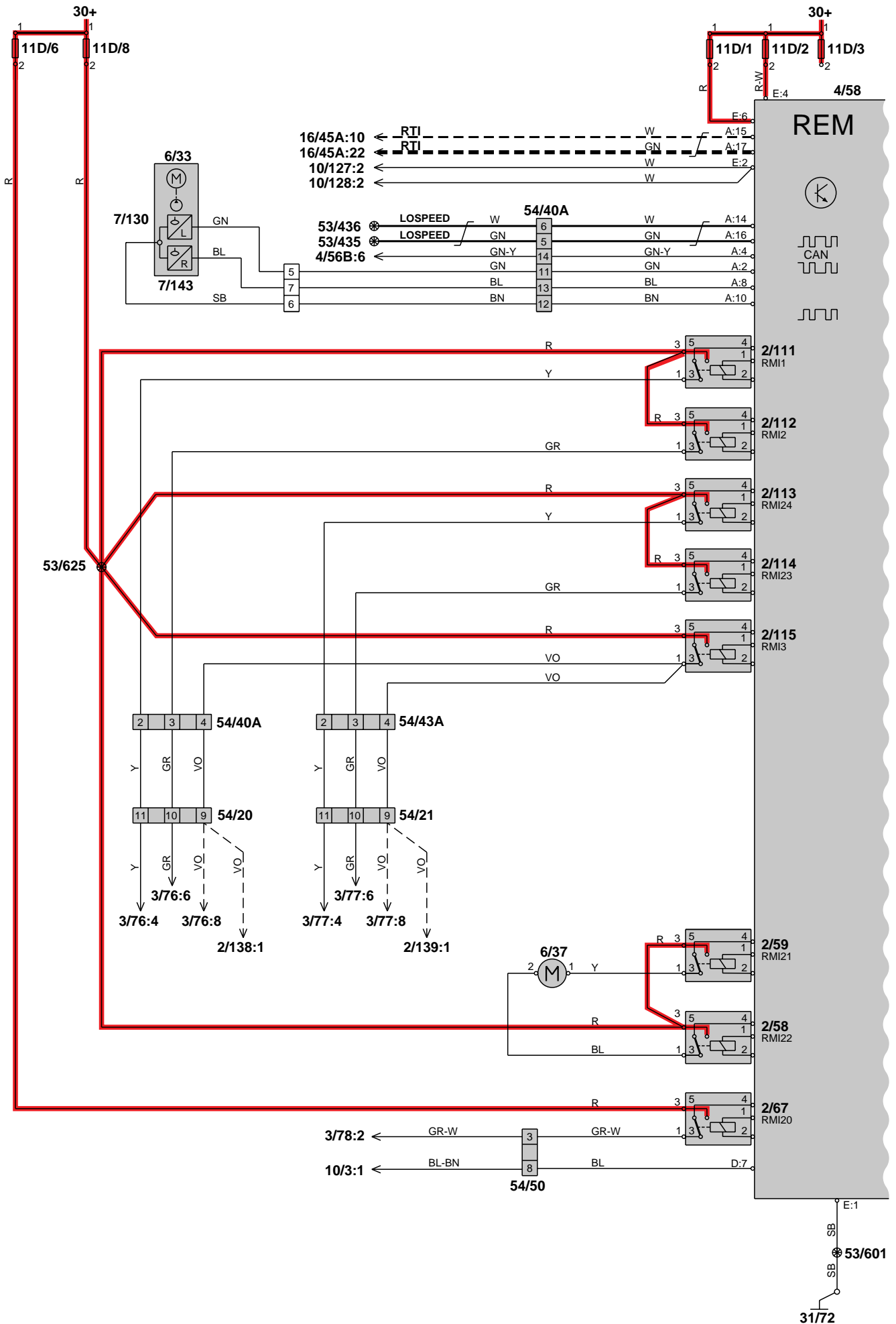

Electrical distribution Rear Electronic Module REM

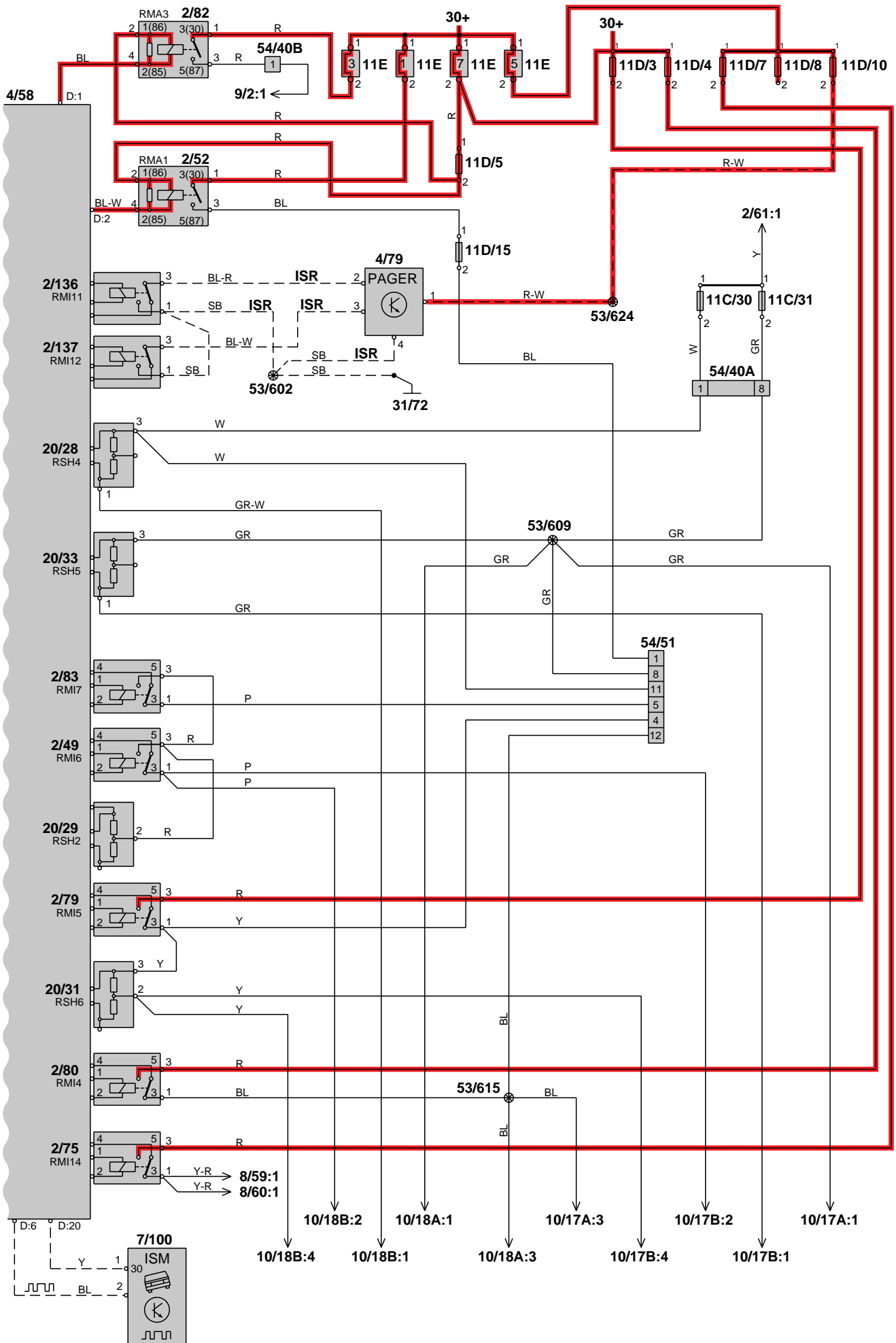

Electrical distribution

Data communication

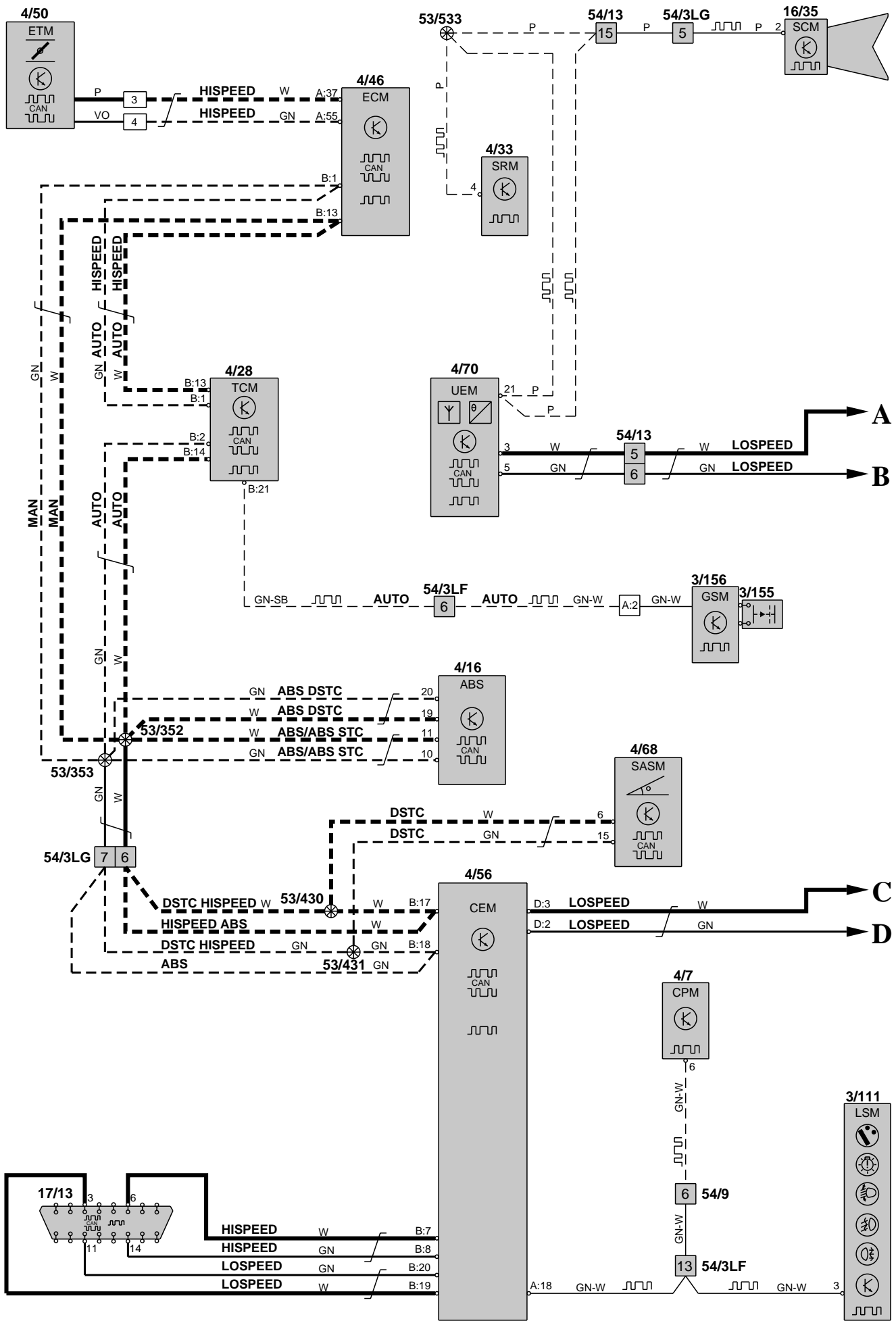

Electrical distribution Data communication

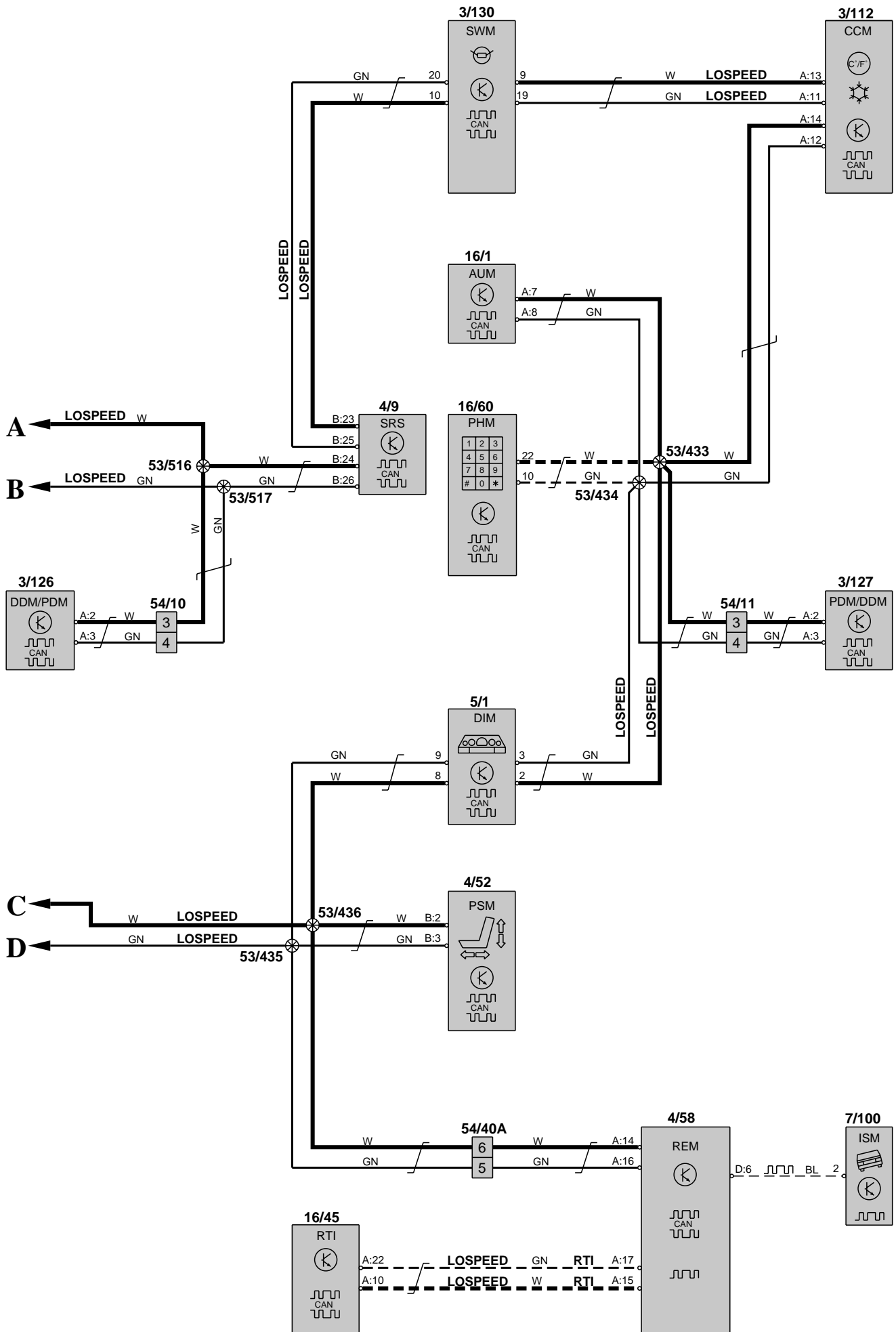

Group 23 Engine management system Denso

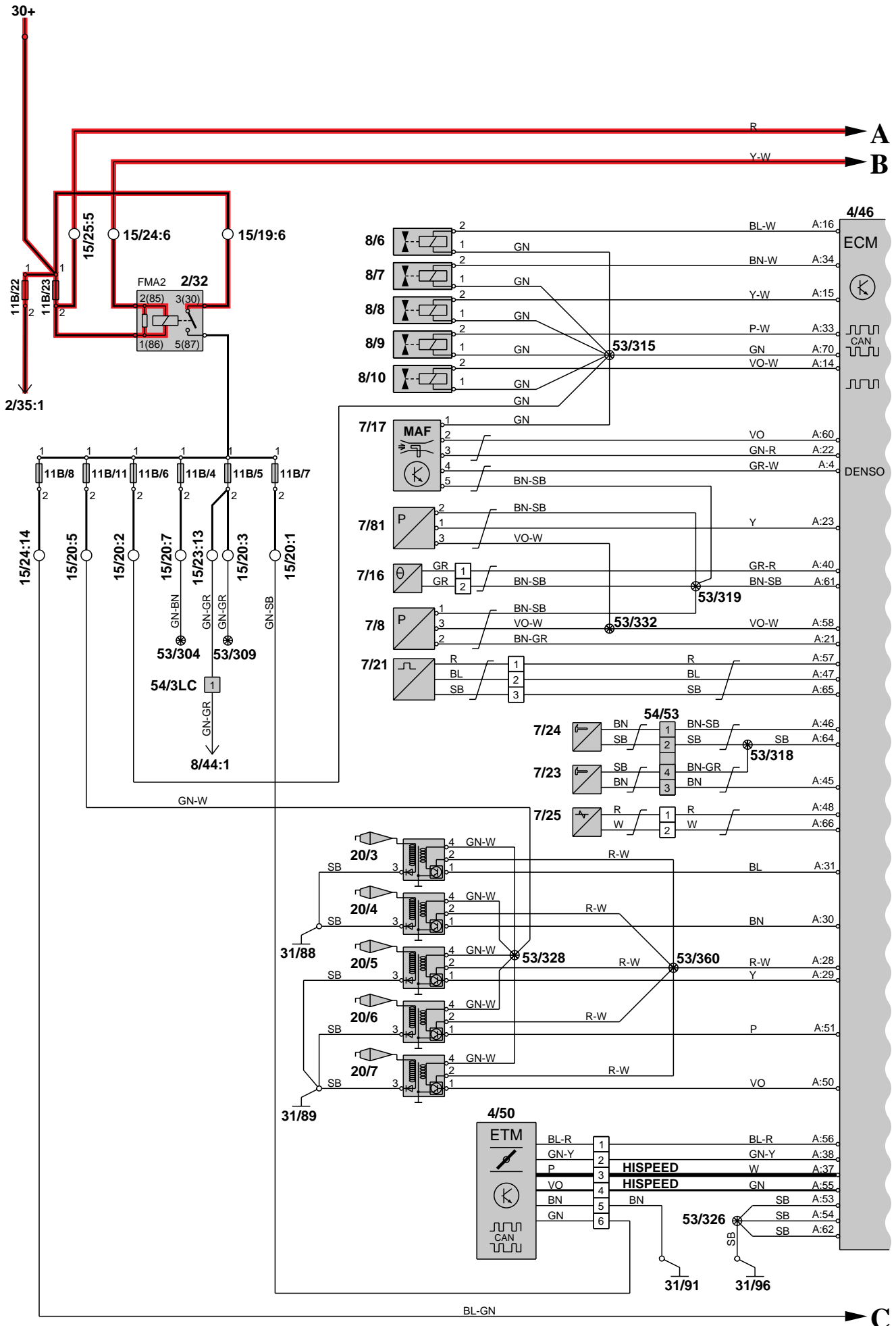

Engine management system ME7

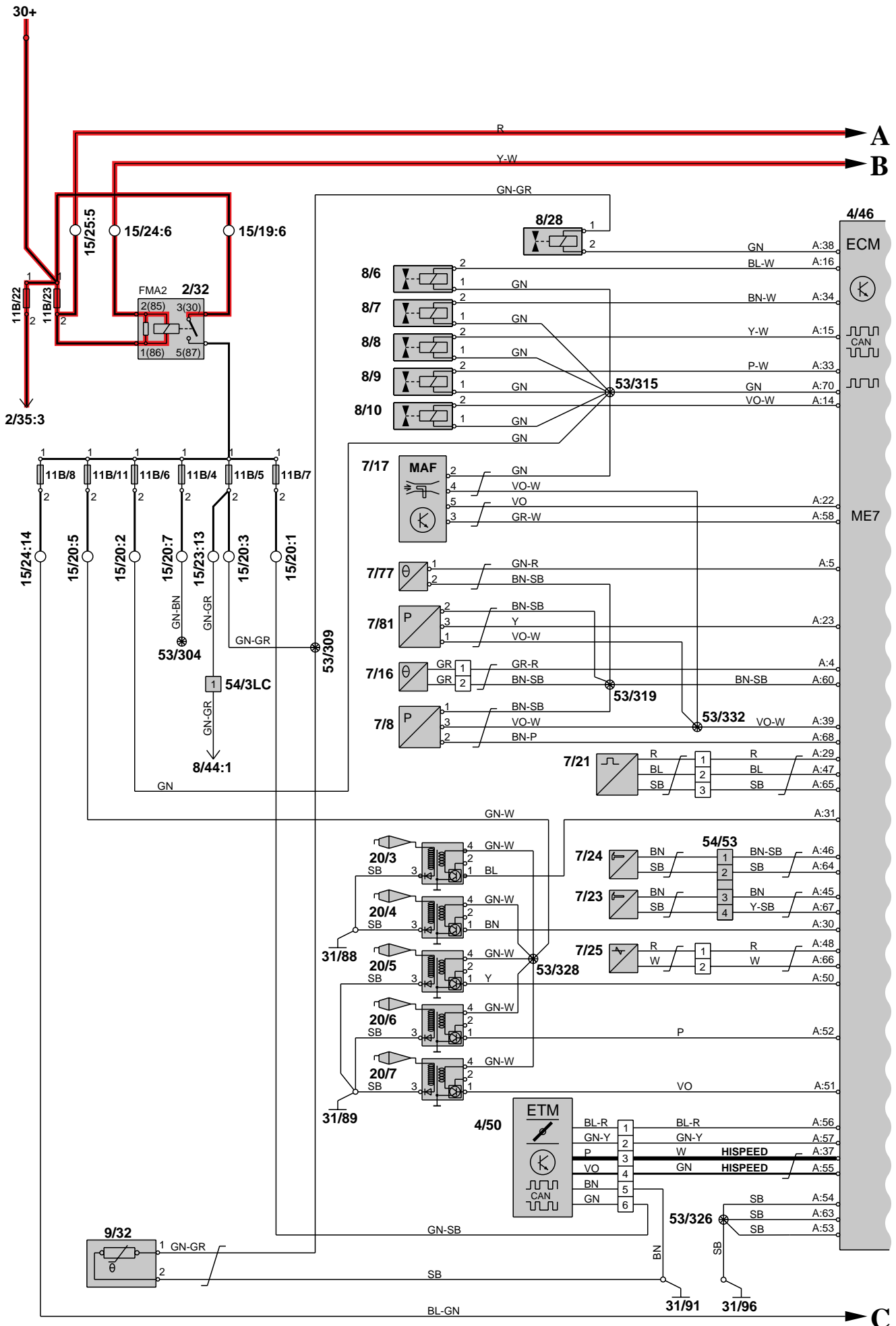

Engine management system ME7

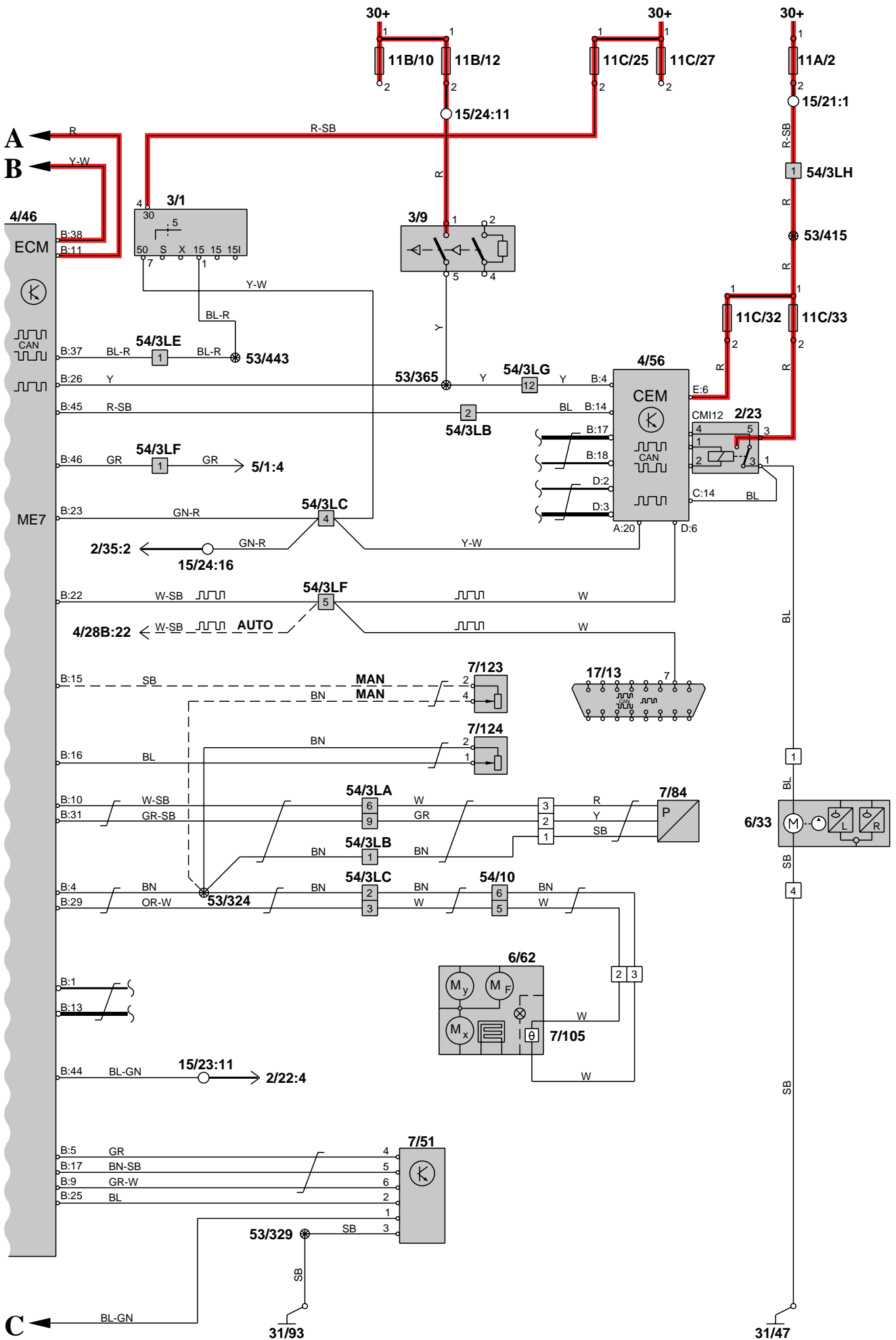

Emission control ME7

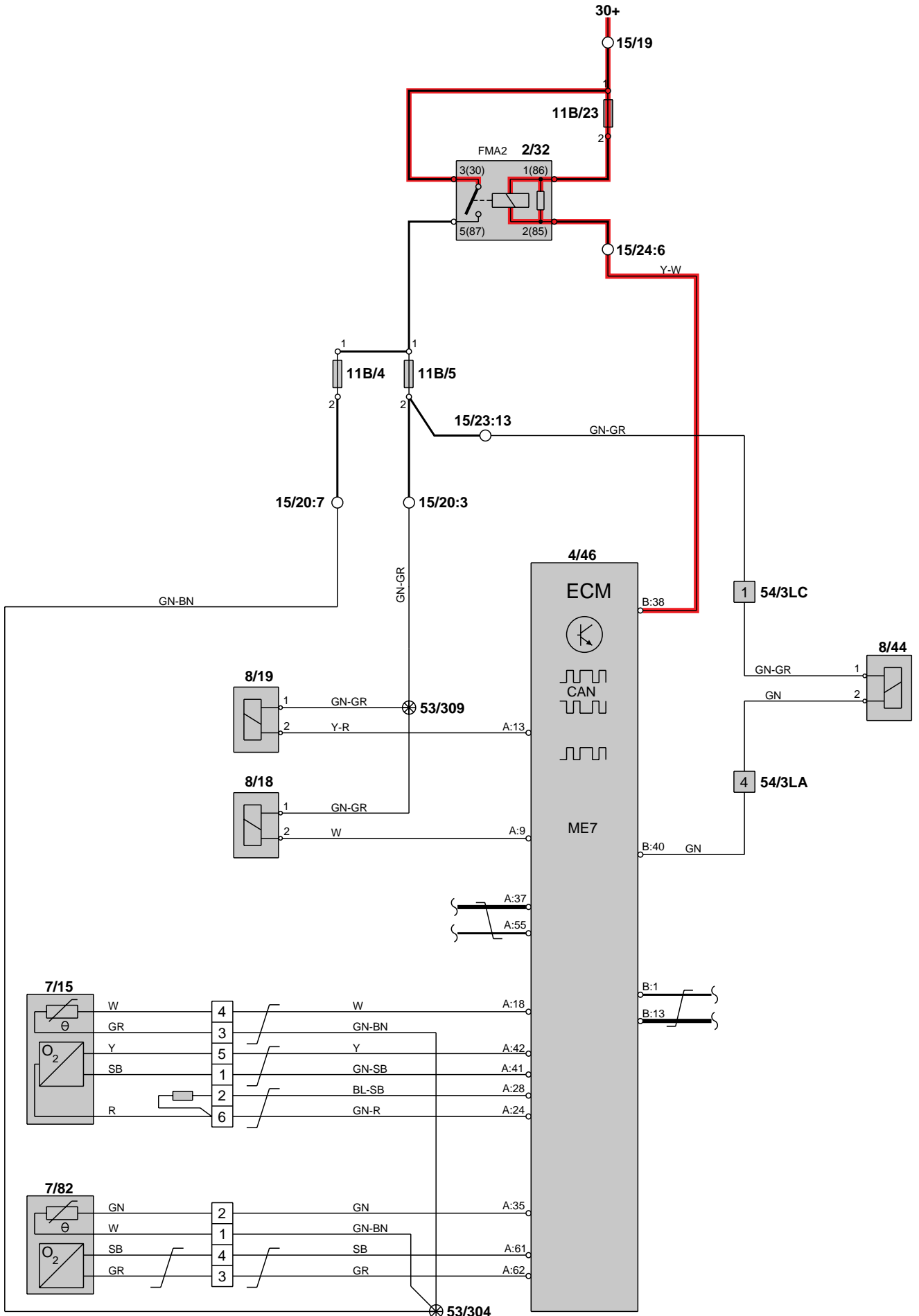

Group 26 Electric cooling fan

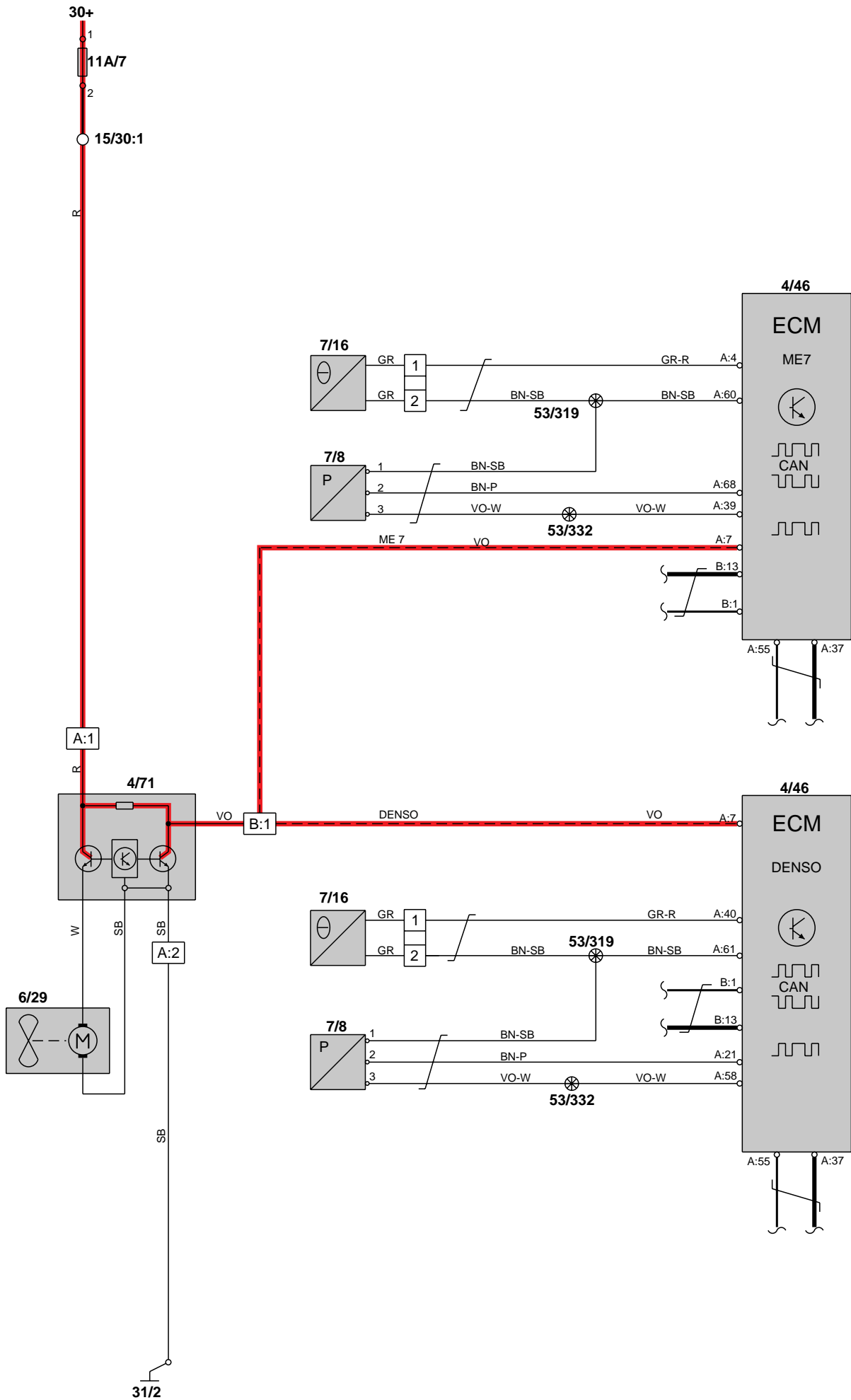

Group 27 Cruise control

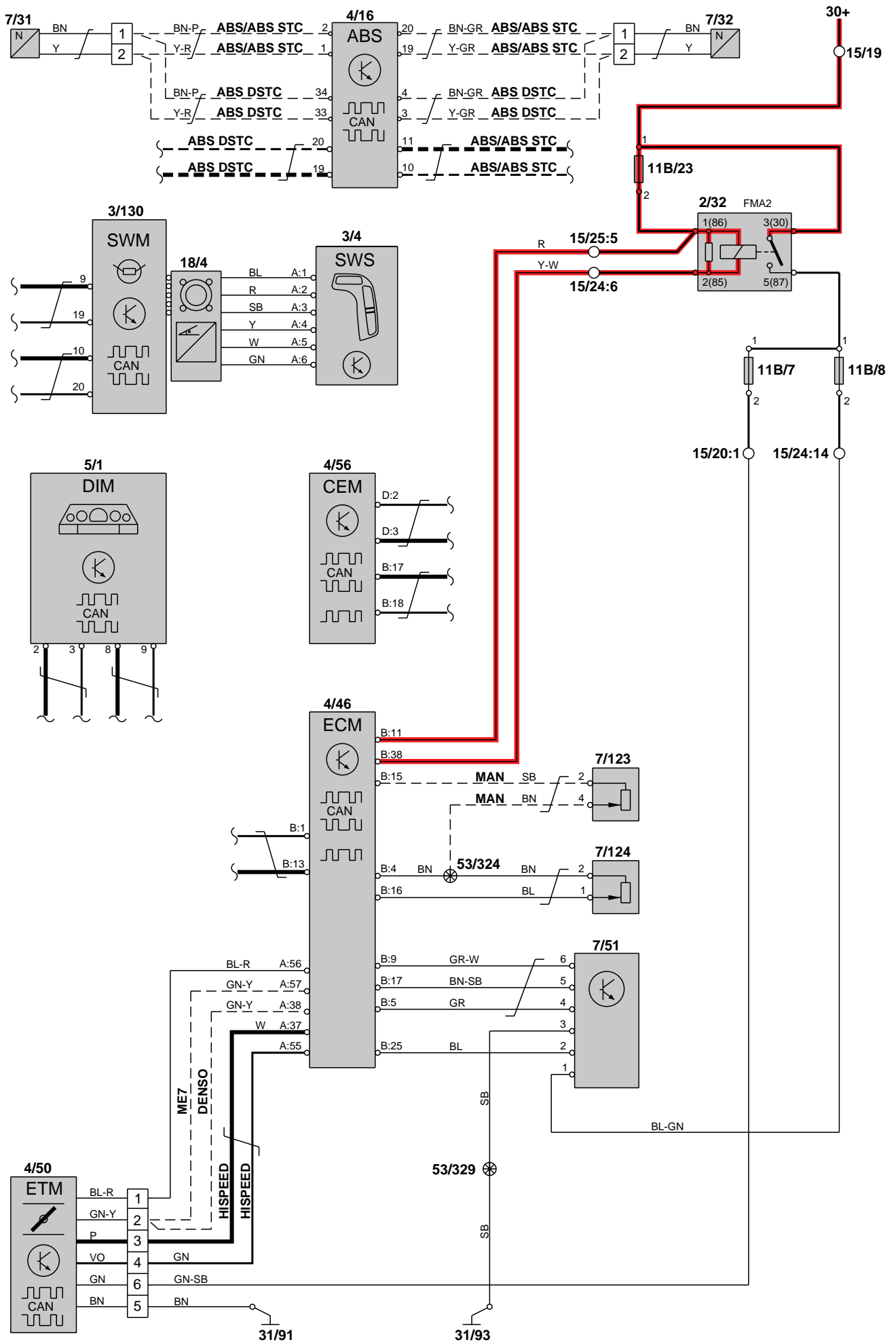

Group 32 Power supply

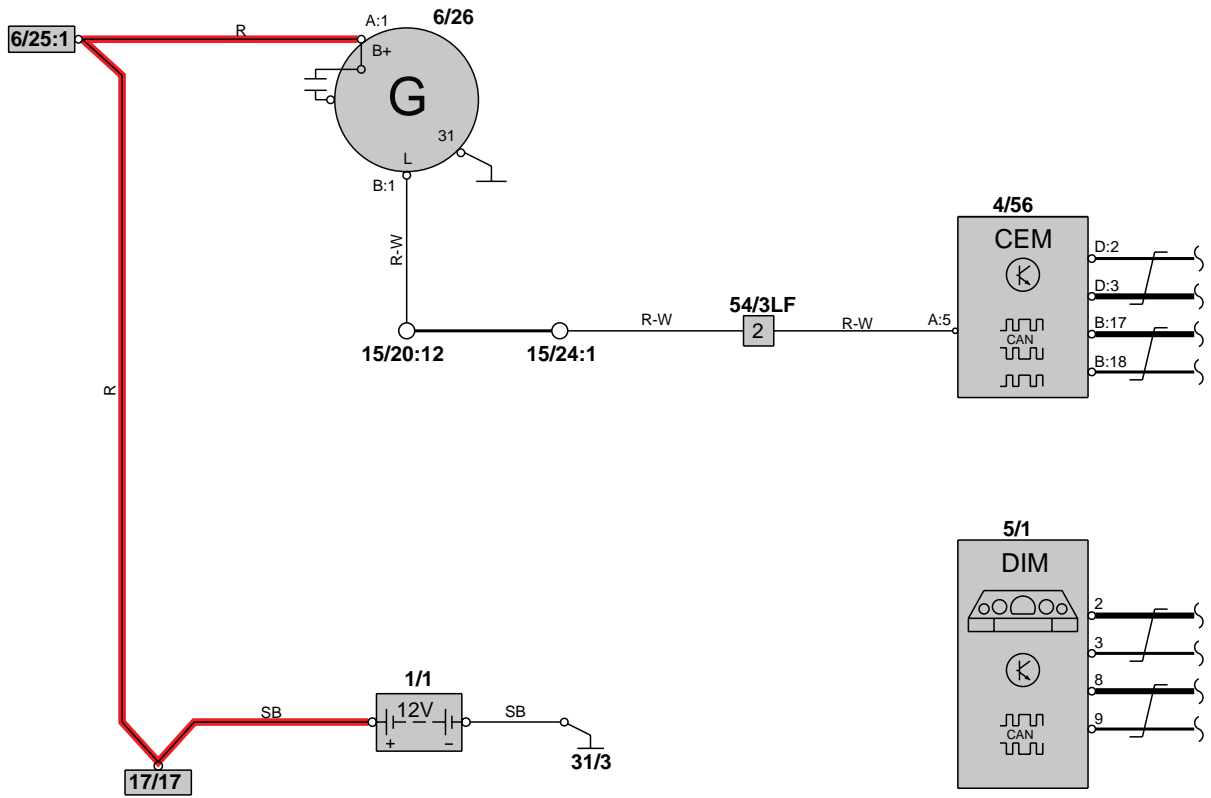

Group 33 Starting system

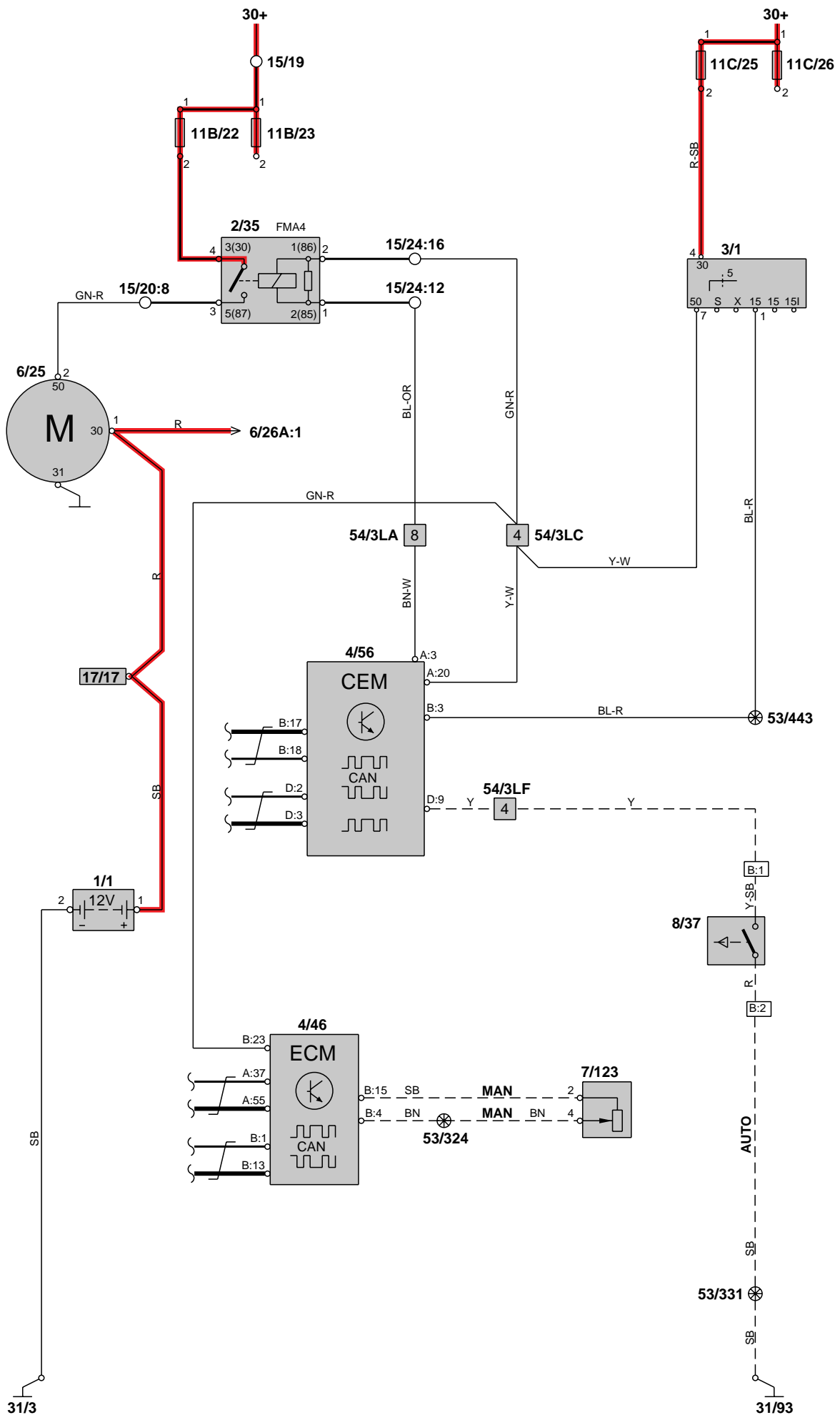

Group 35

High beam, low beam and auxiliary light wiring

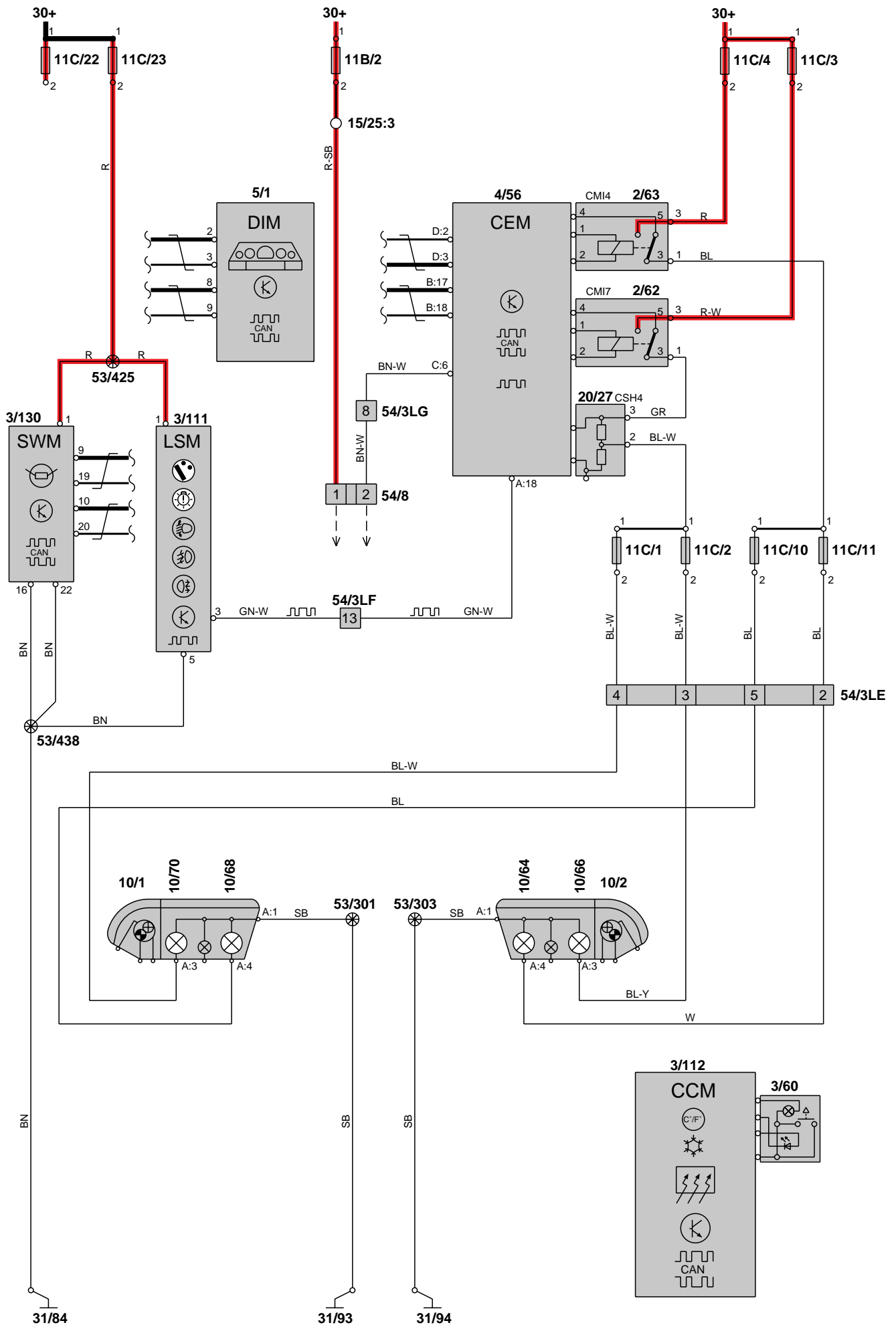

Fog light

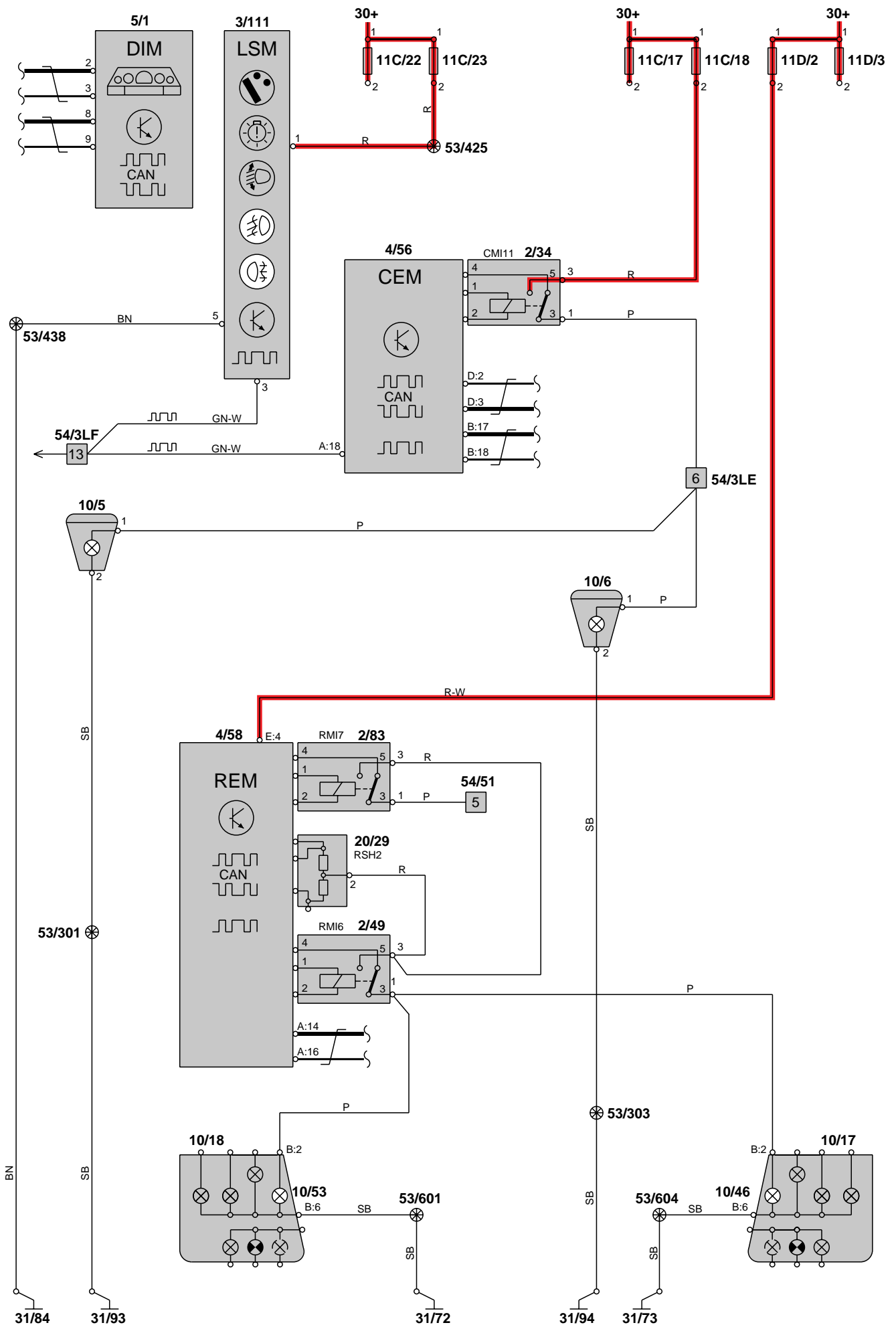

Parking light, tail lights and license plate lighting

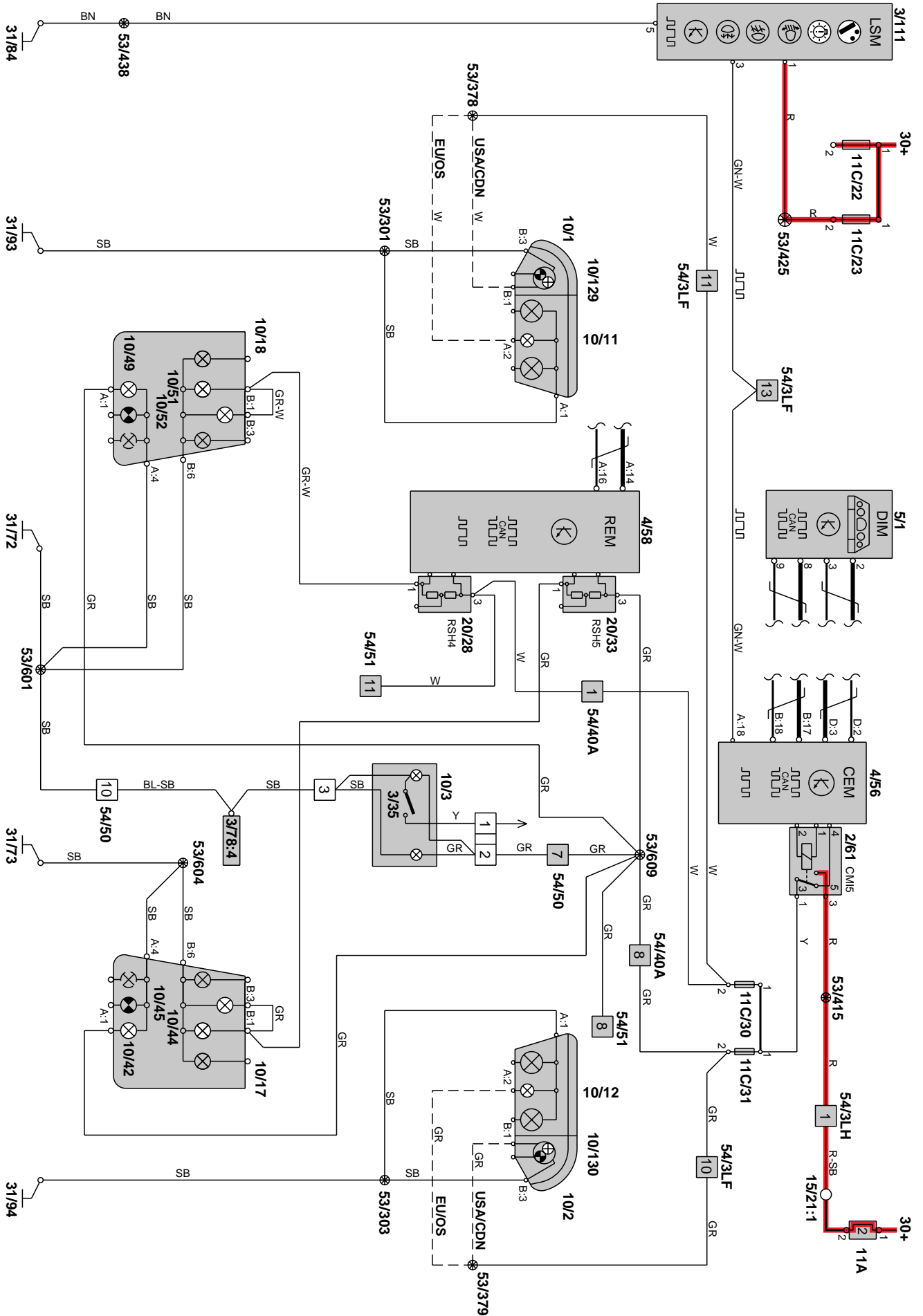

Brake lights

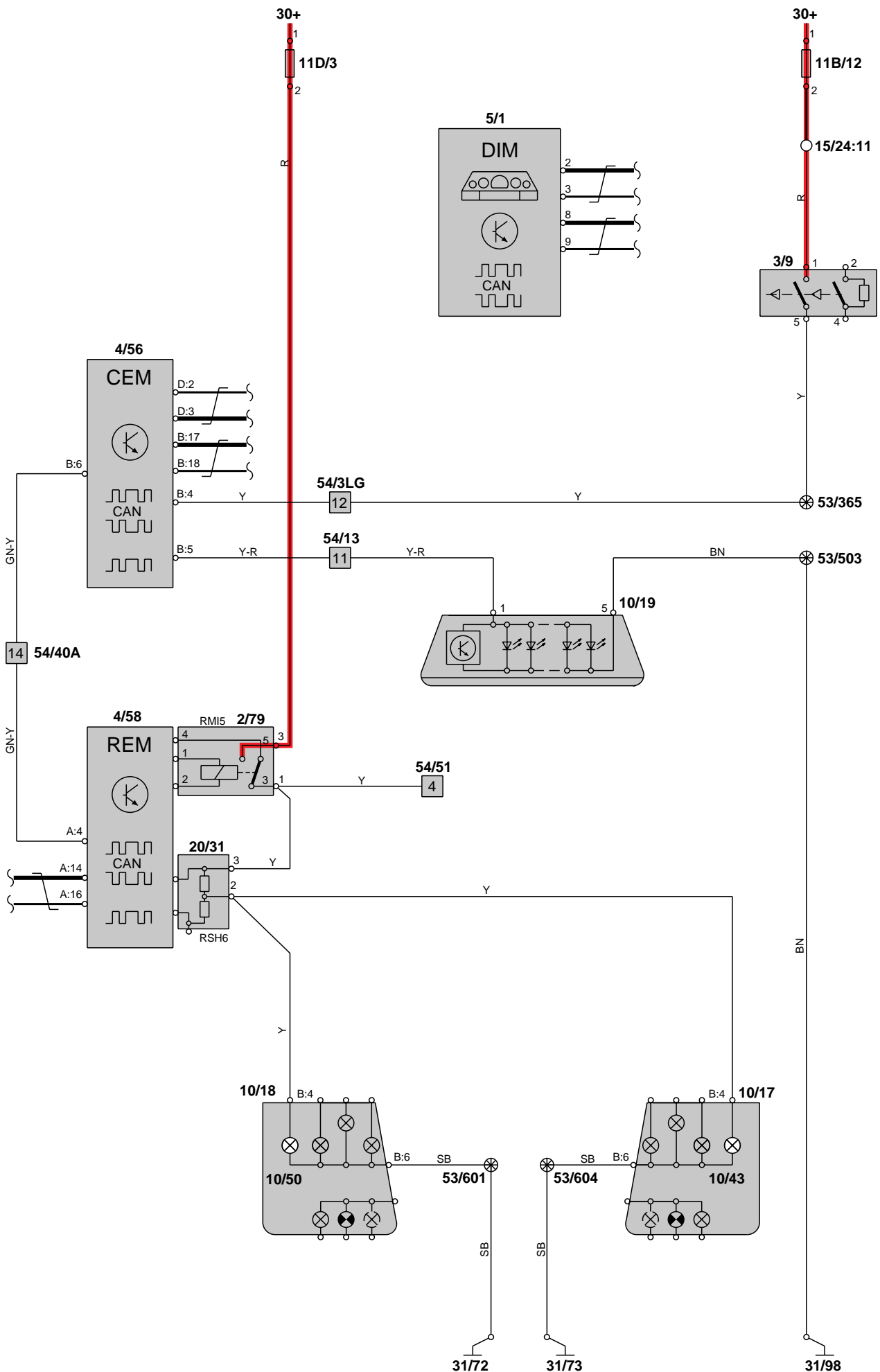

Group 36

Indicators and warning lights

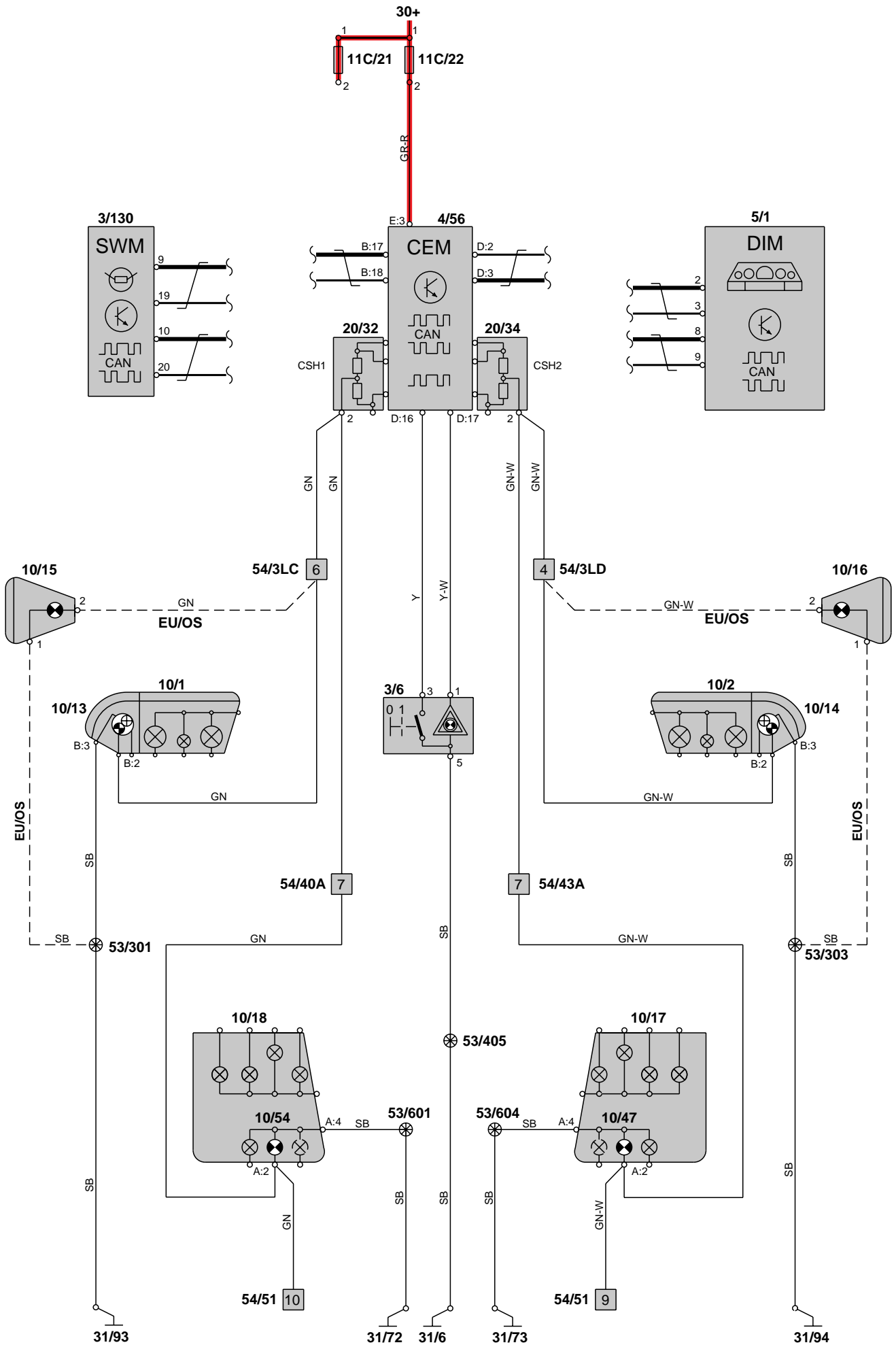

Beam length adjustment

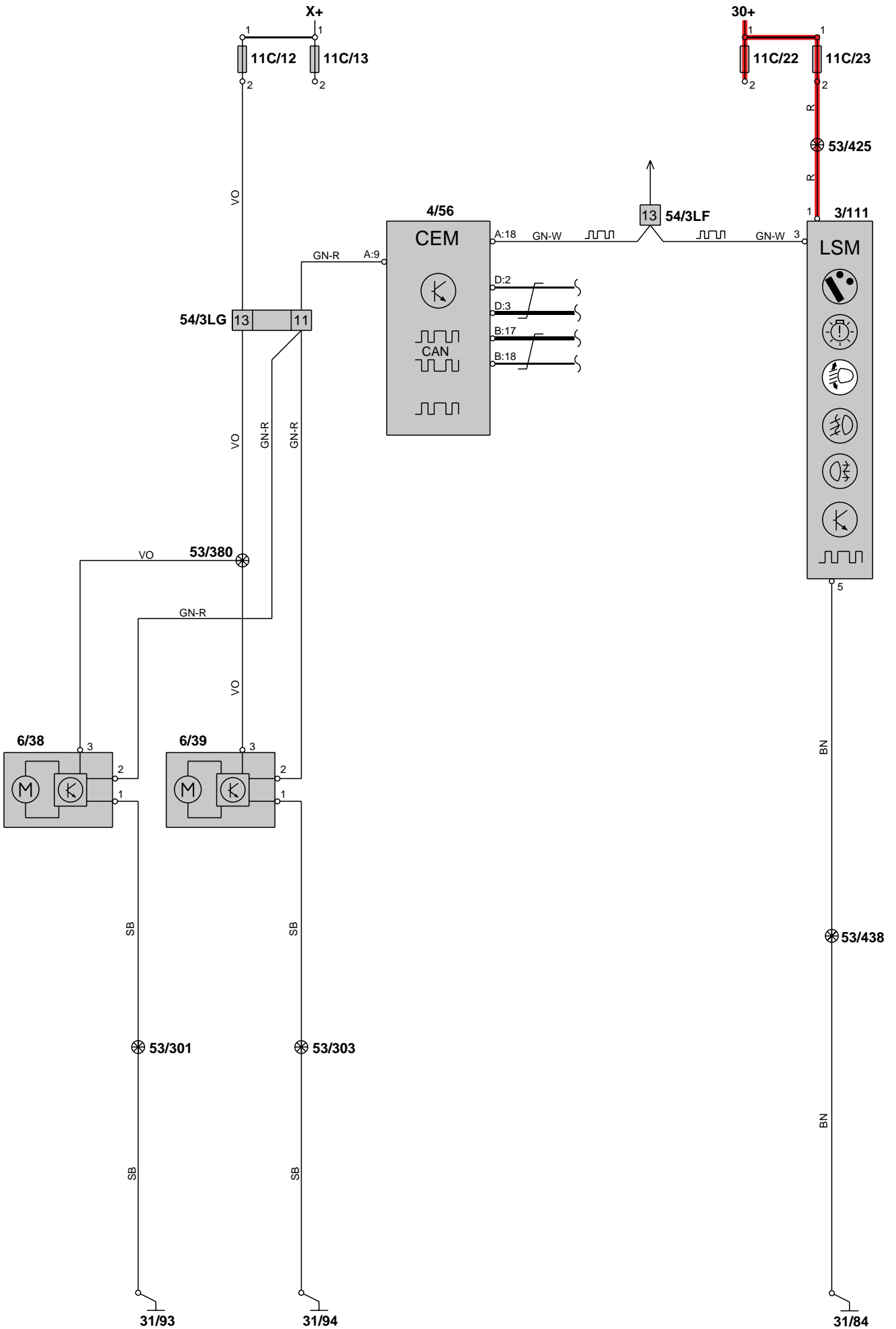

Instrument and control lighting

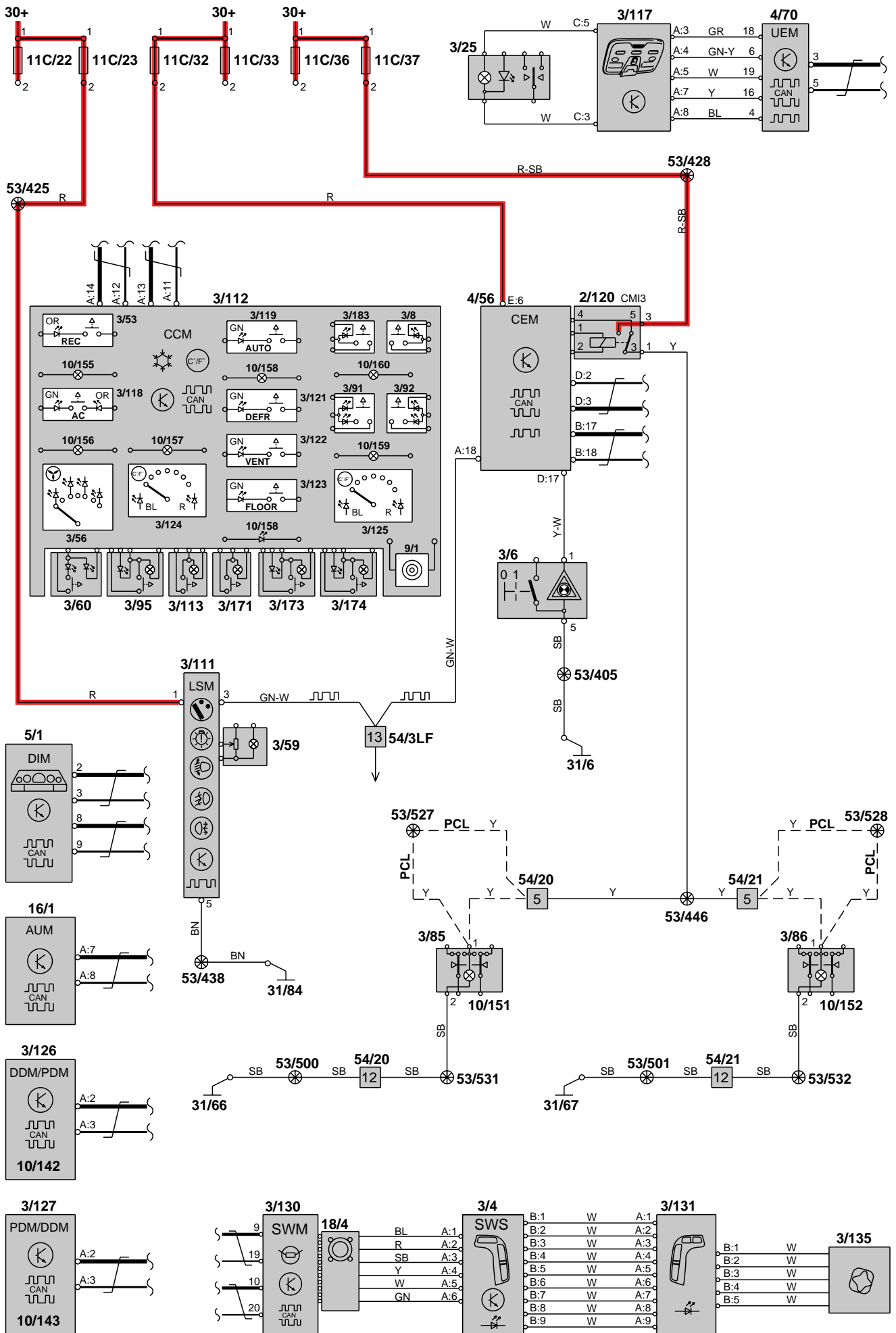

Safety lighting

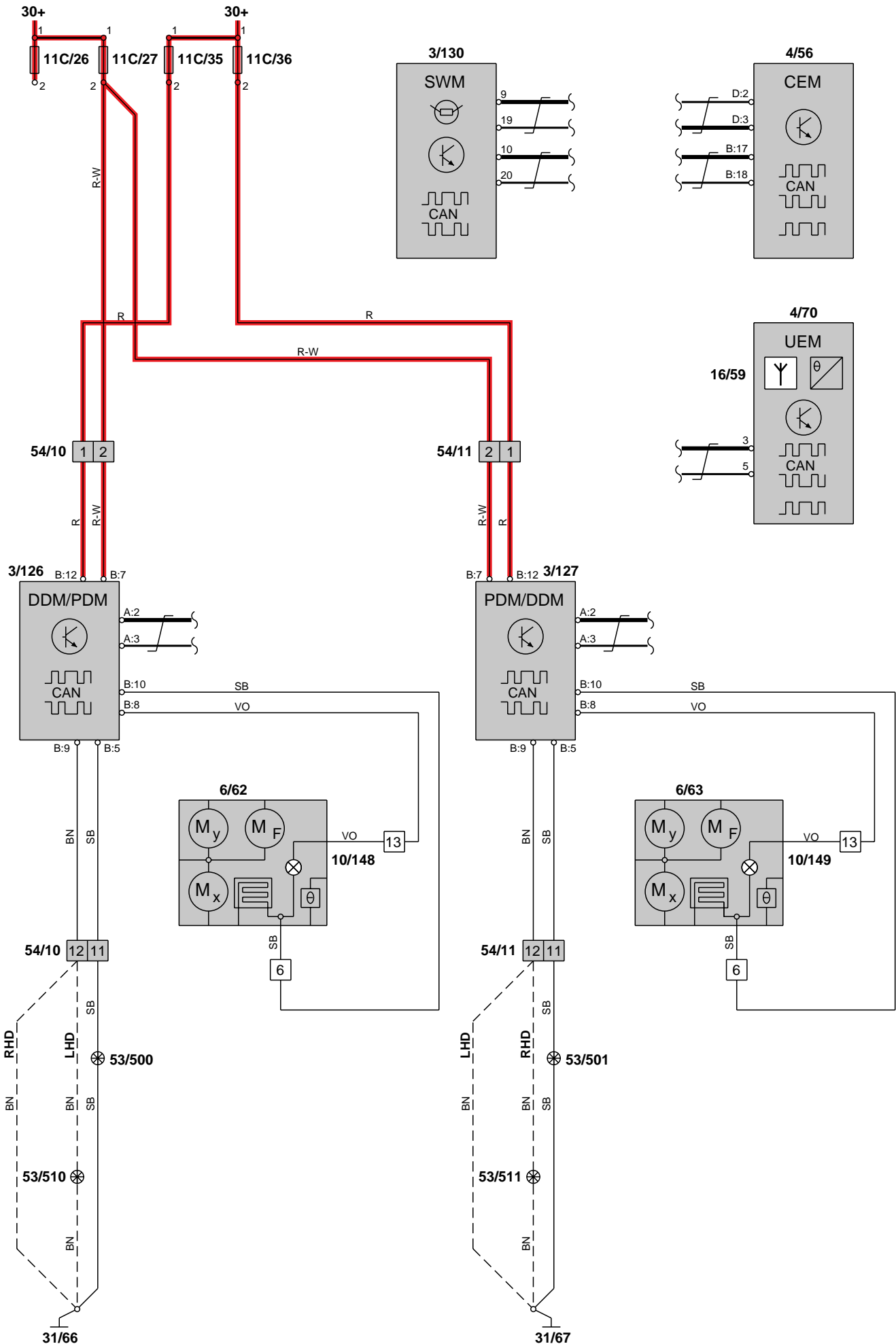

Horn

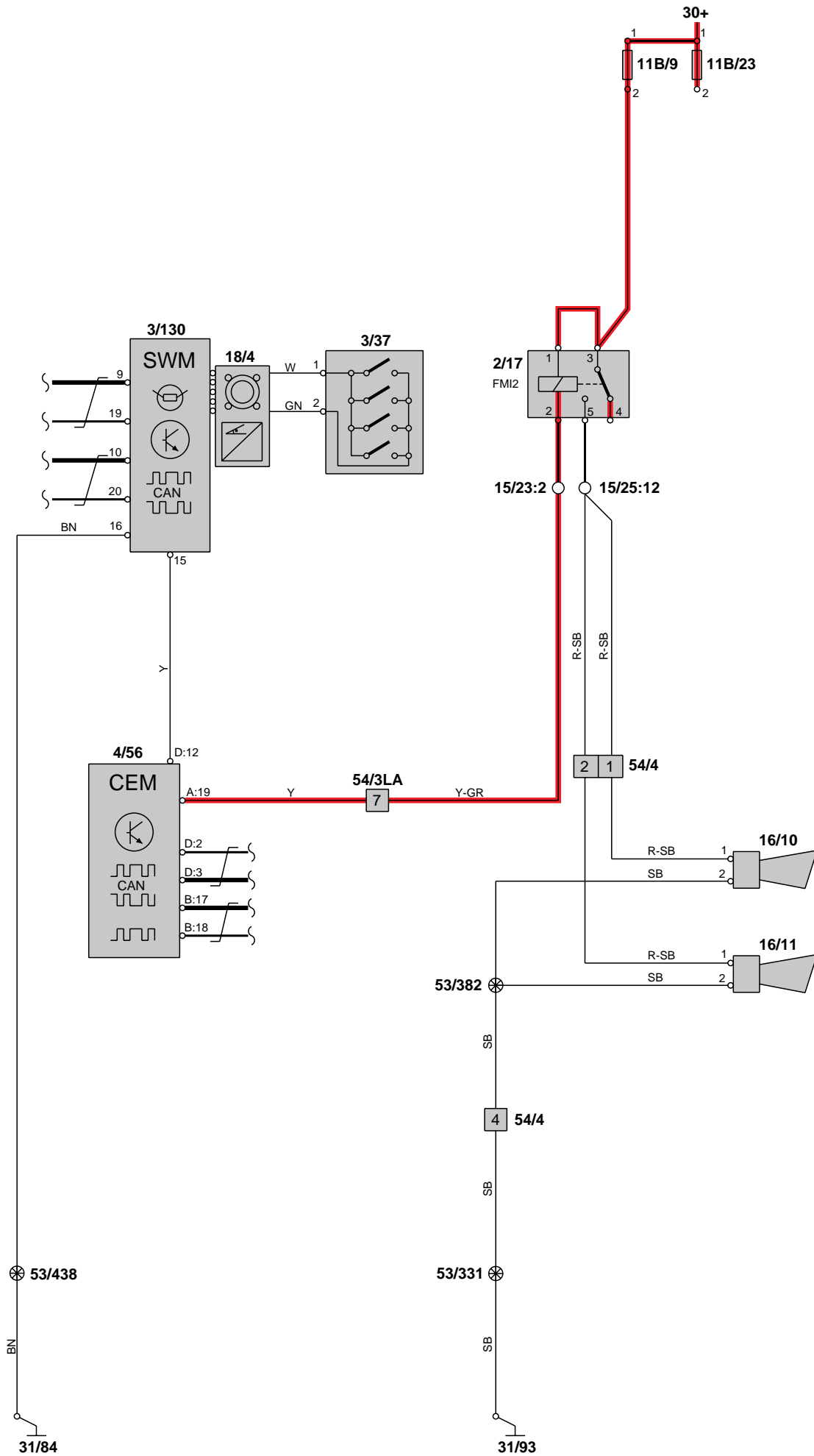

Wiper/Washer, Windshield

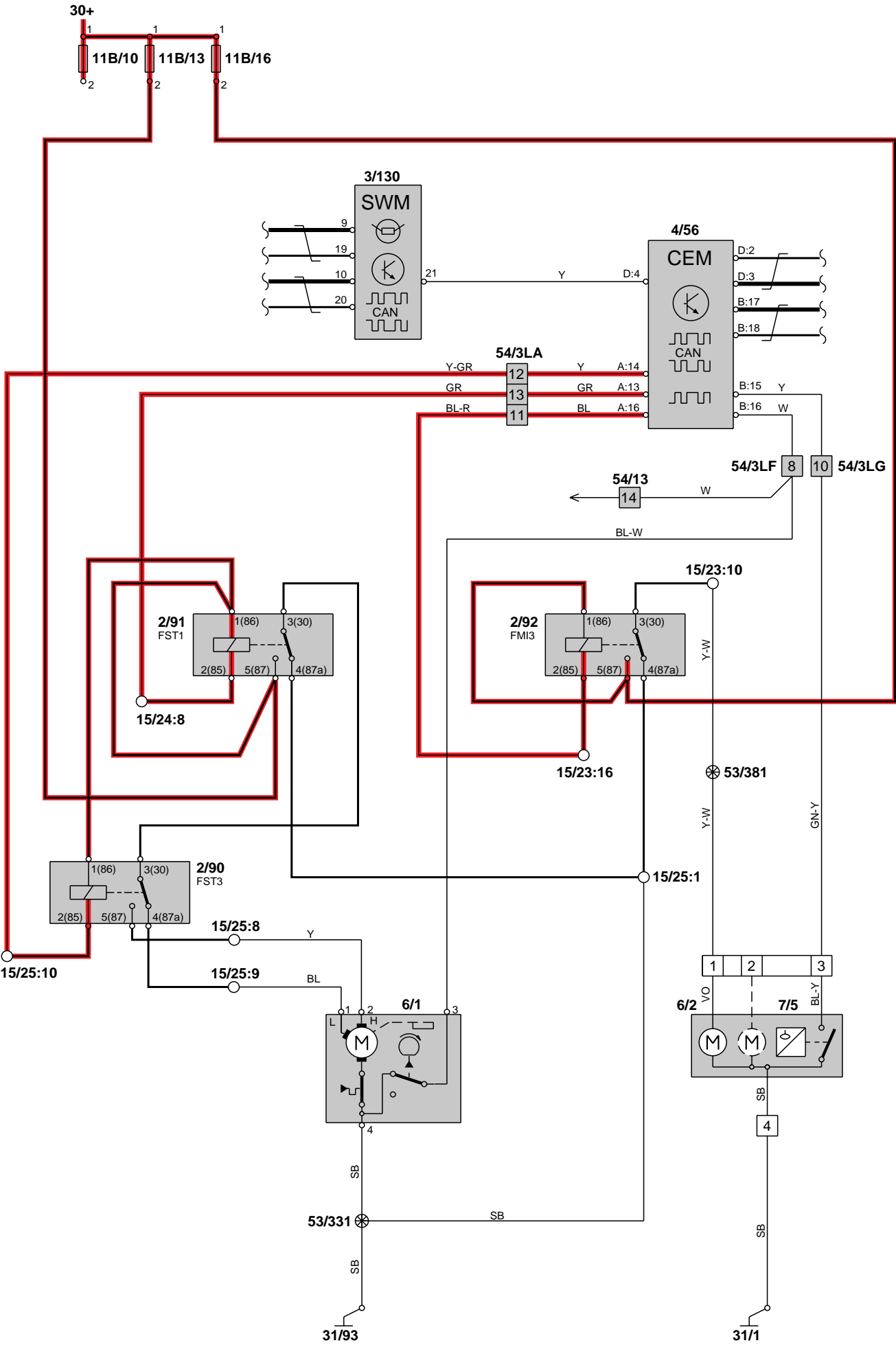

Wiper/Washer, Headlights

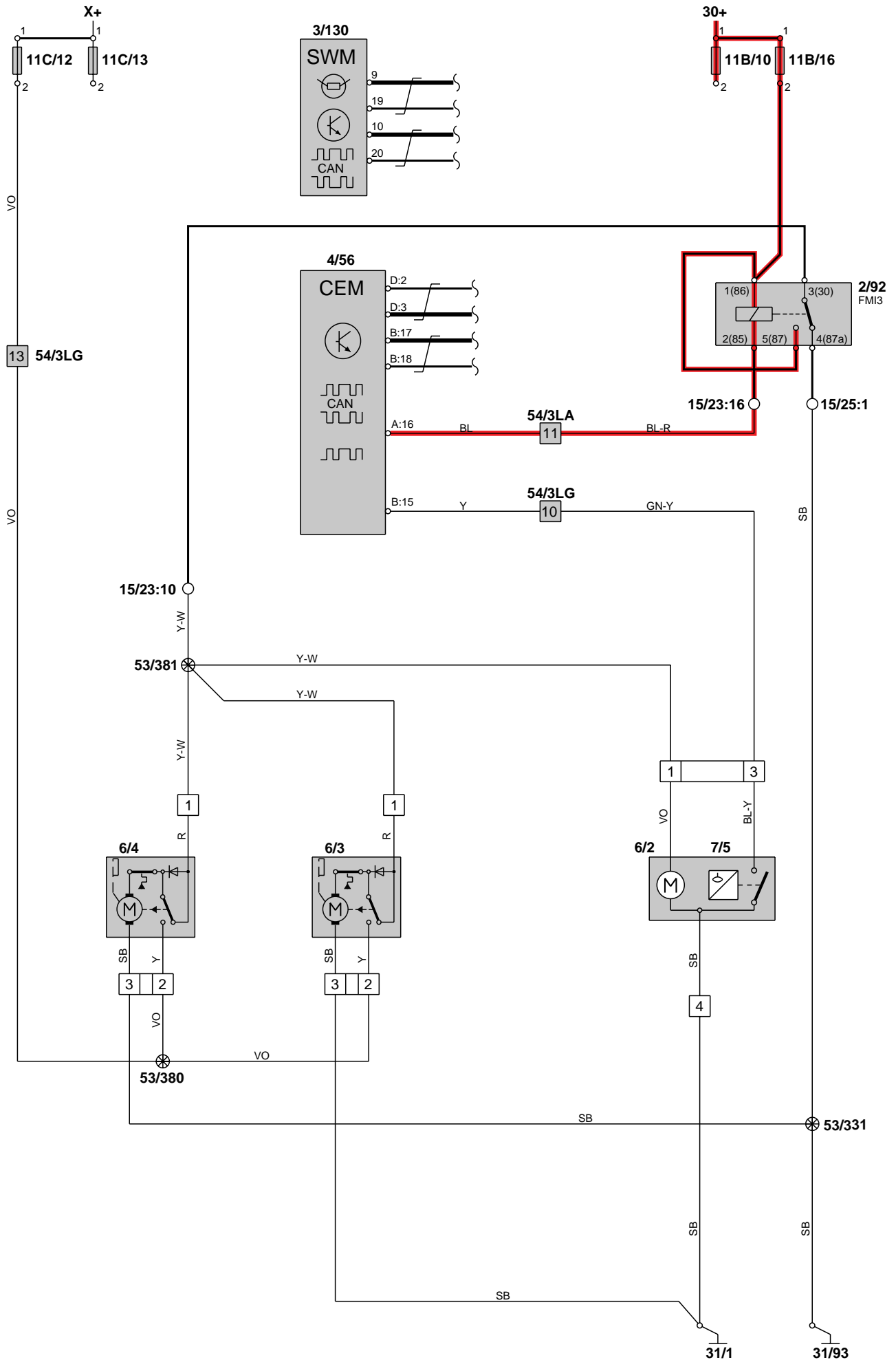

Cigarette lighter

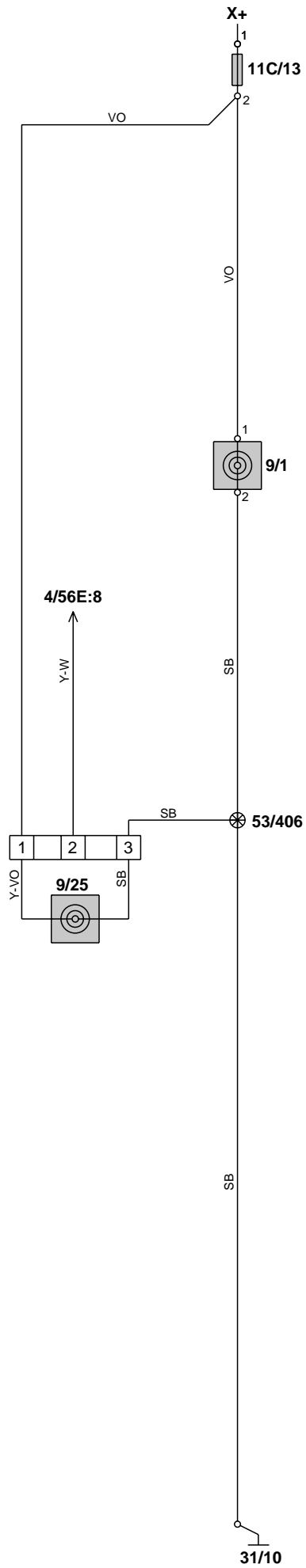

Electronic immobilizer

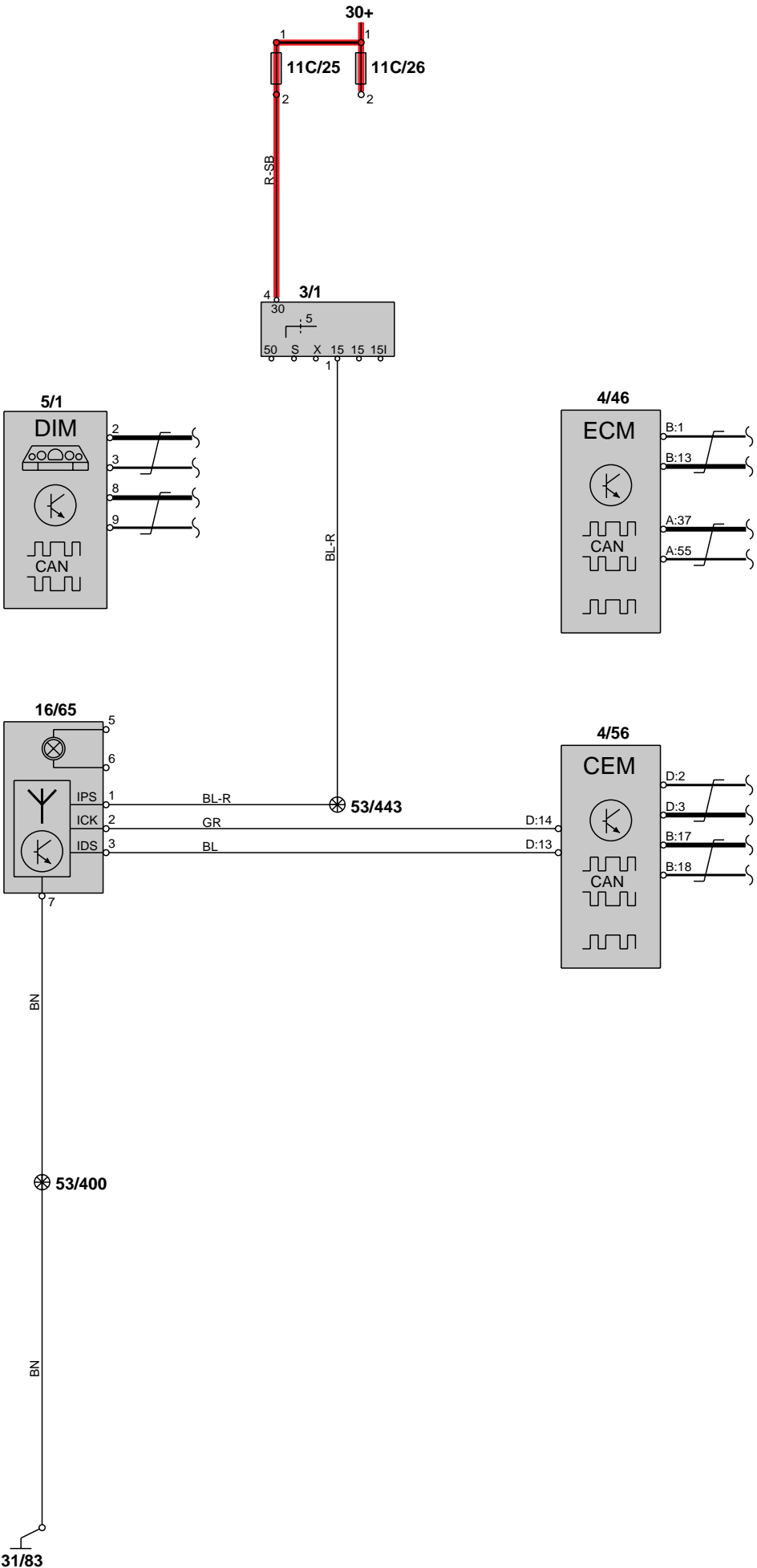

Anti-theft alarm

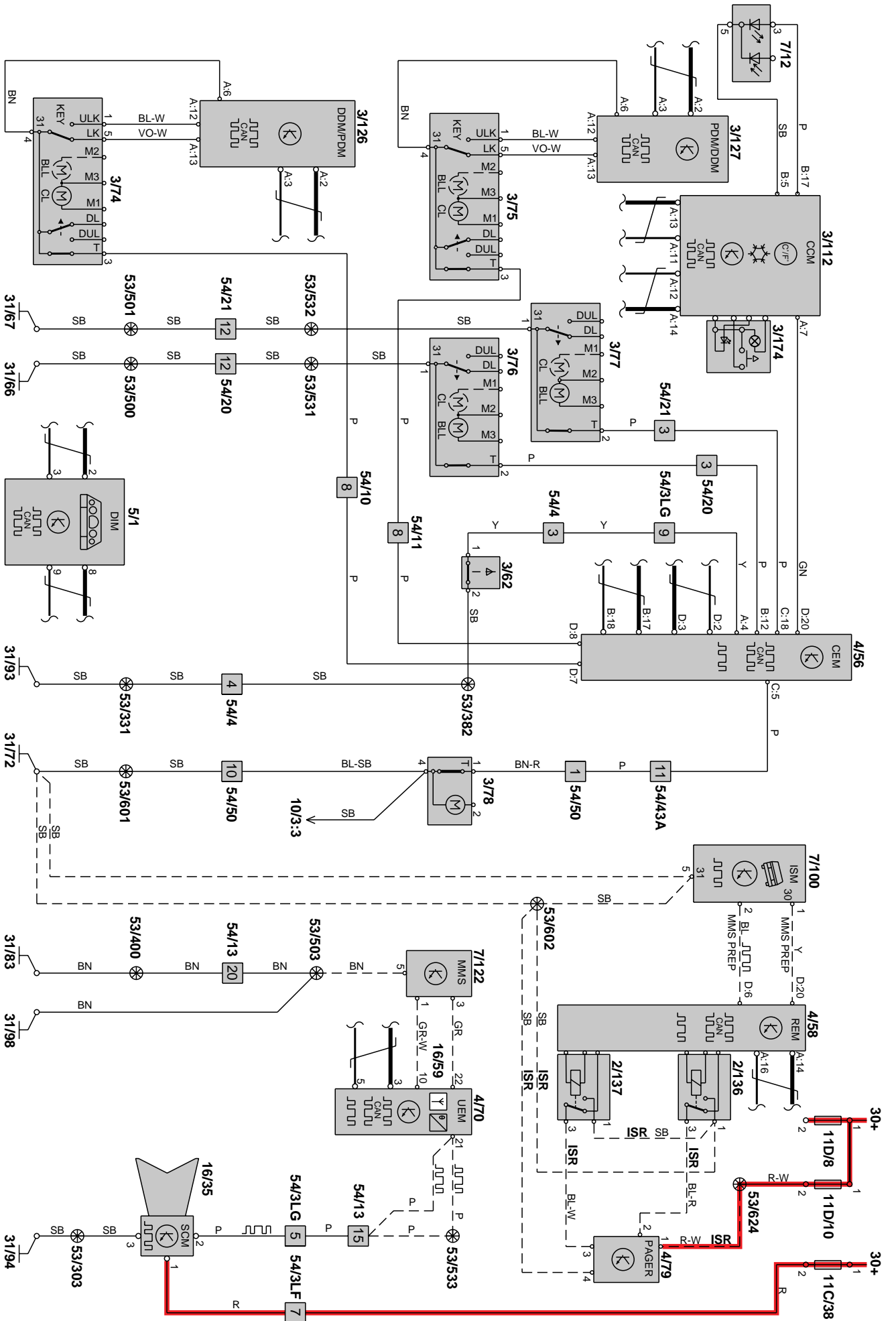

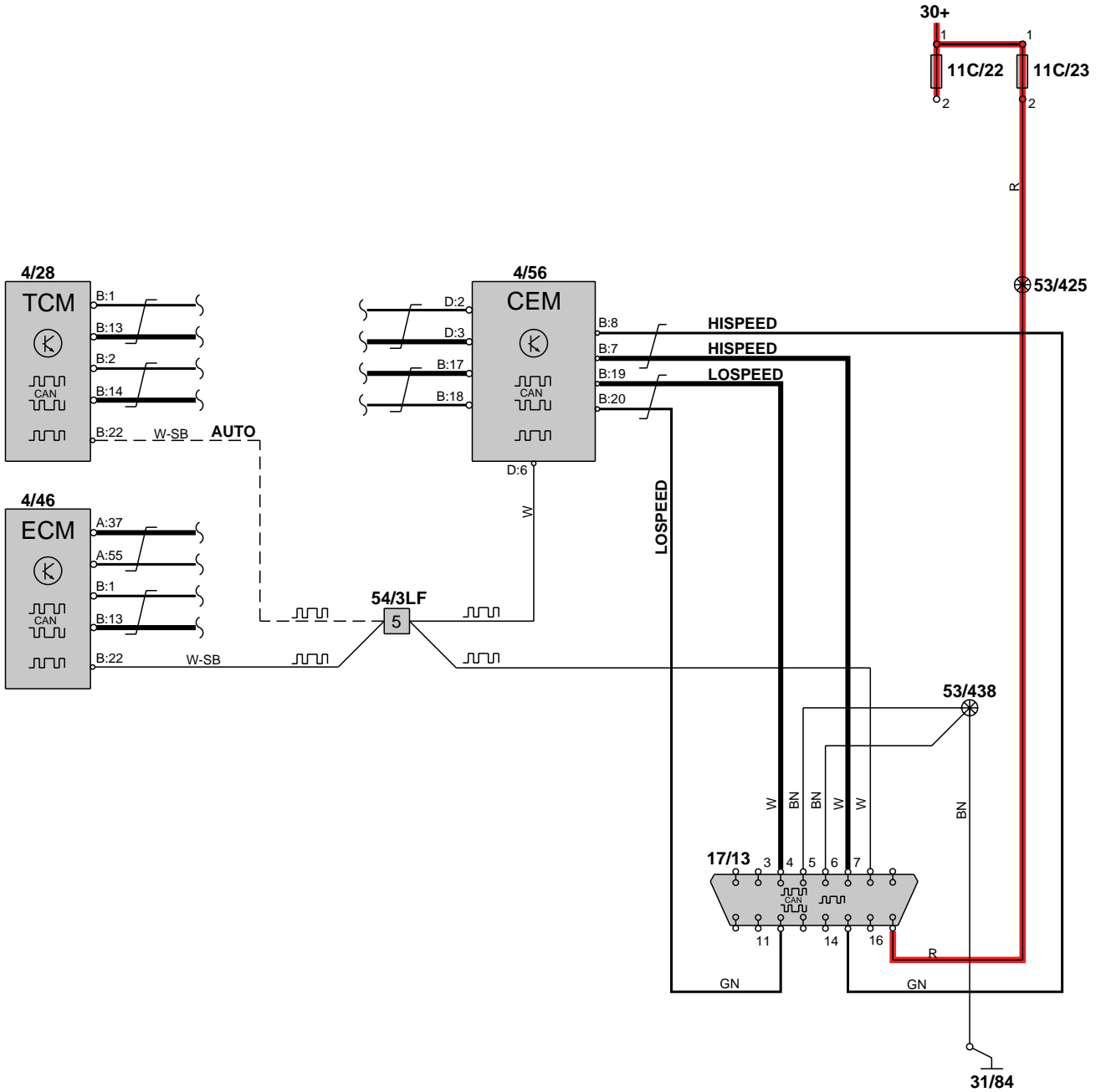

Towing bracket wiring

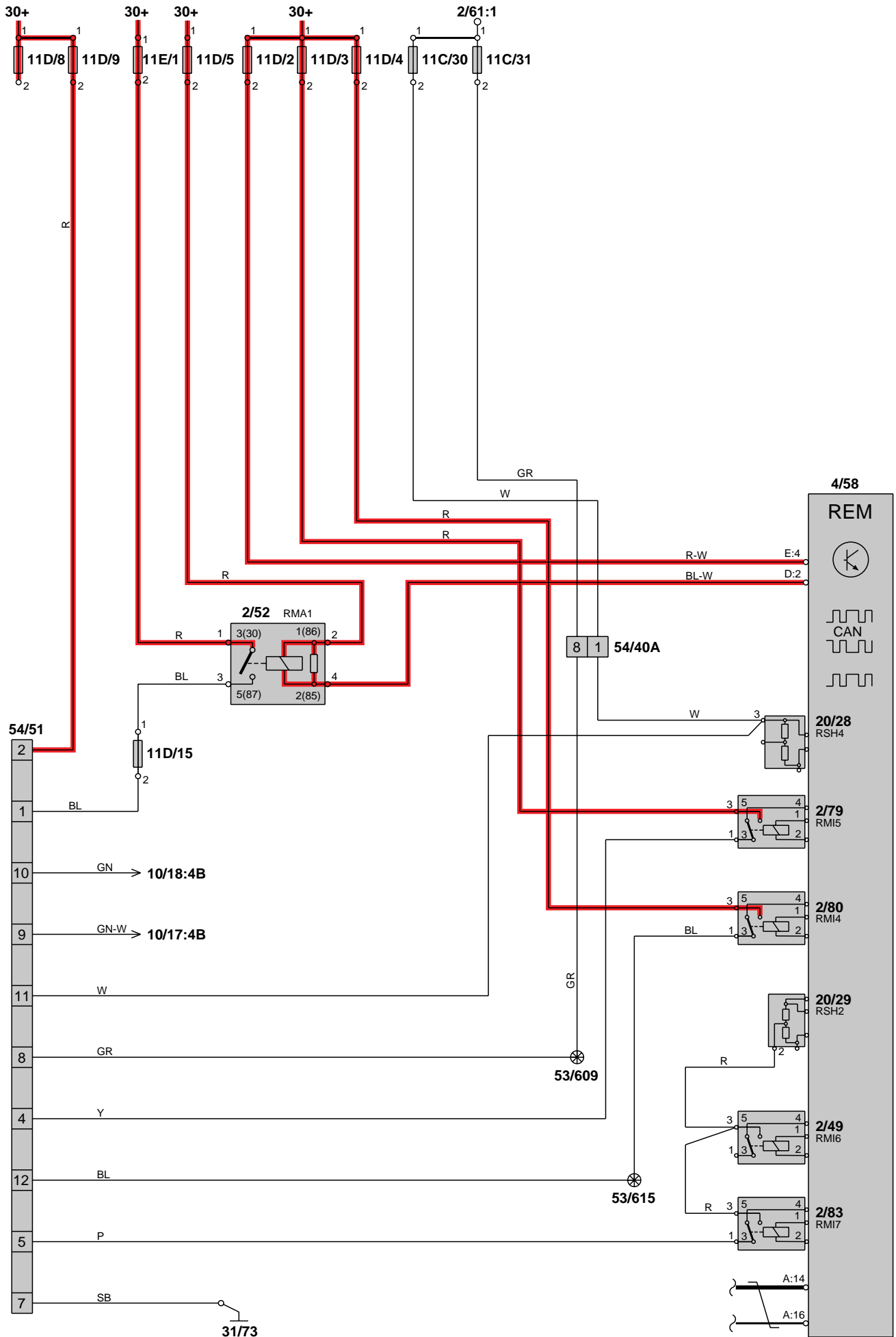

Auxiliary heater Parking heater

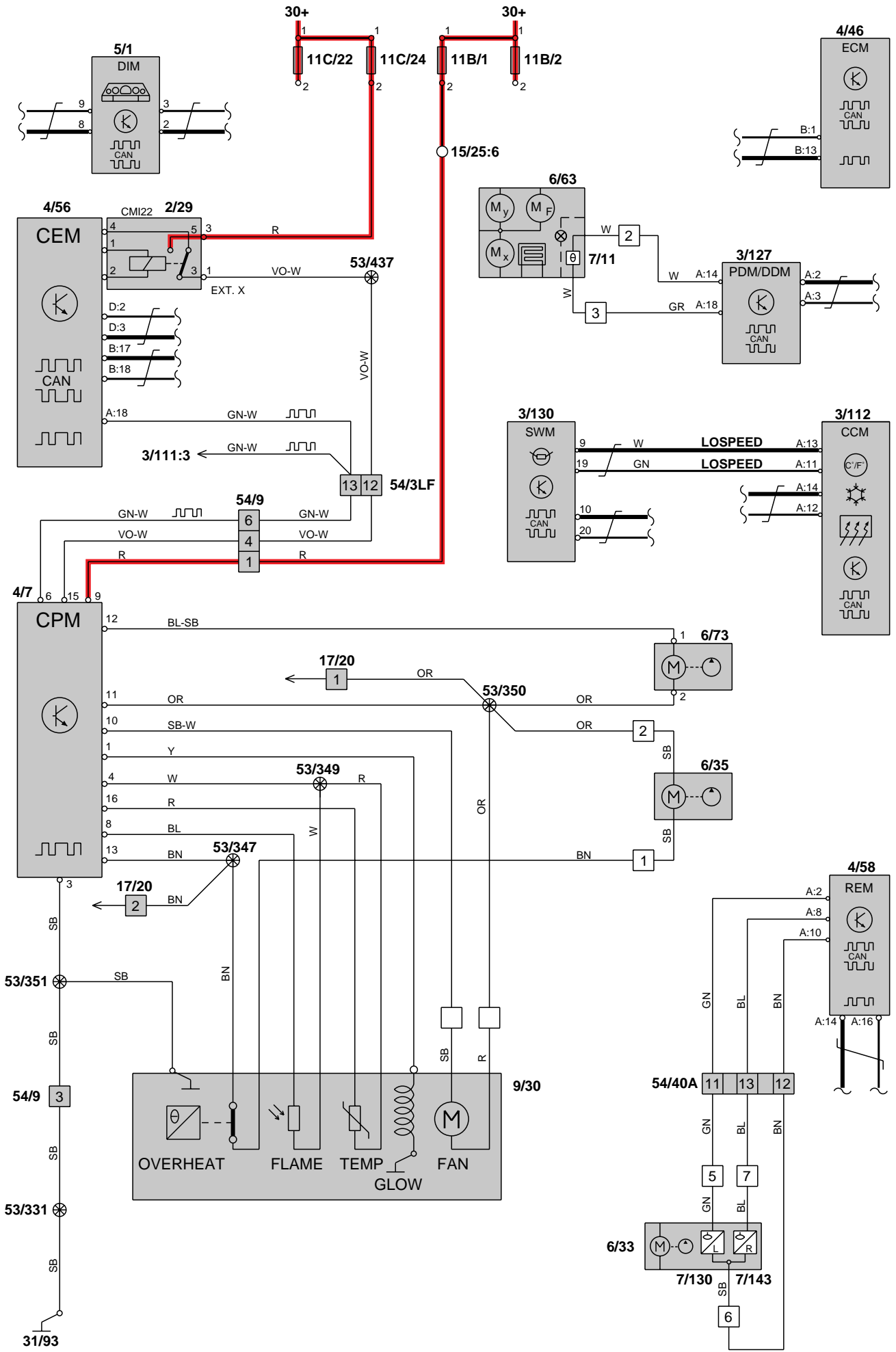

Auxiliary heater Parking heater

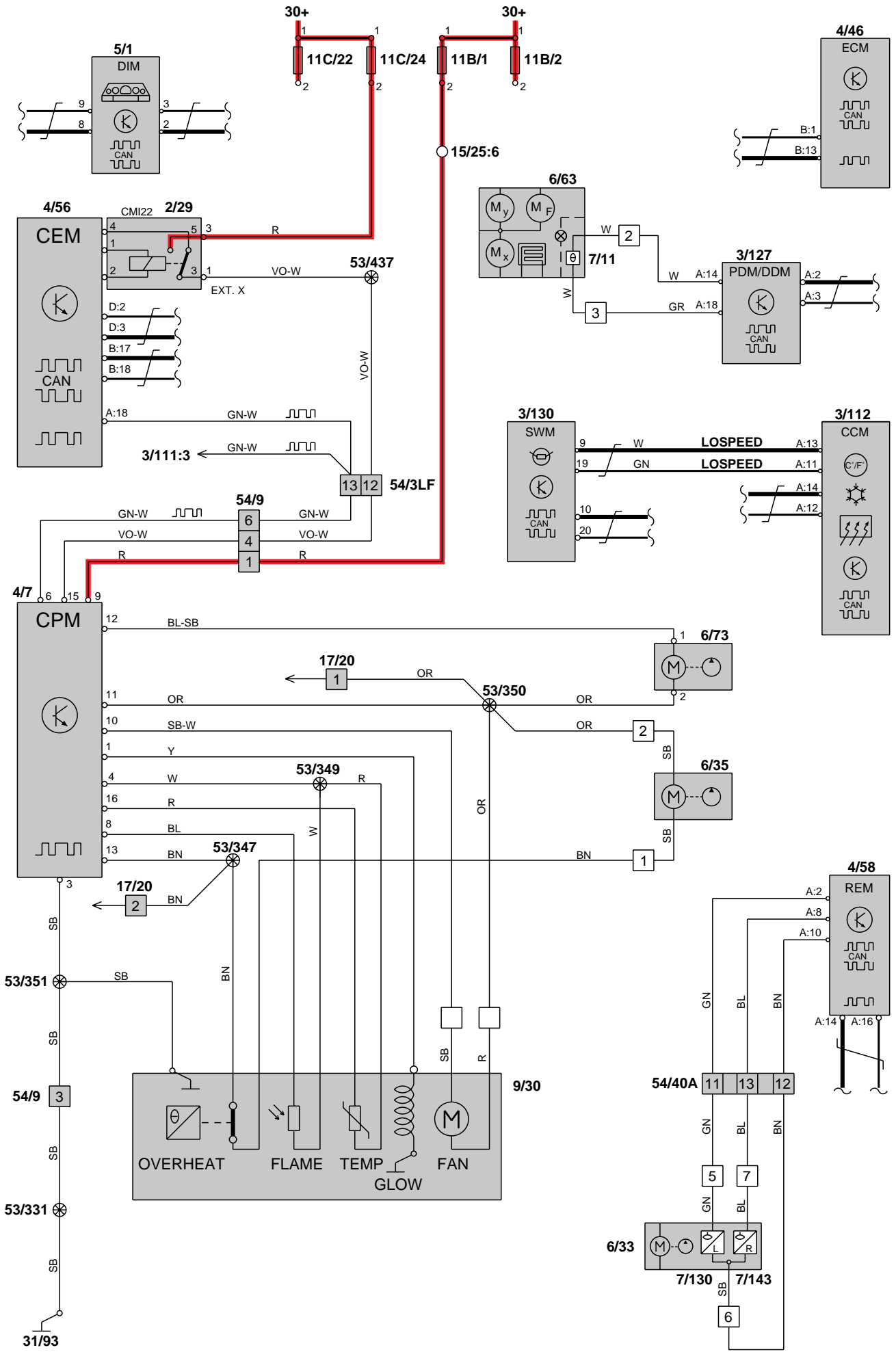

12V outlet, cargo compartment

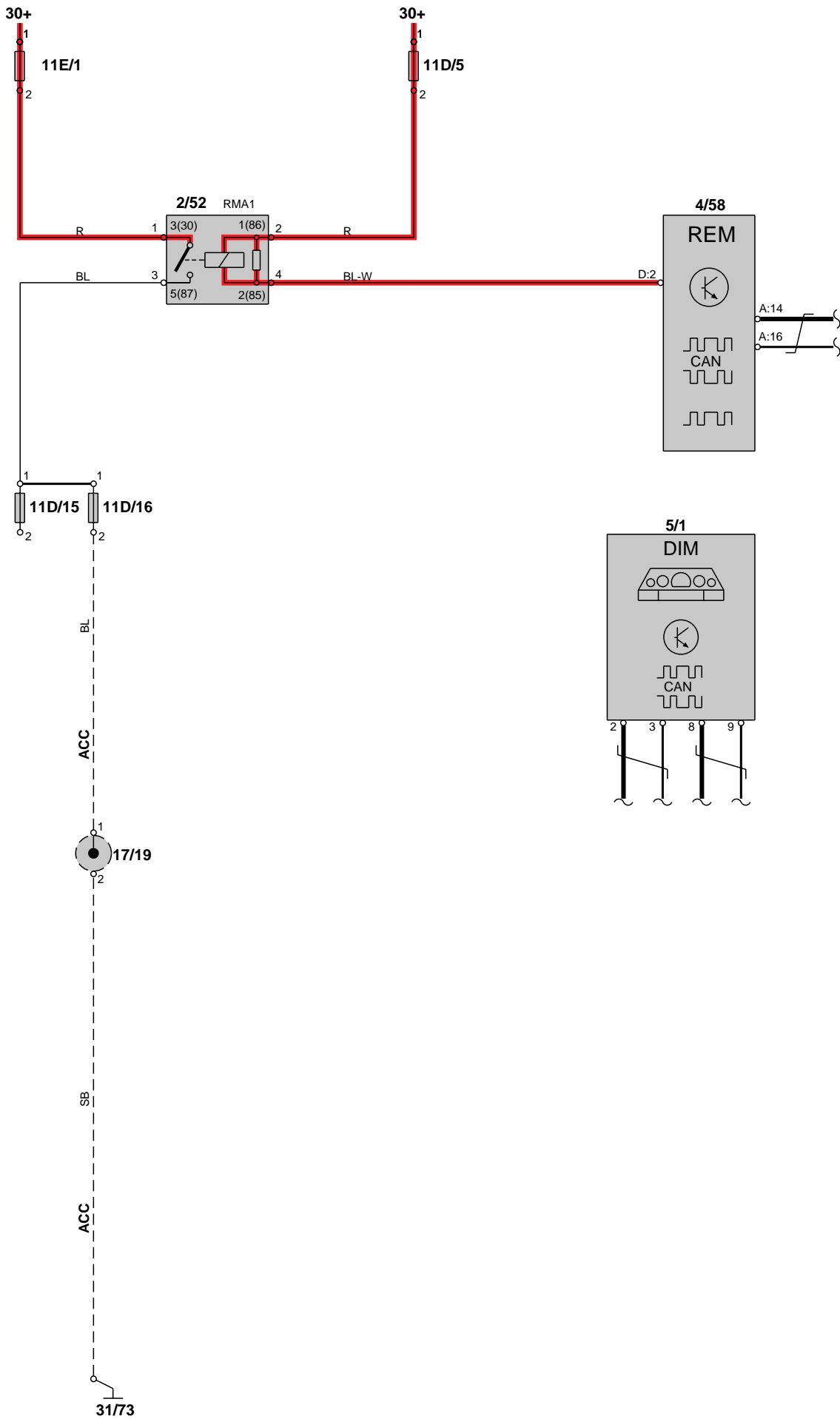

Seat belt reminder

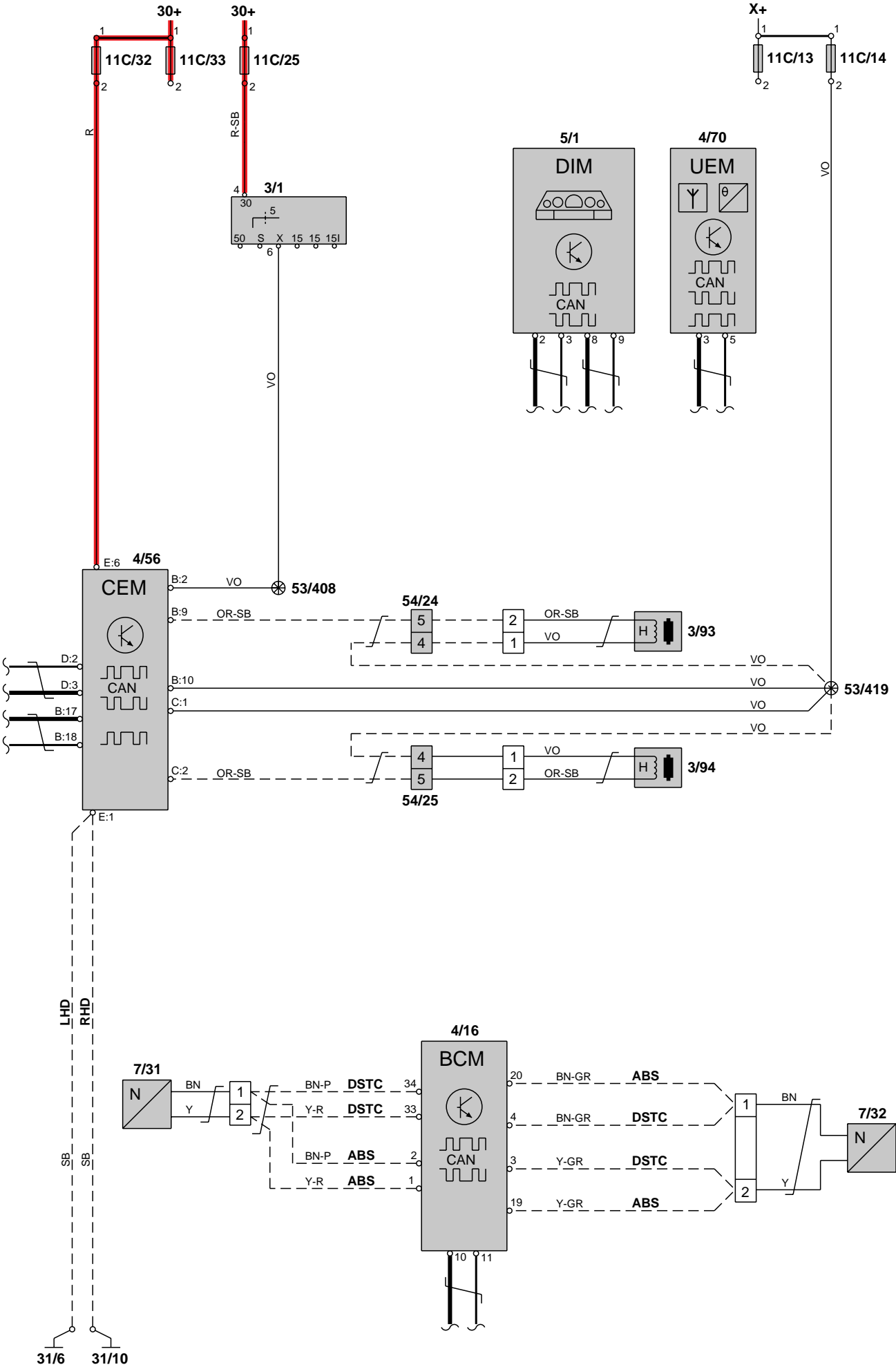

Radio without extra amplifier

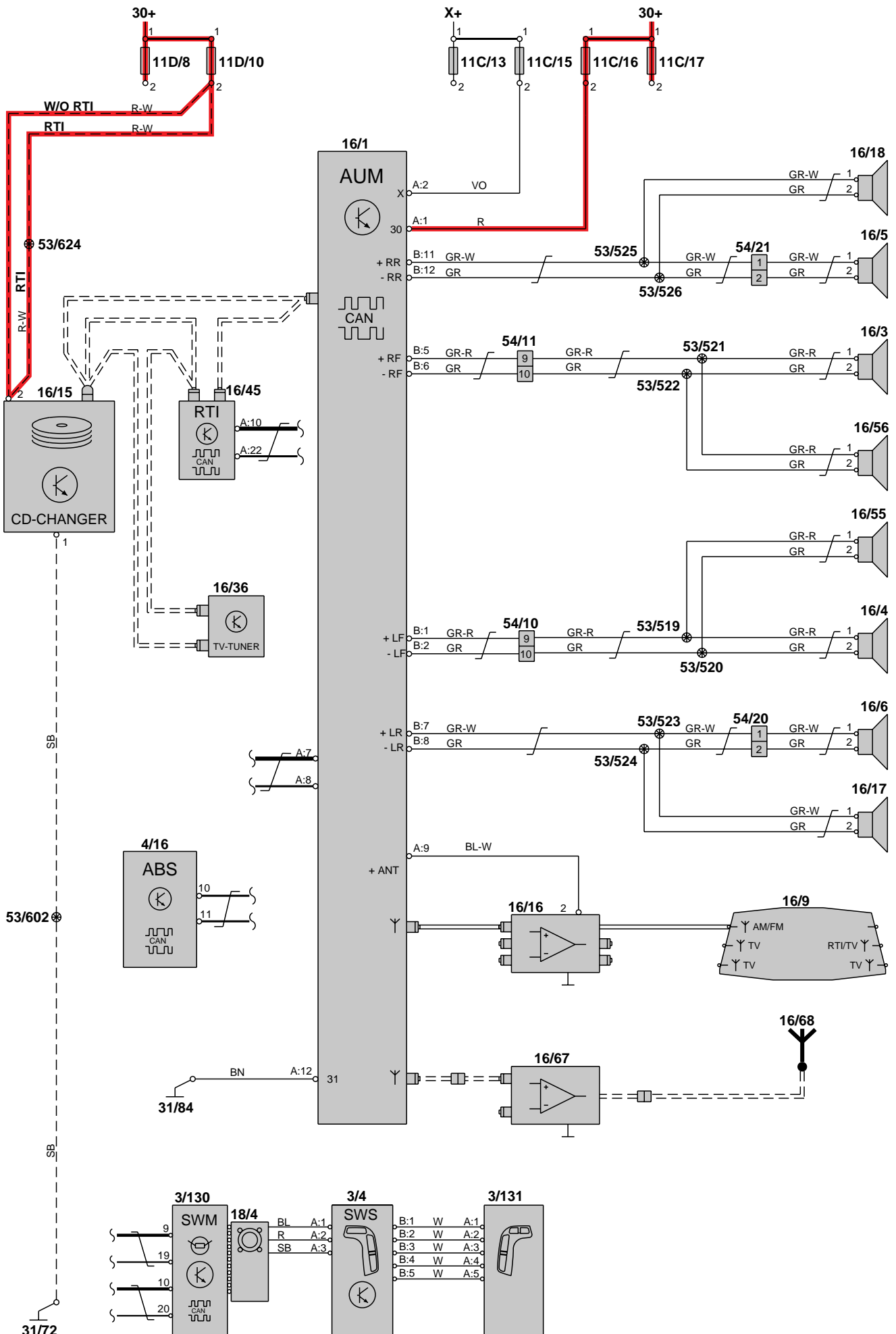

Radio with extra amplifier

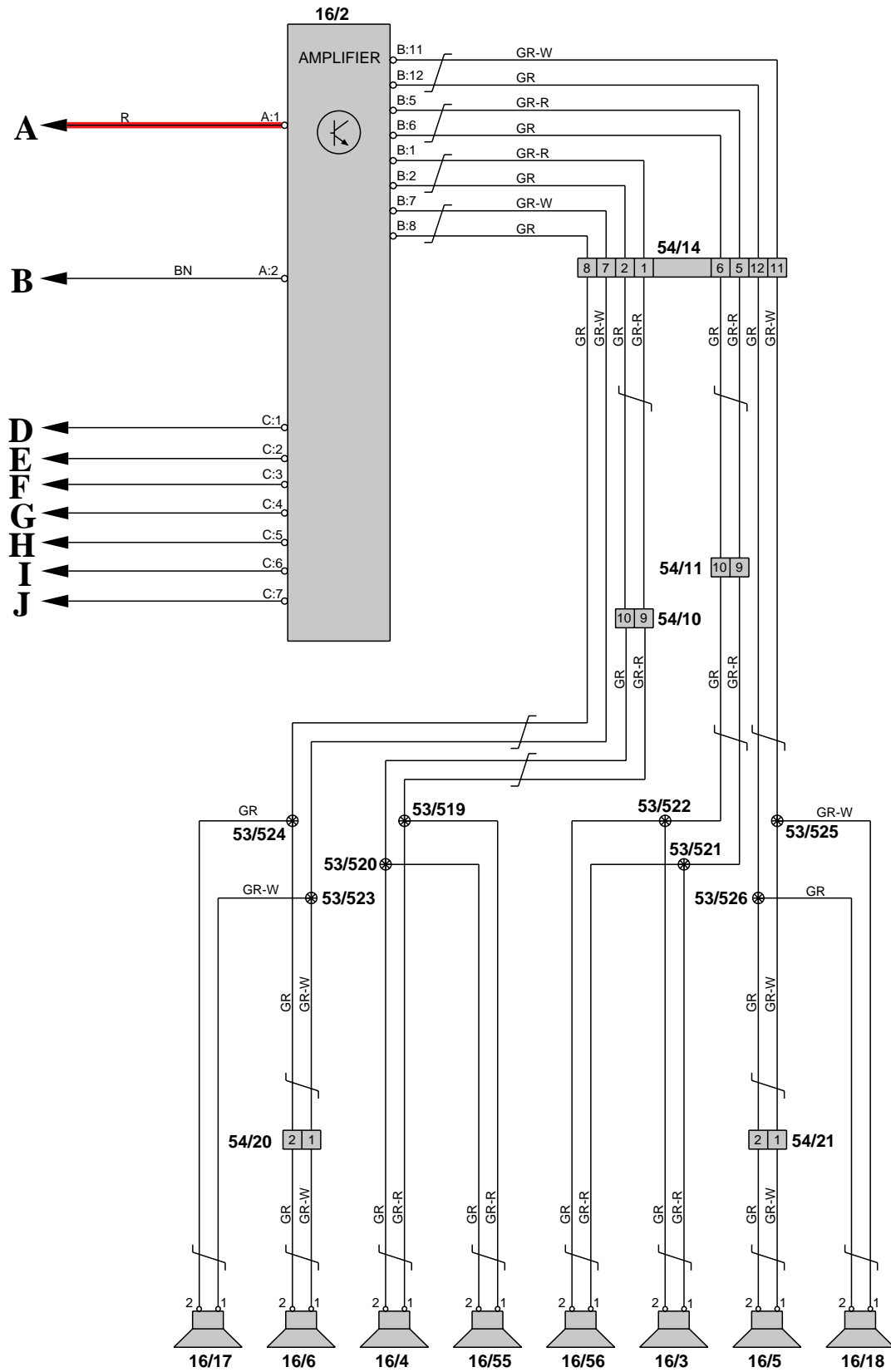

Road Traffic Information RTI

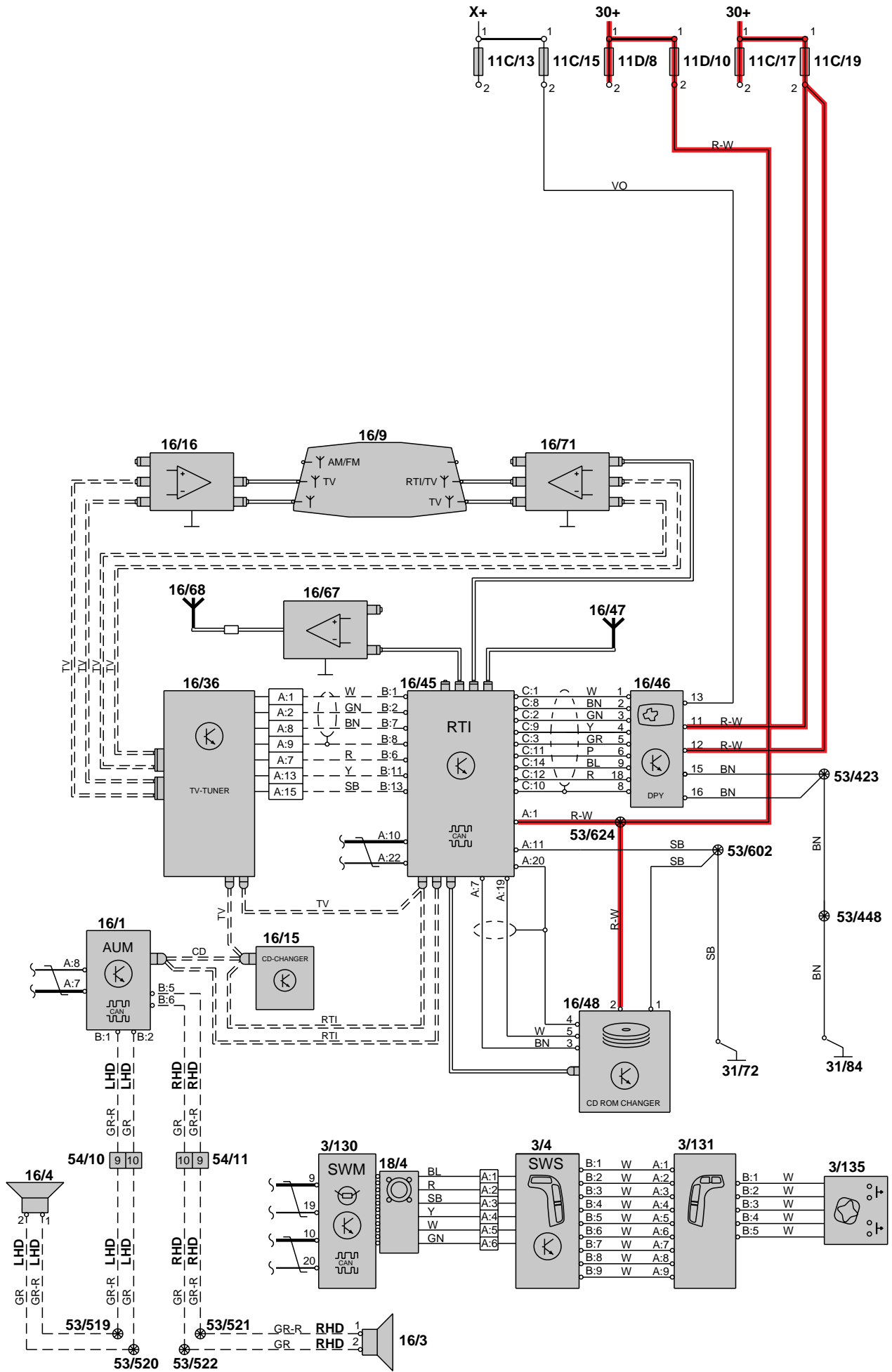

Mobile telephone

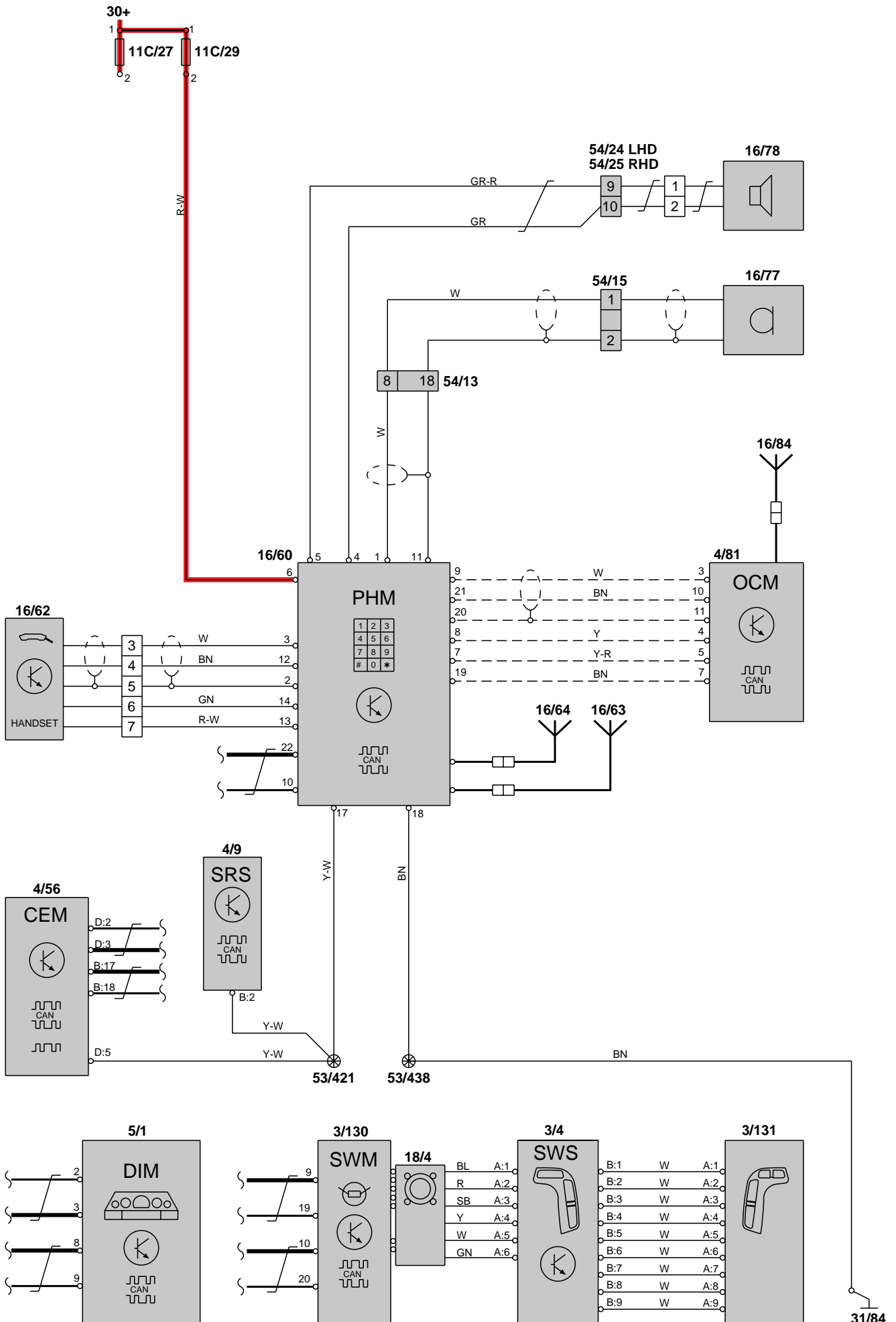

Group 43

Electronically controlled automatic transmission, AW 55-50

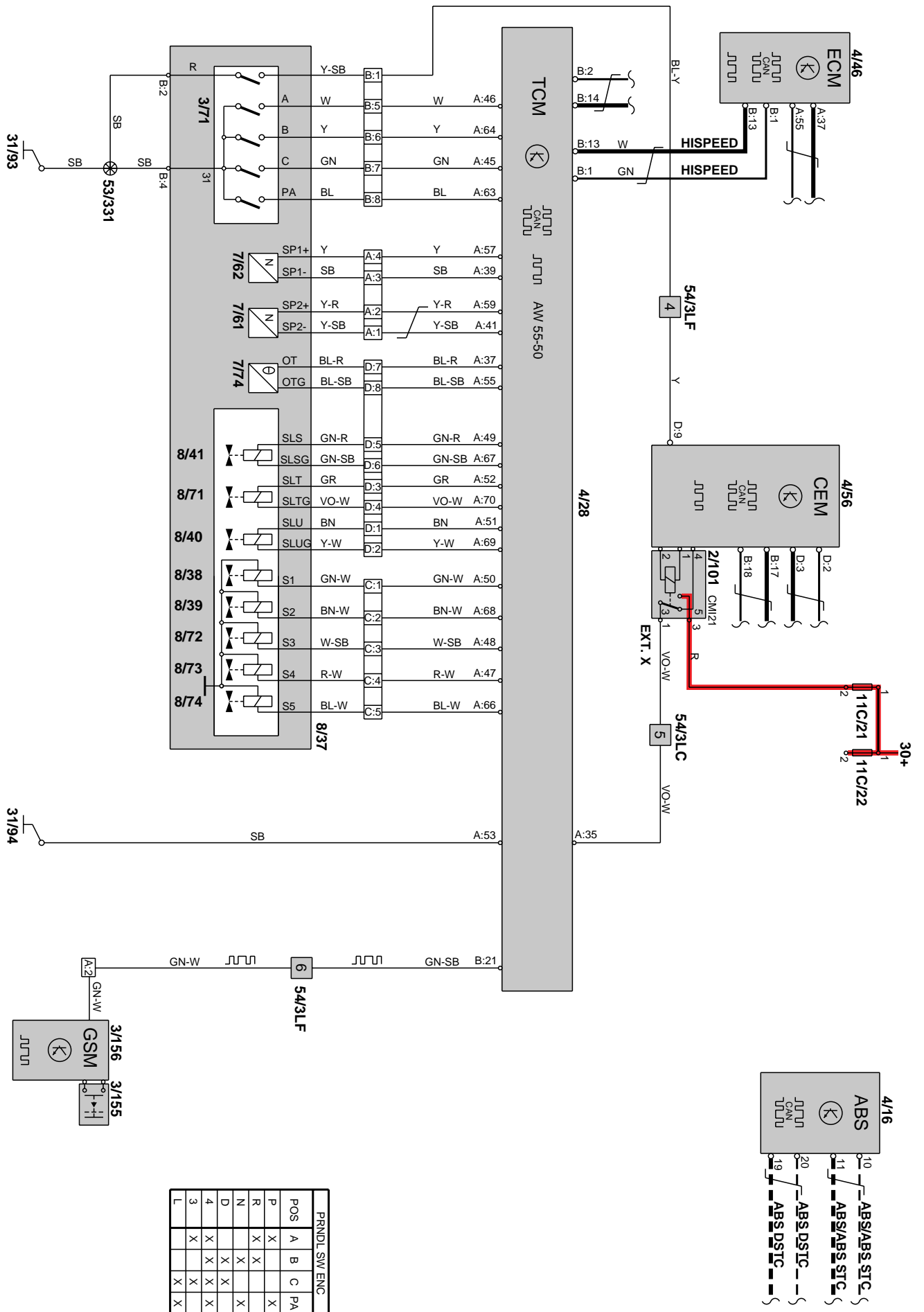

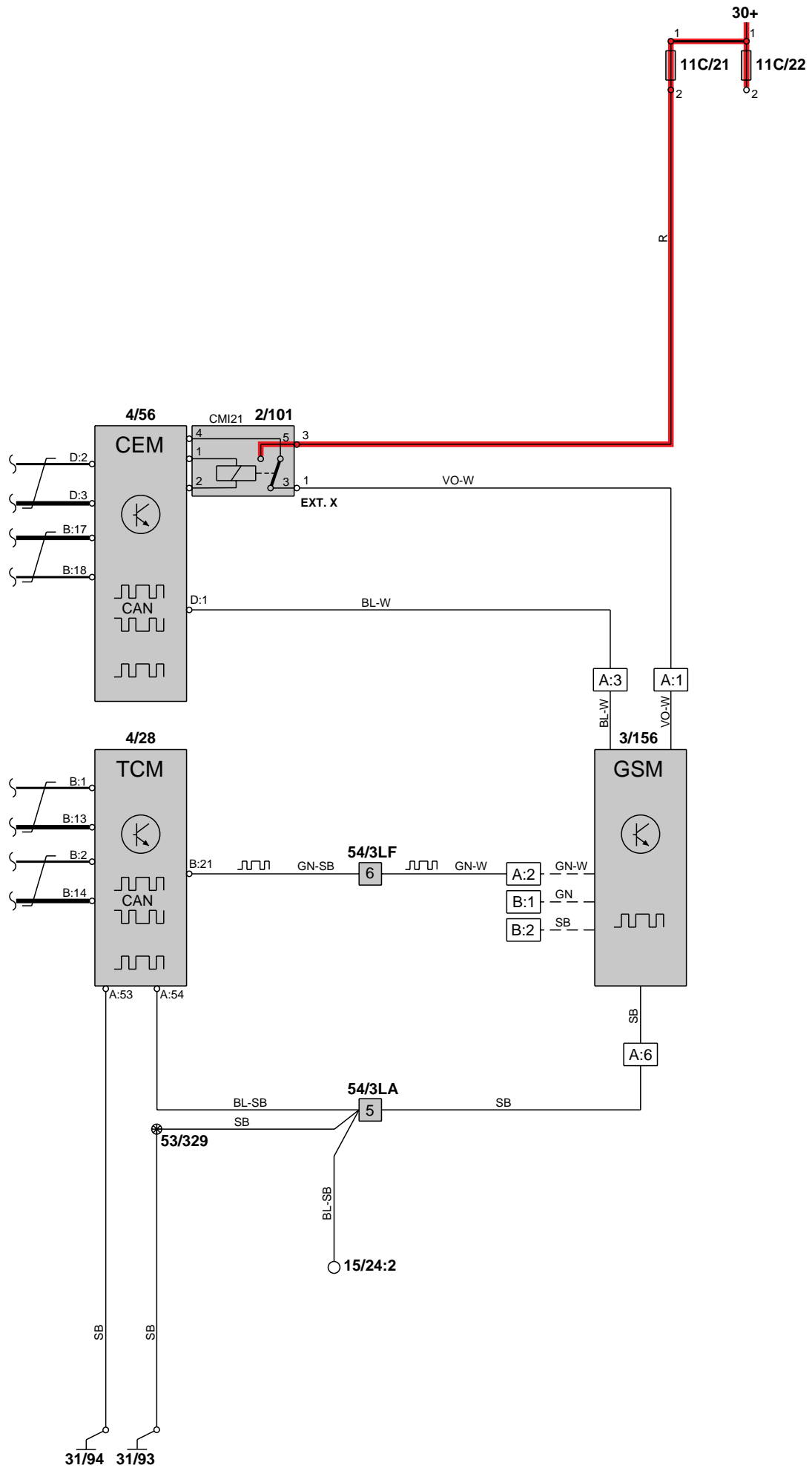

Shift lock

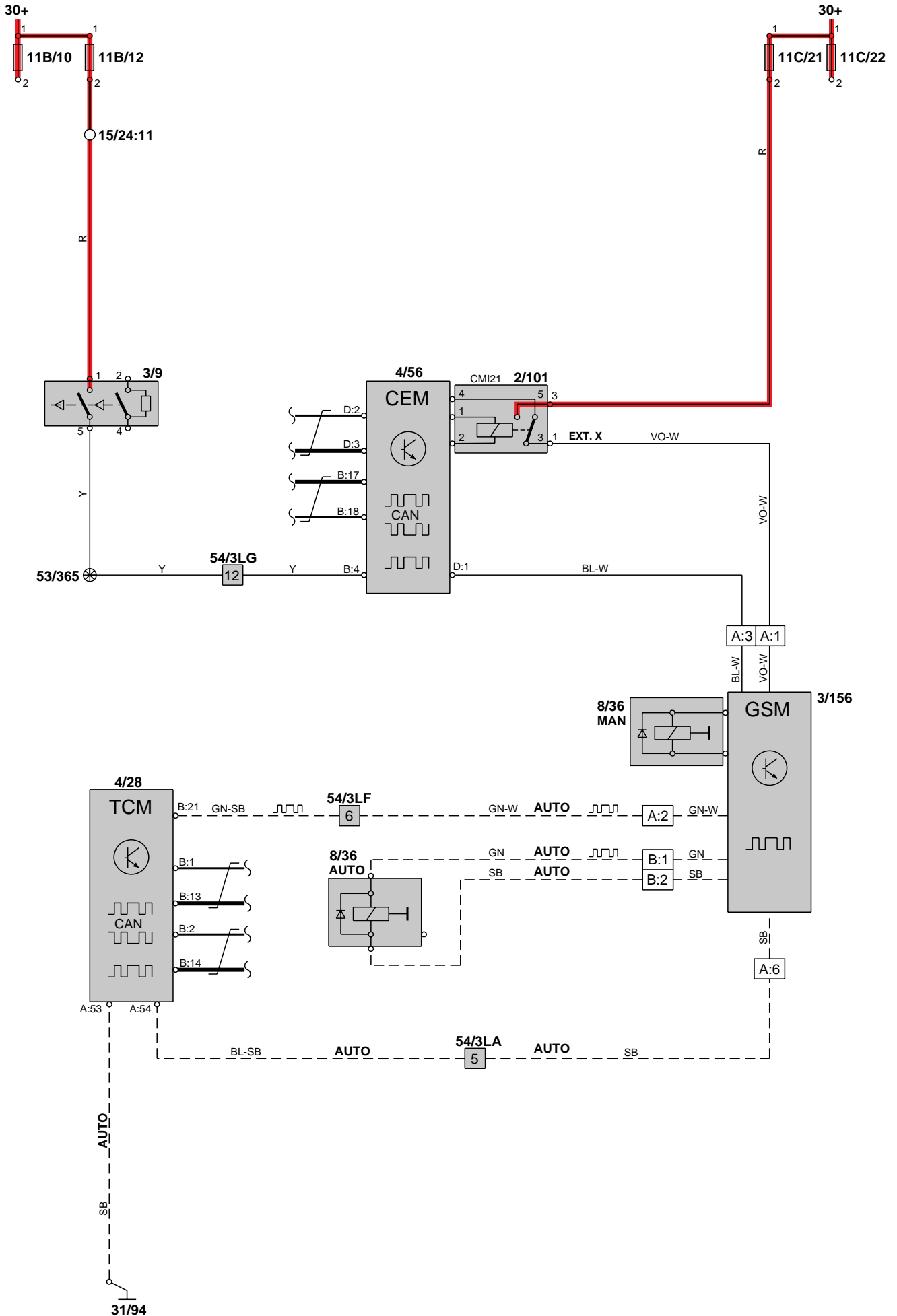

Group 59 ABS and STC

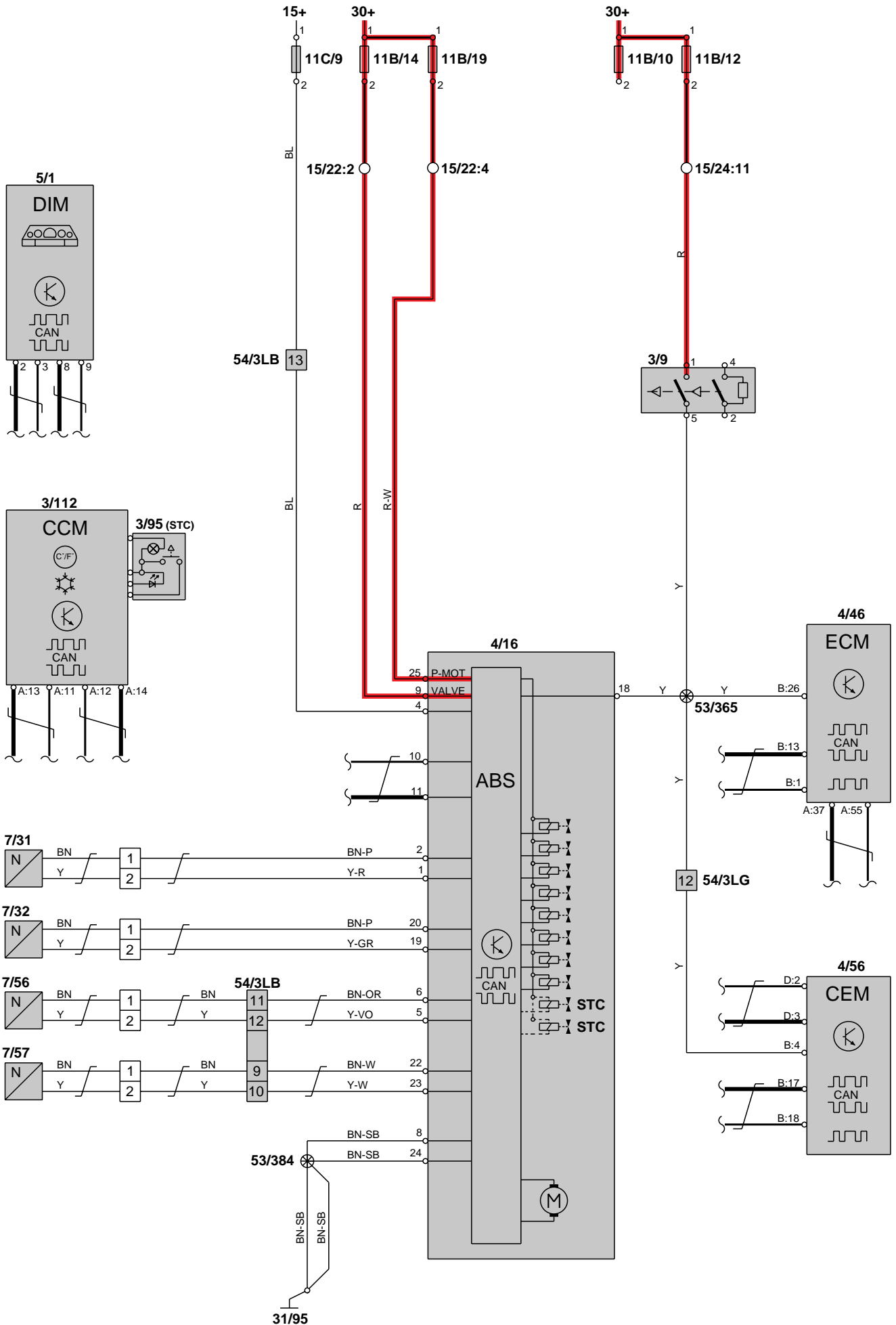

ABS and DSTC

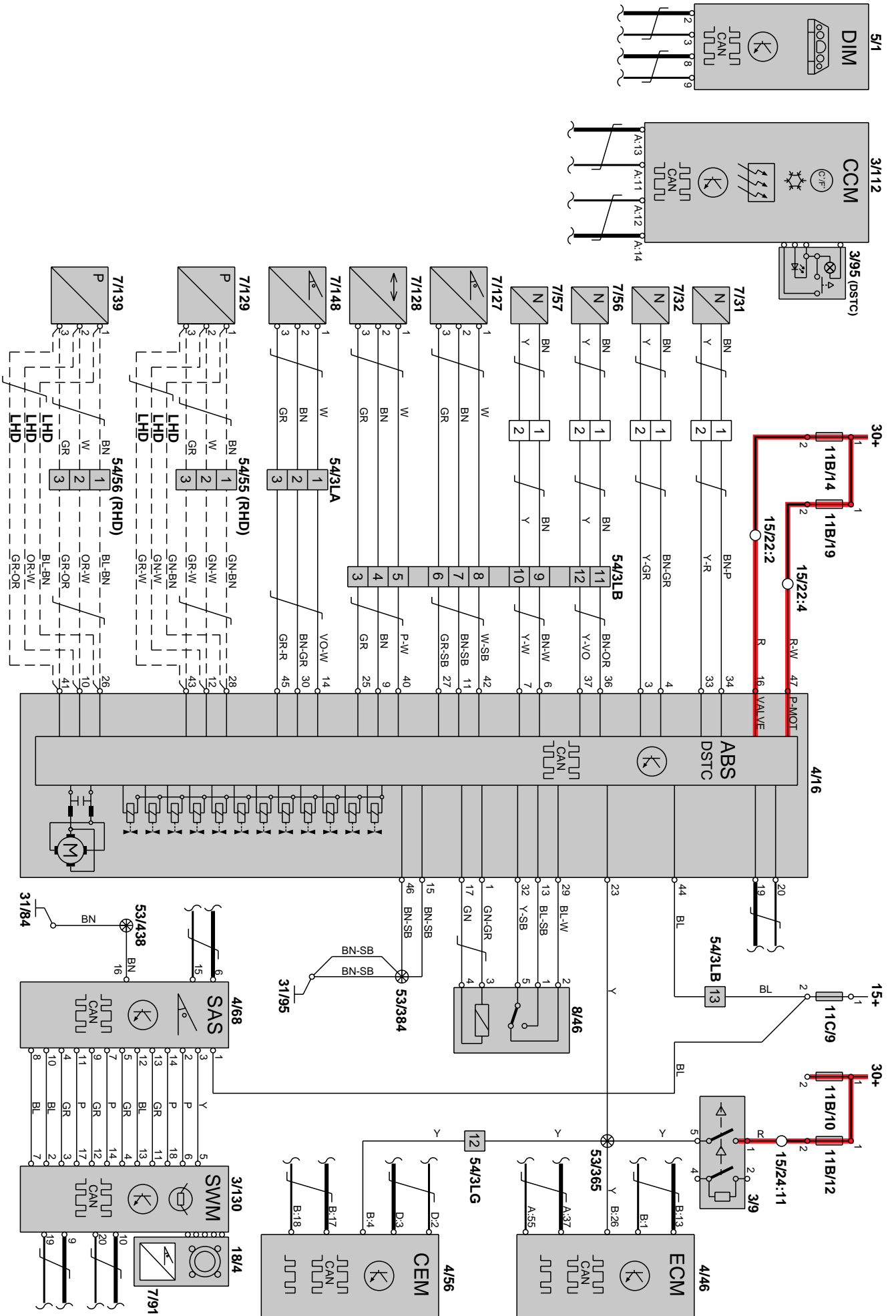

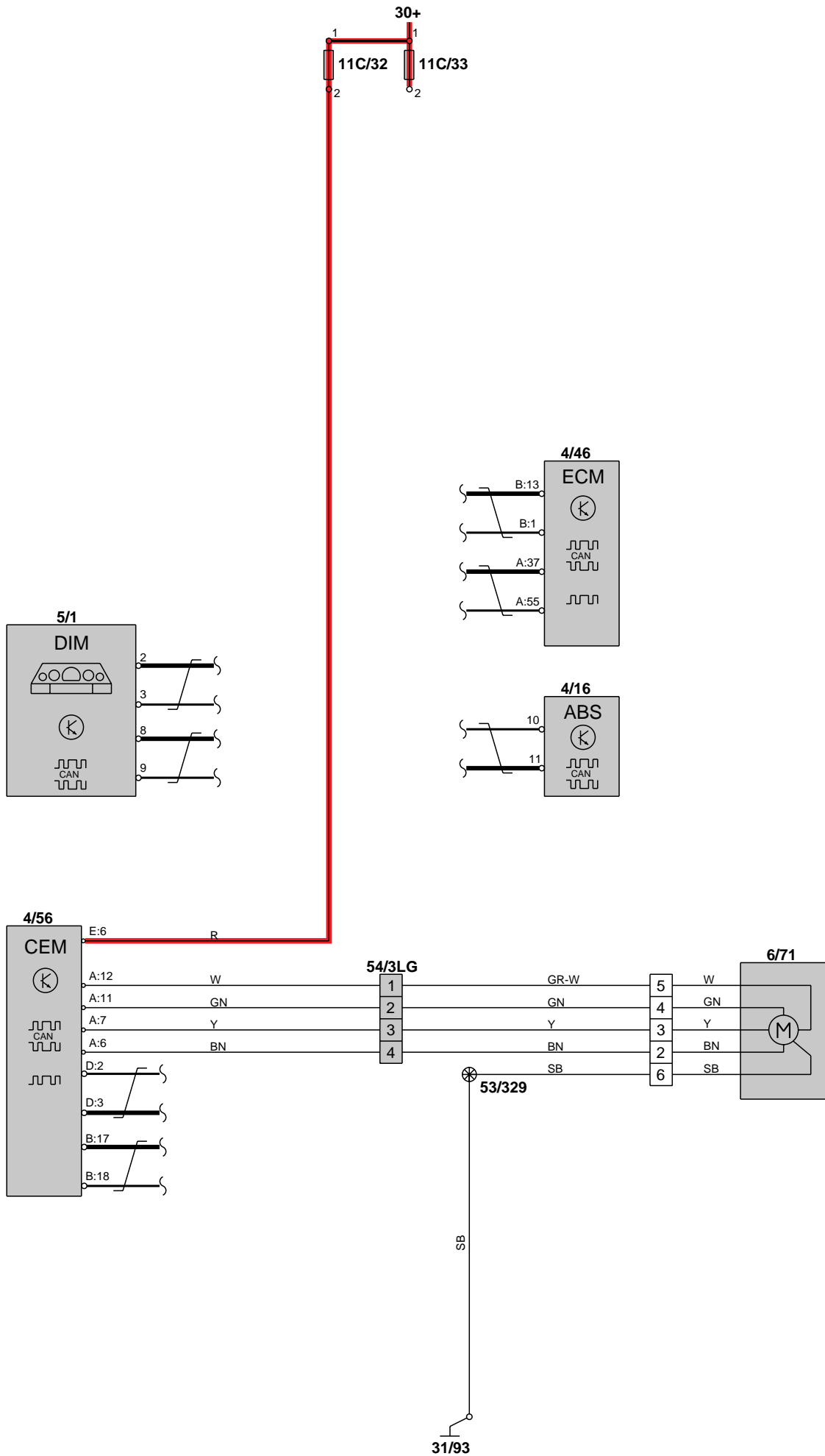

Group 83 Power windows

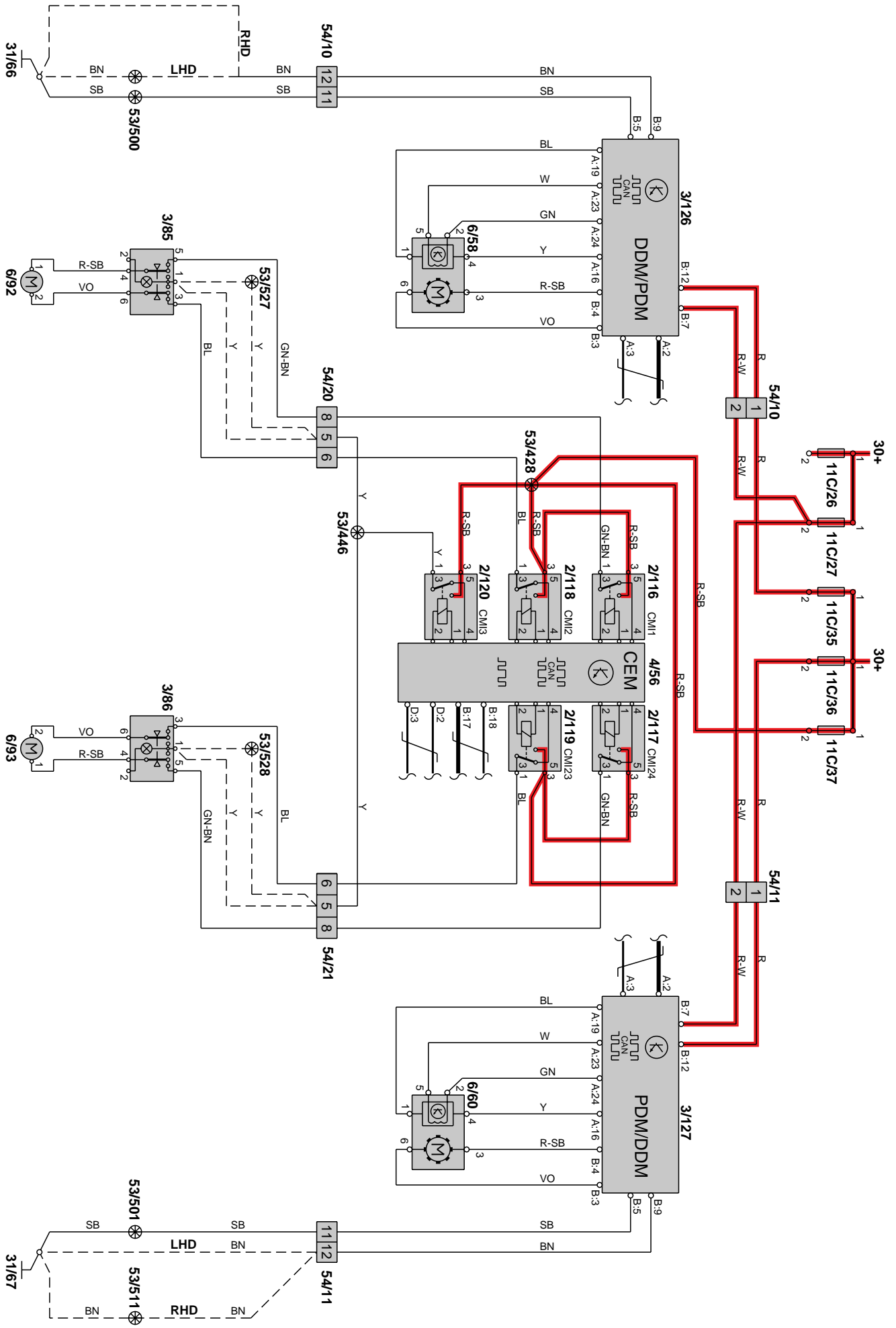

Central lock

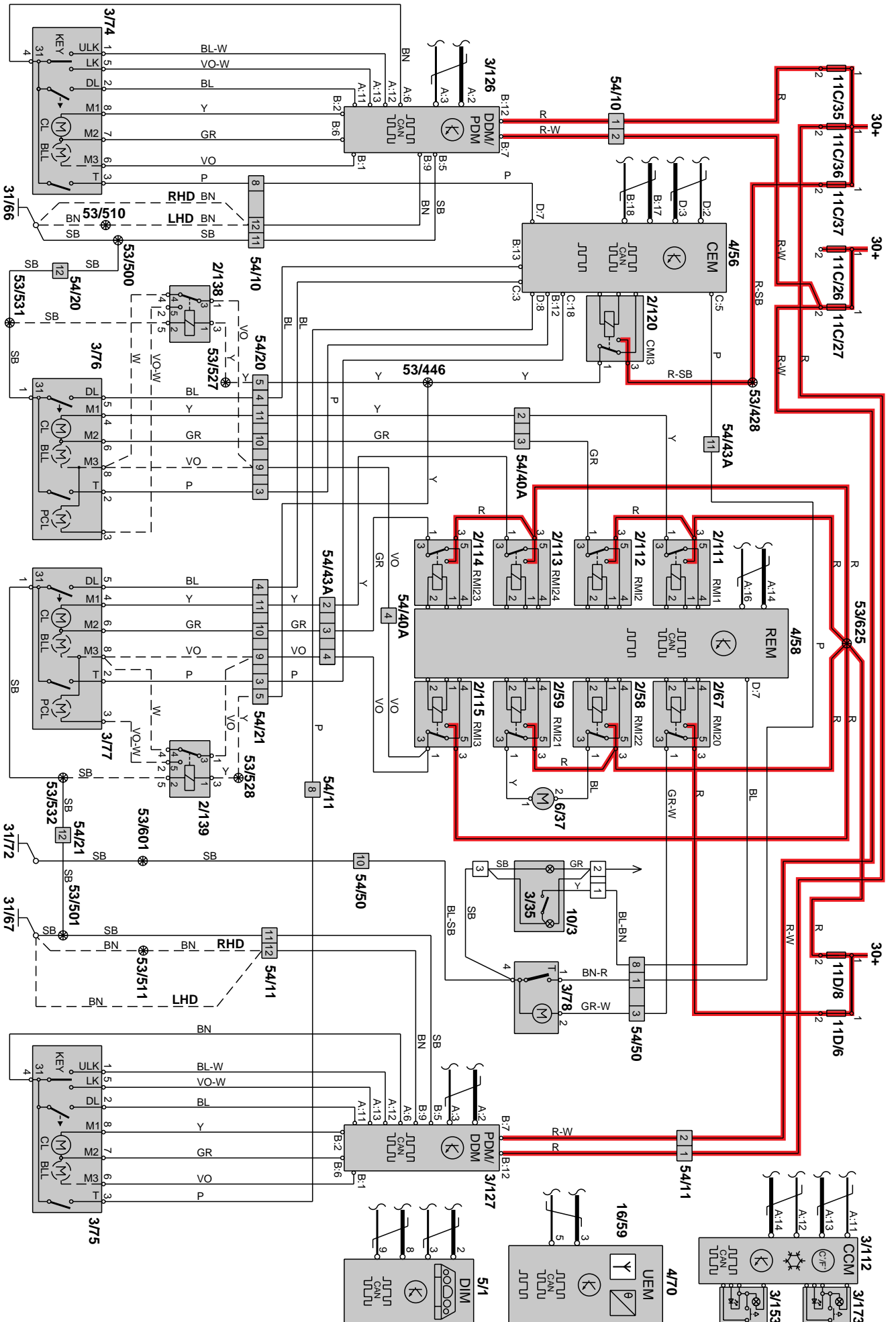

Group 84 Heated rear window

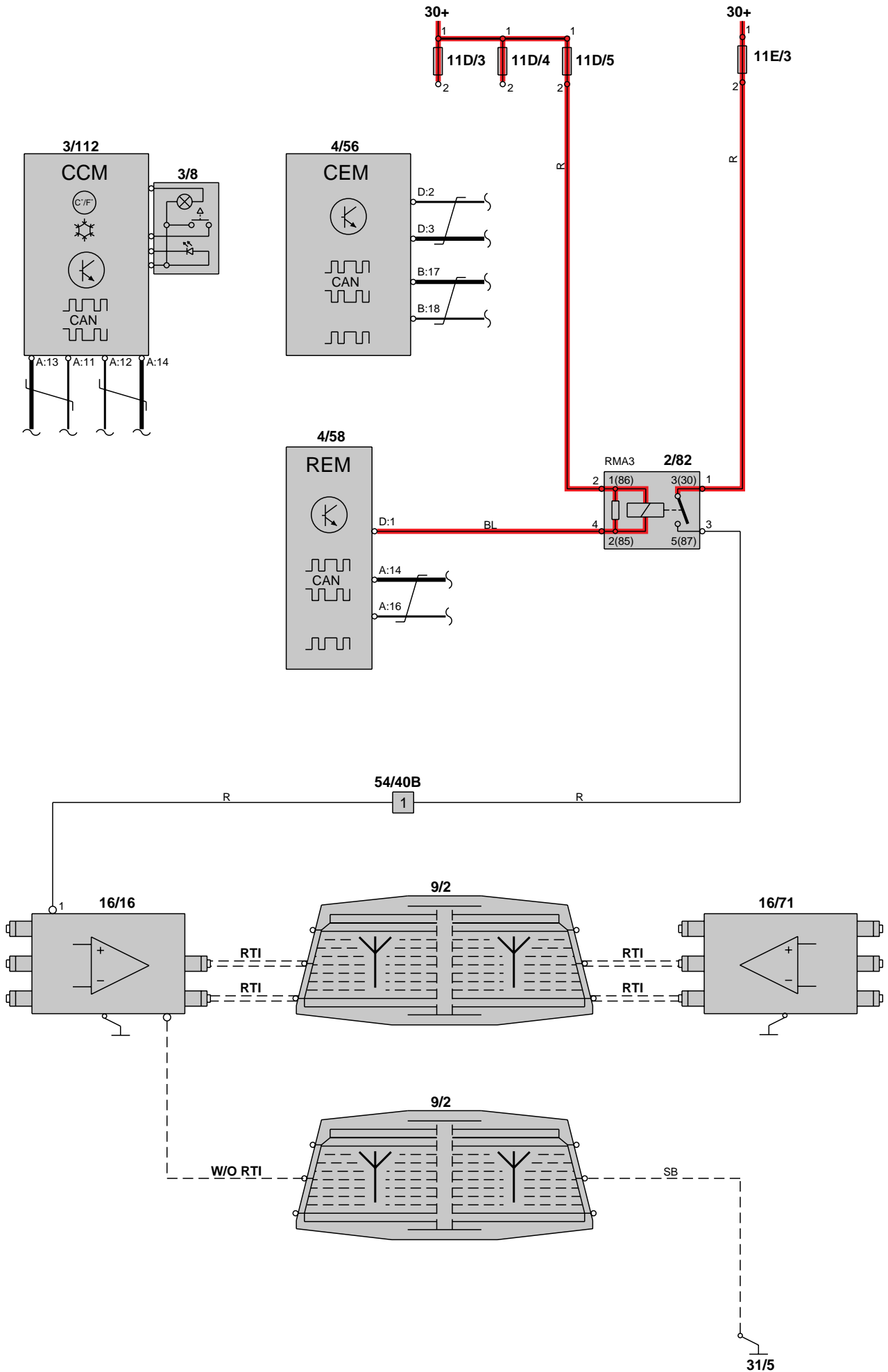

Power sunroof

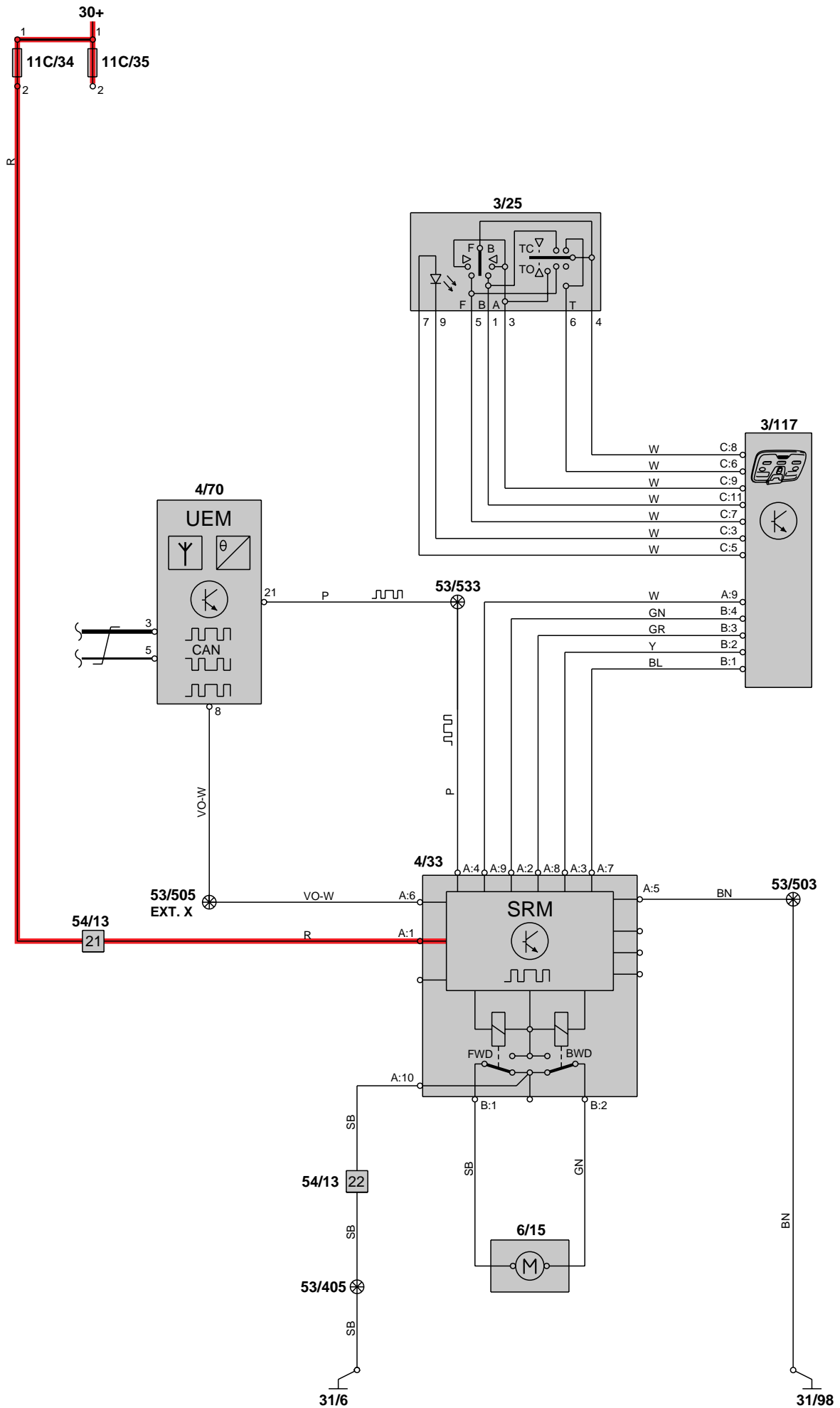

Heated door mirrors

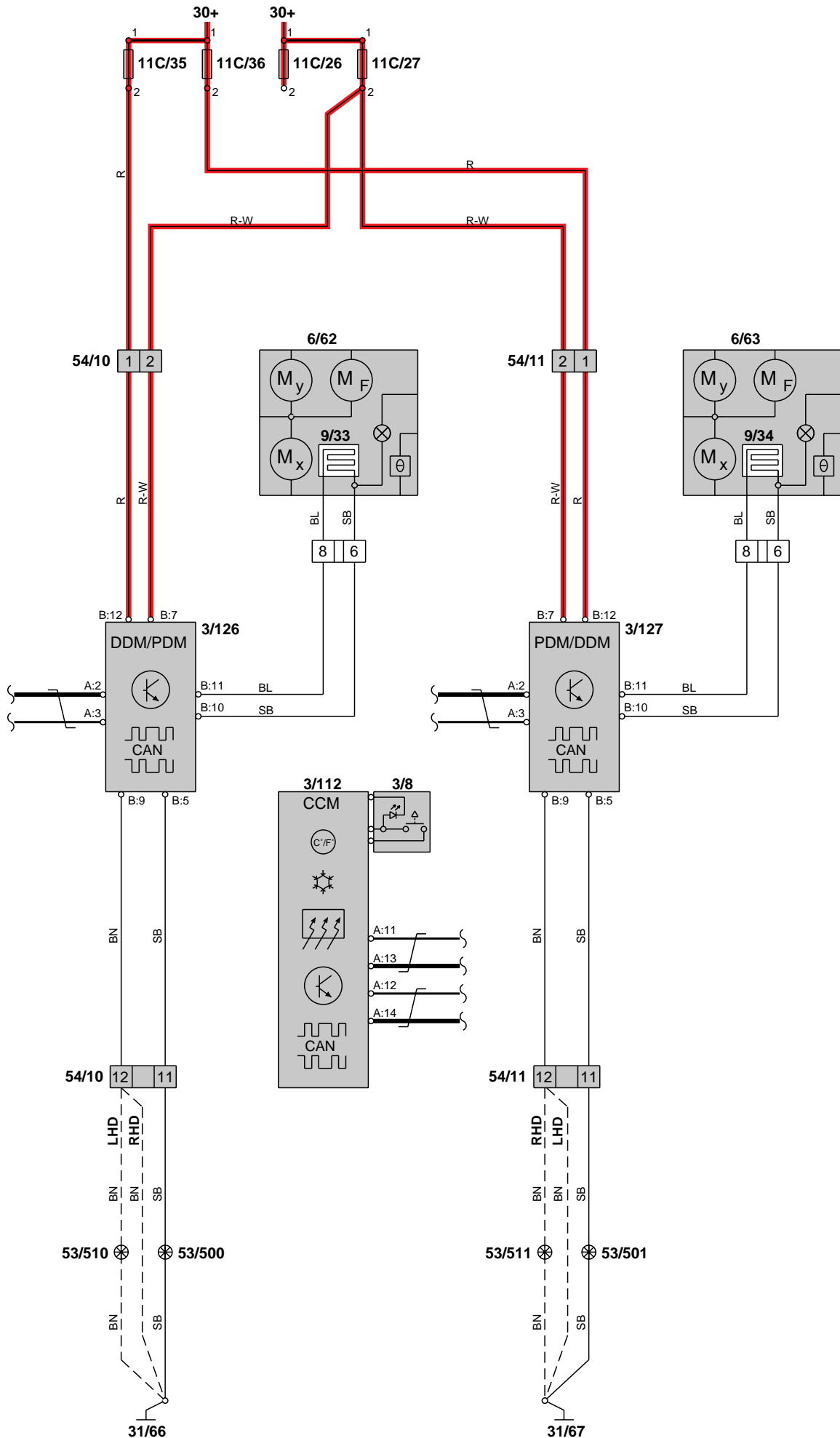

Power door mirrors

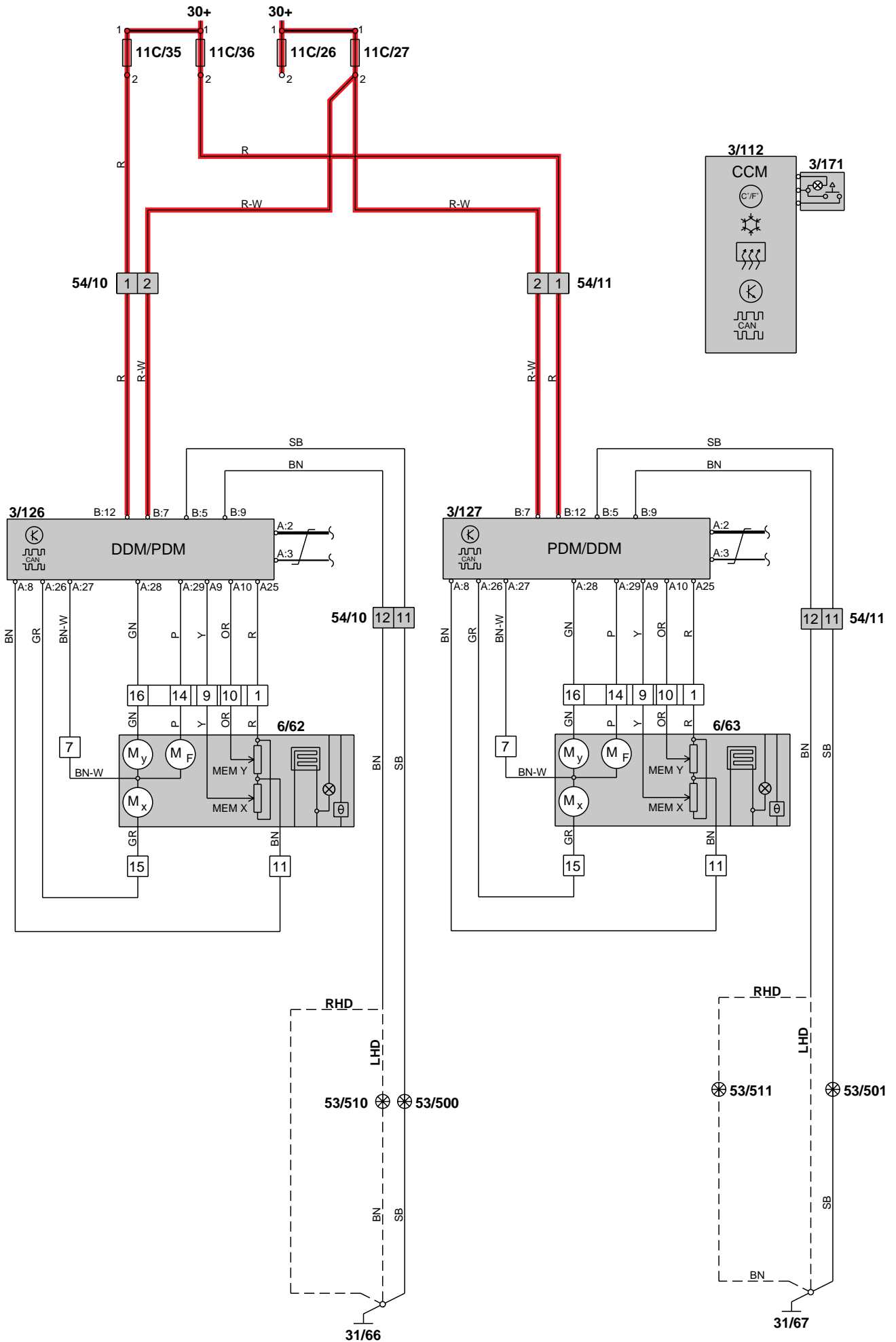

Group 85 Heated seats

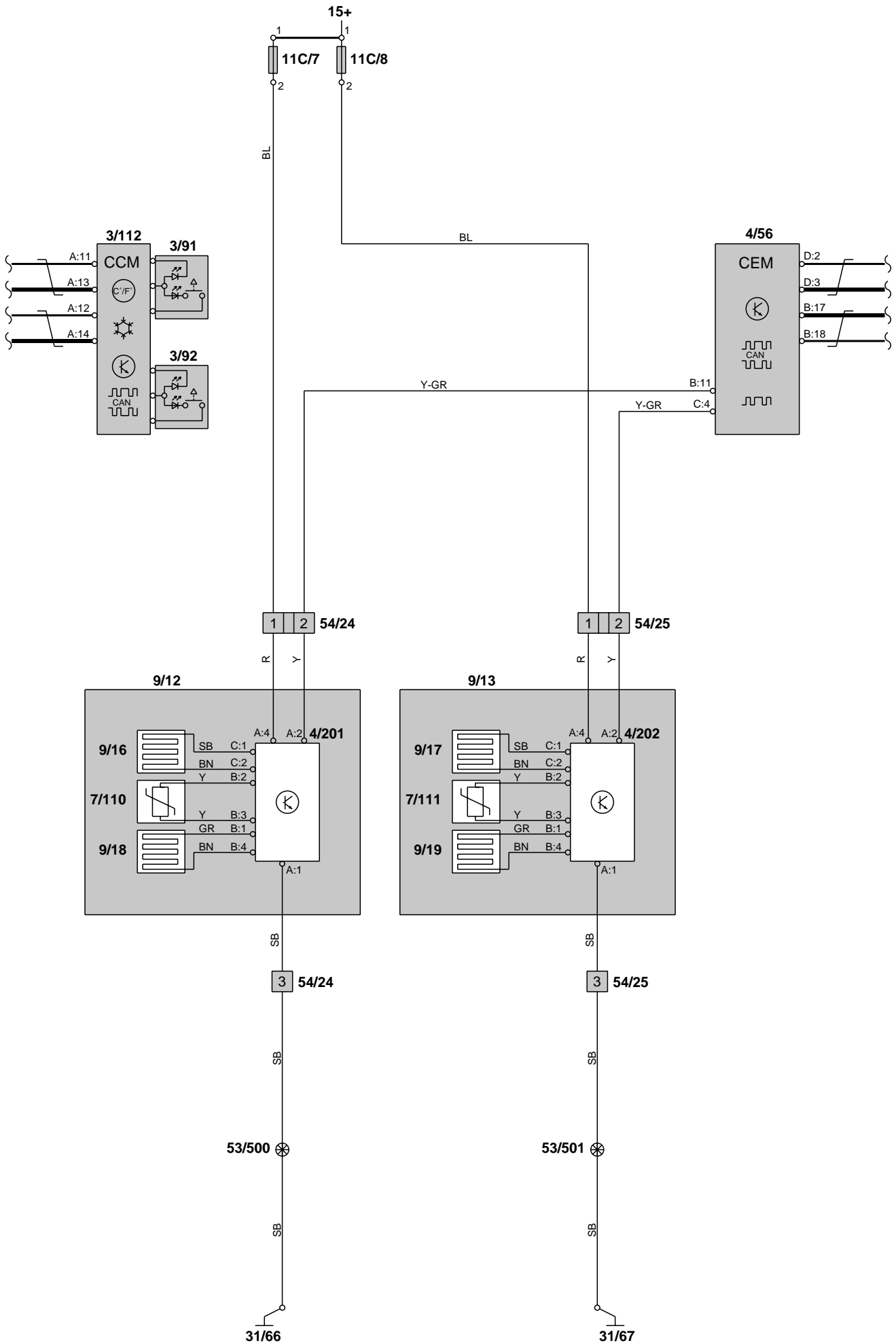

Power driver's seat

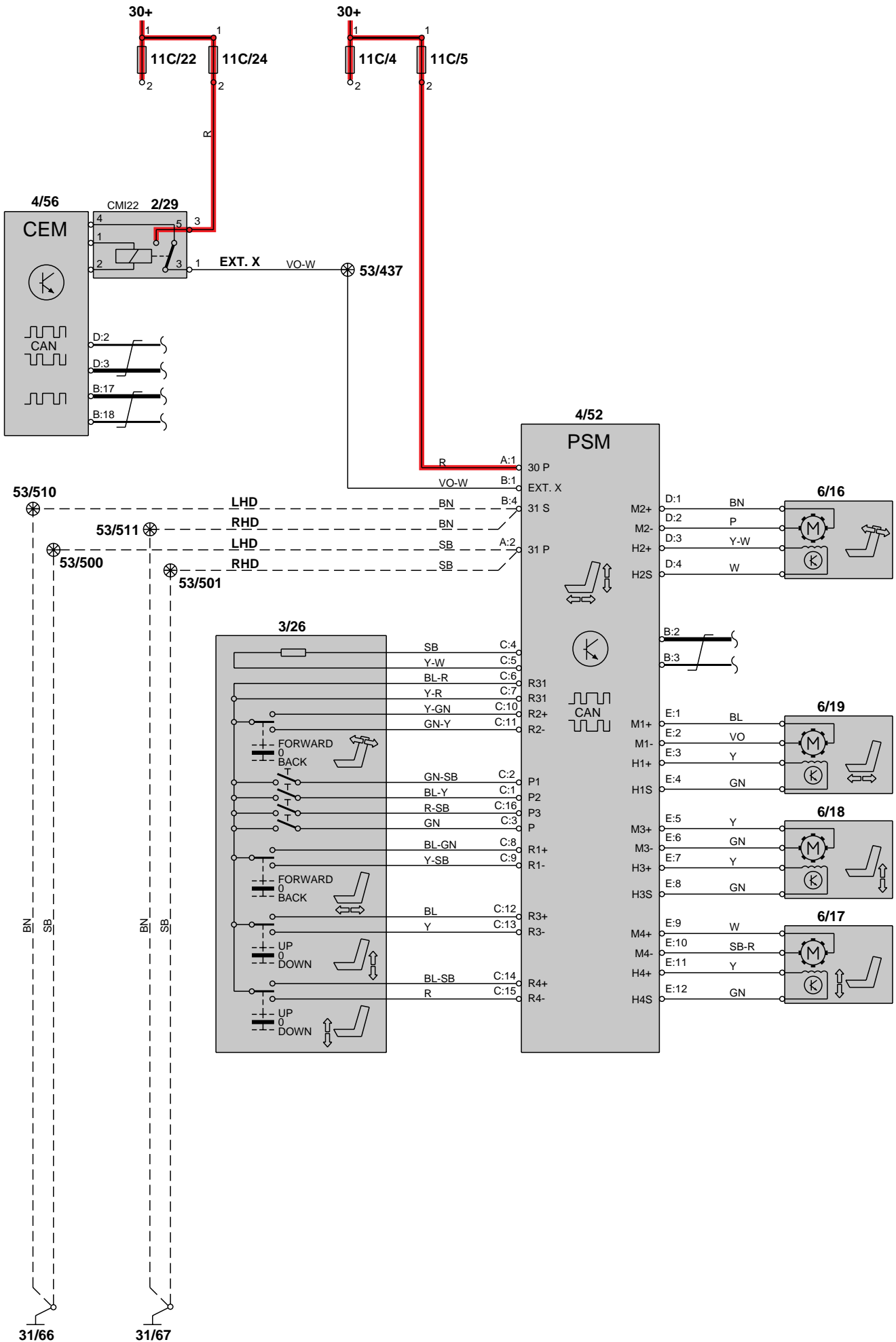

Power passenger seat

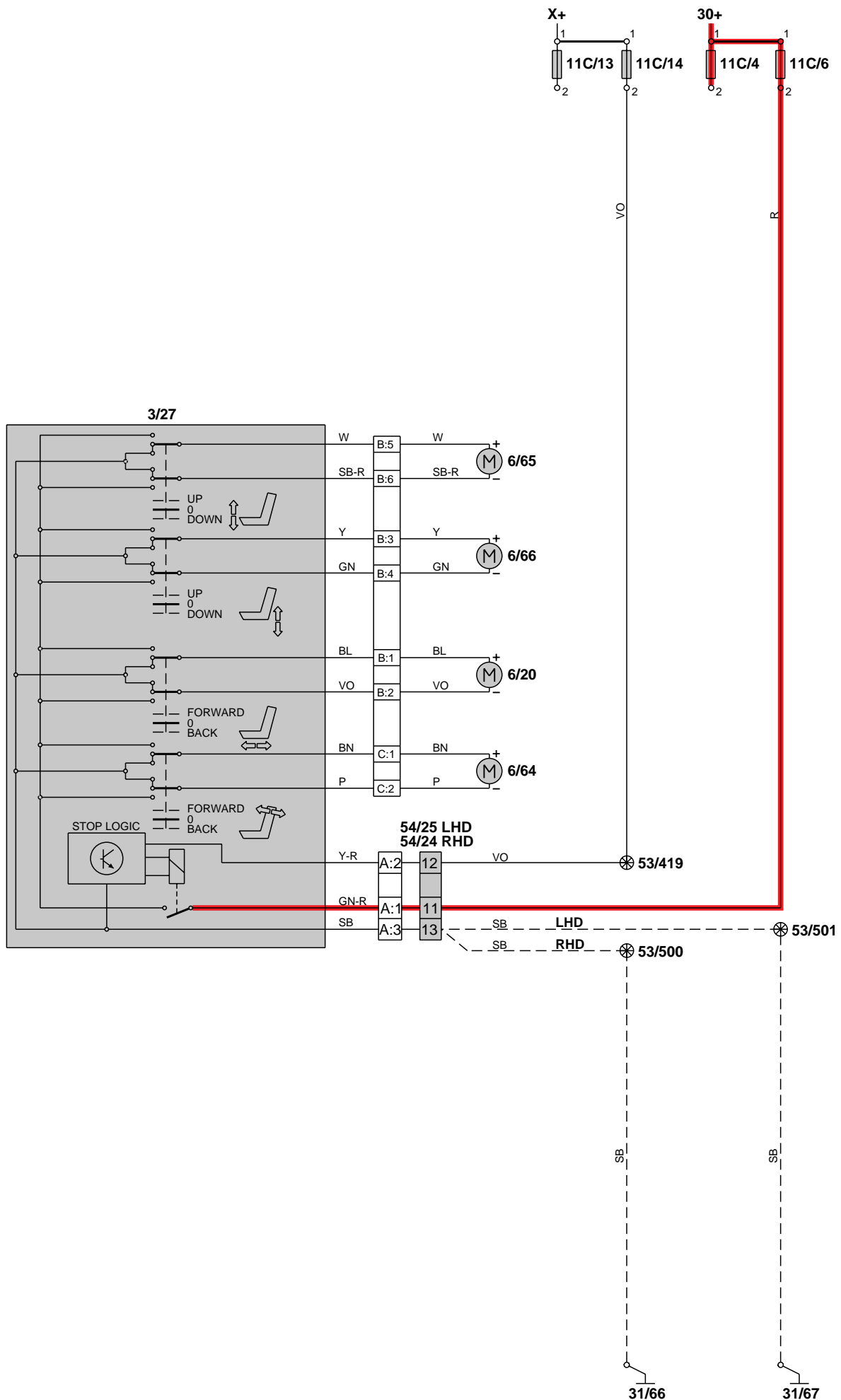

Group 87 Standard heater

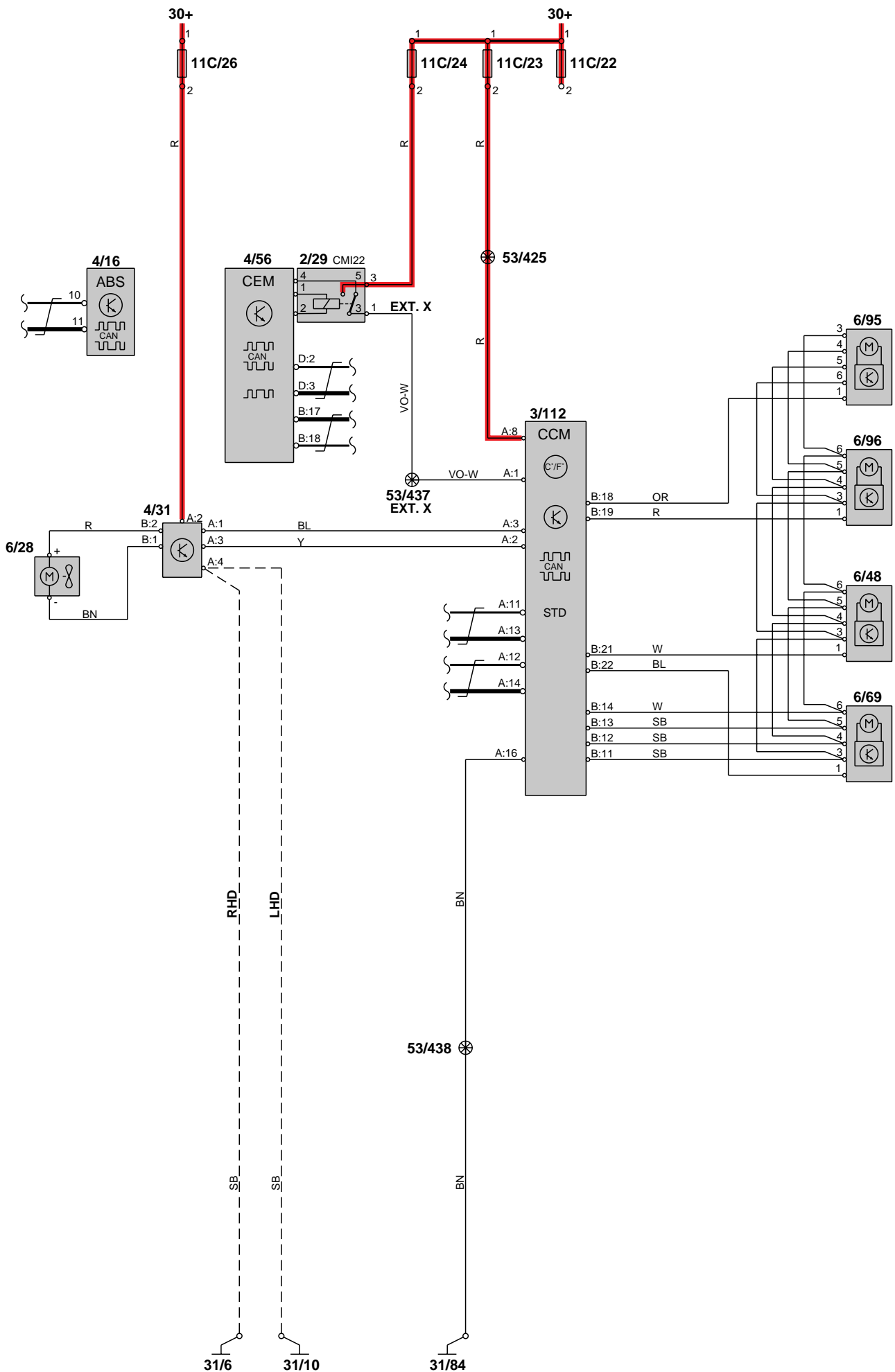

Manual climate control MCC

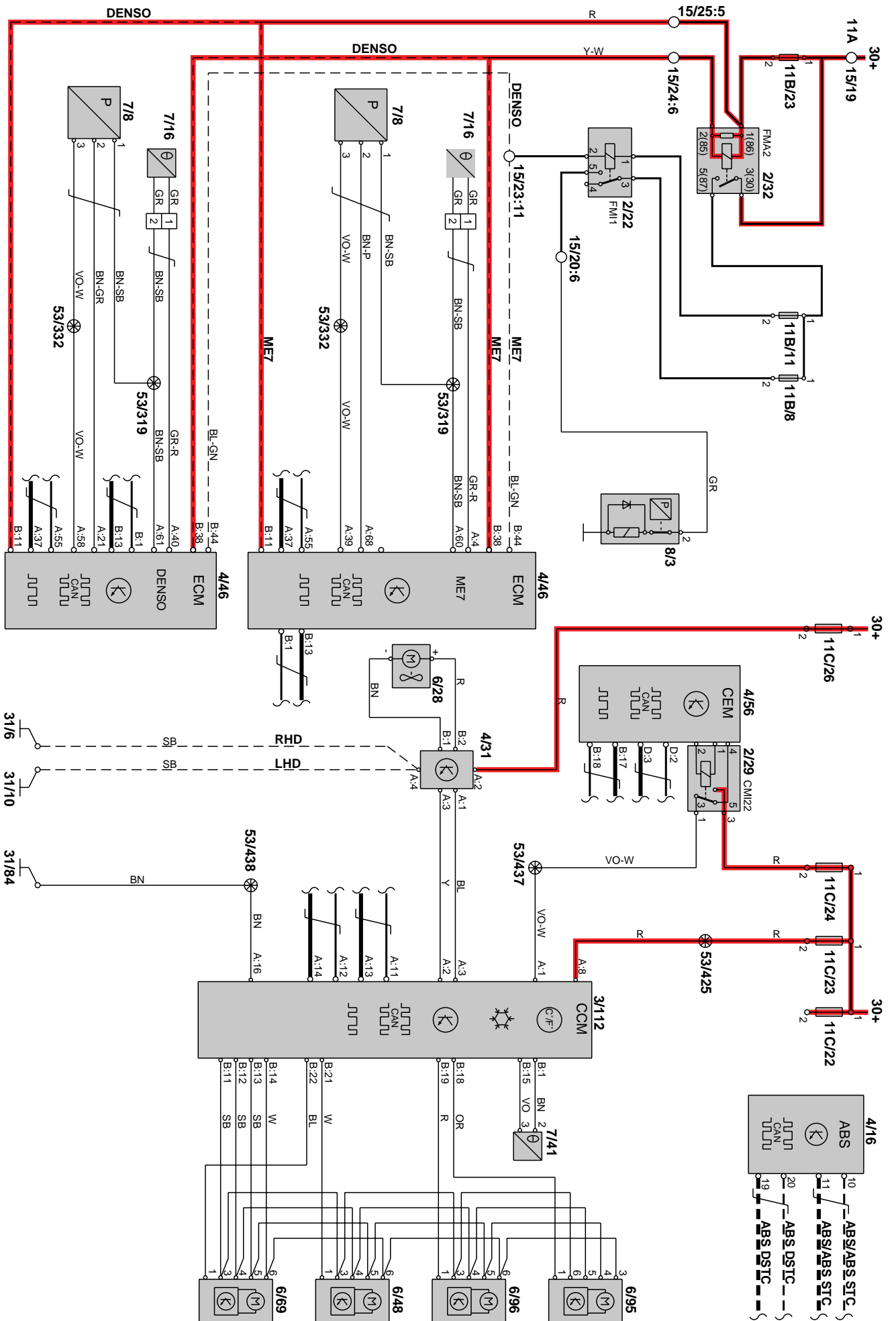

Electronic climate control ECC

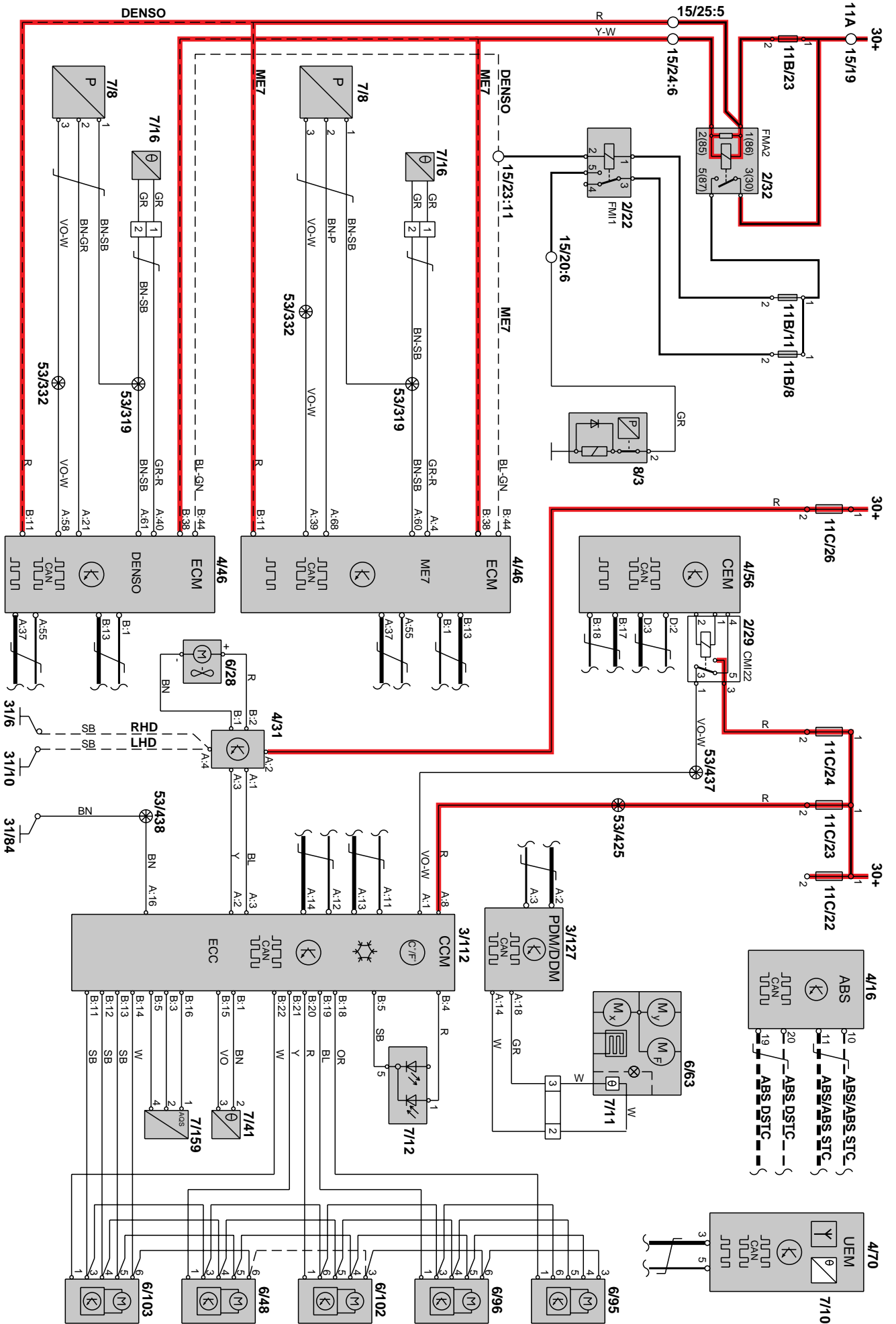

Group 88

Electrically adjustable head restraint

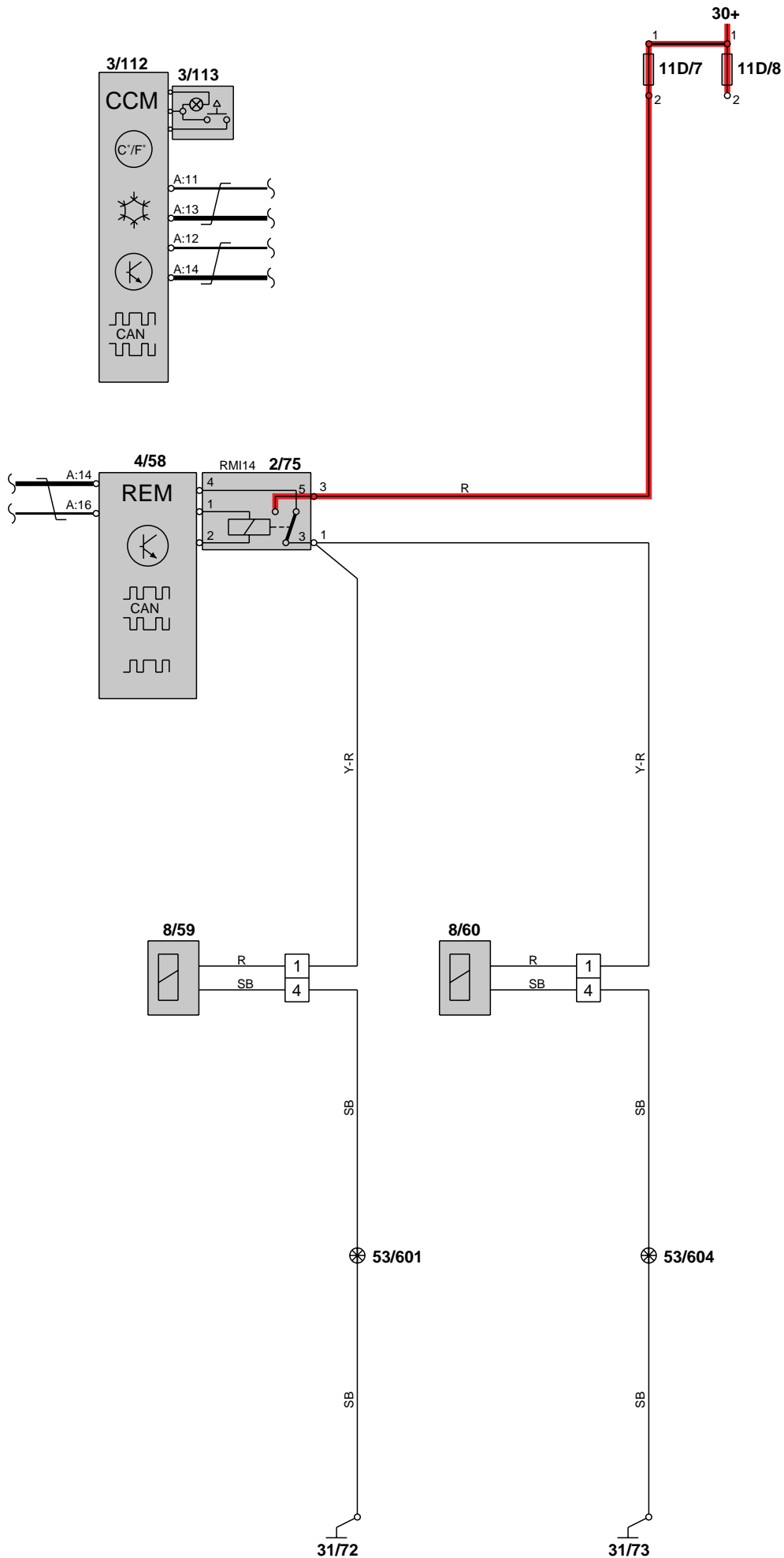

SRS Supplemental Restraint System

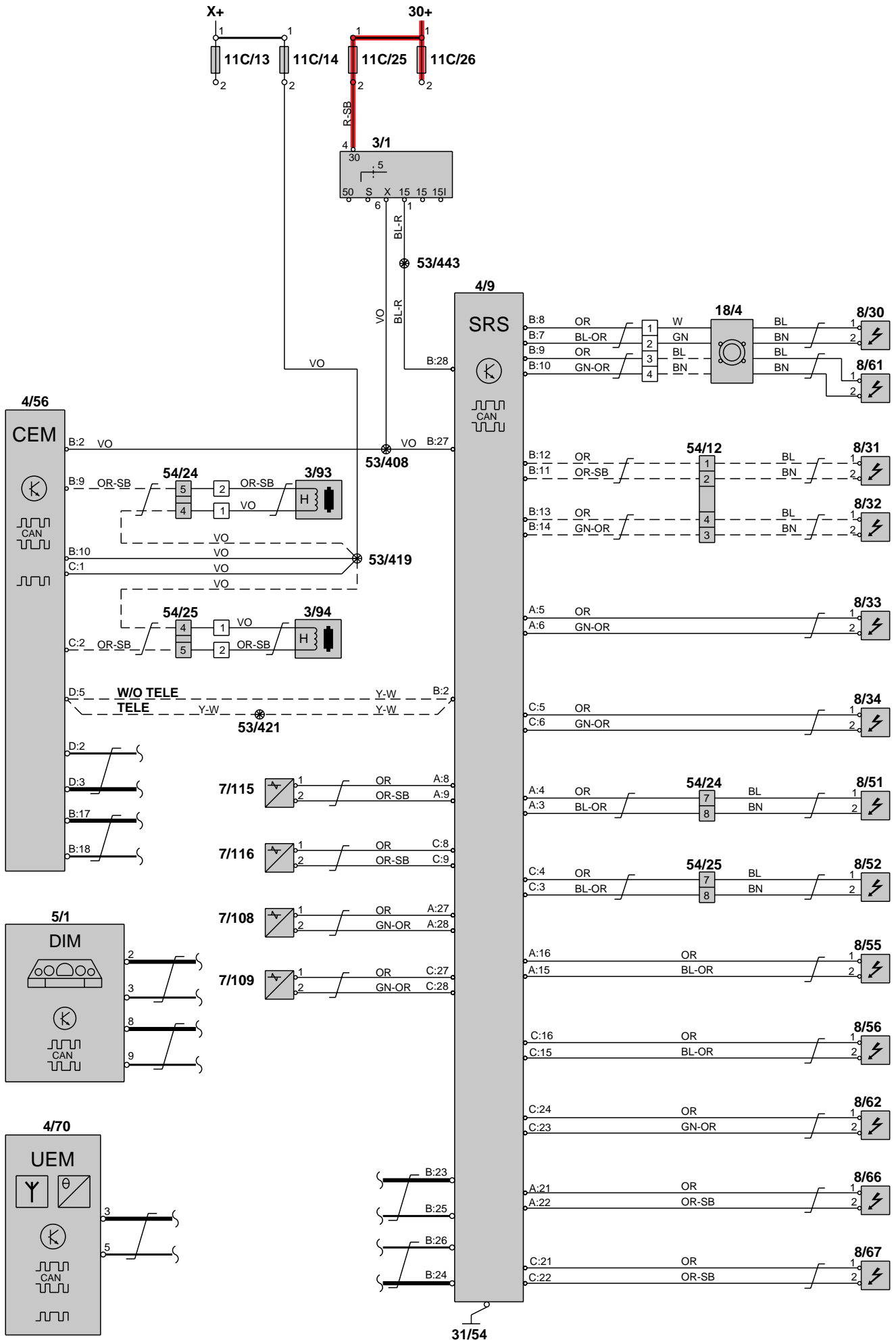

Remote controlled garage opening

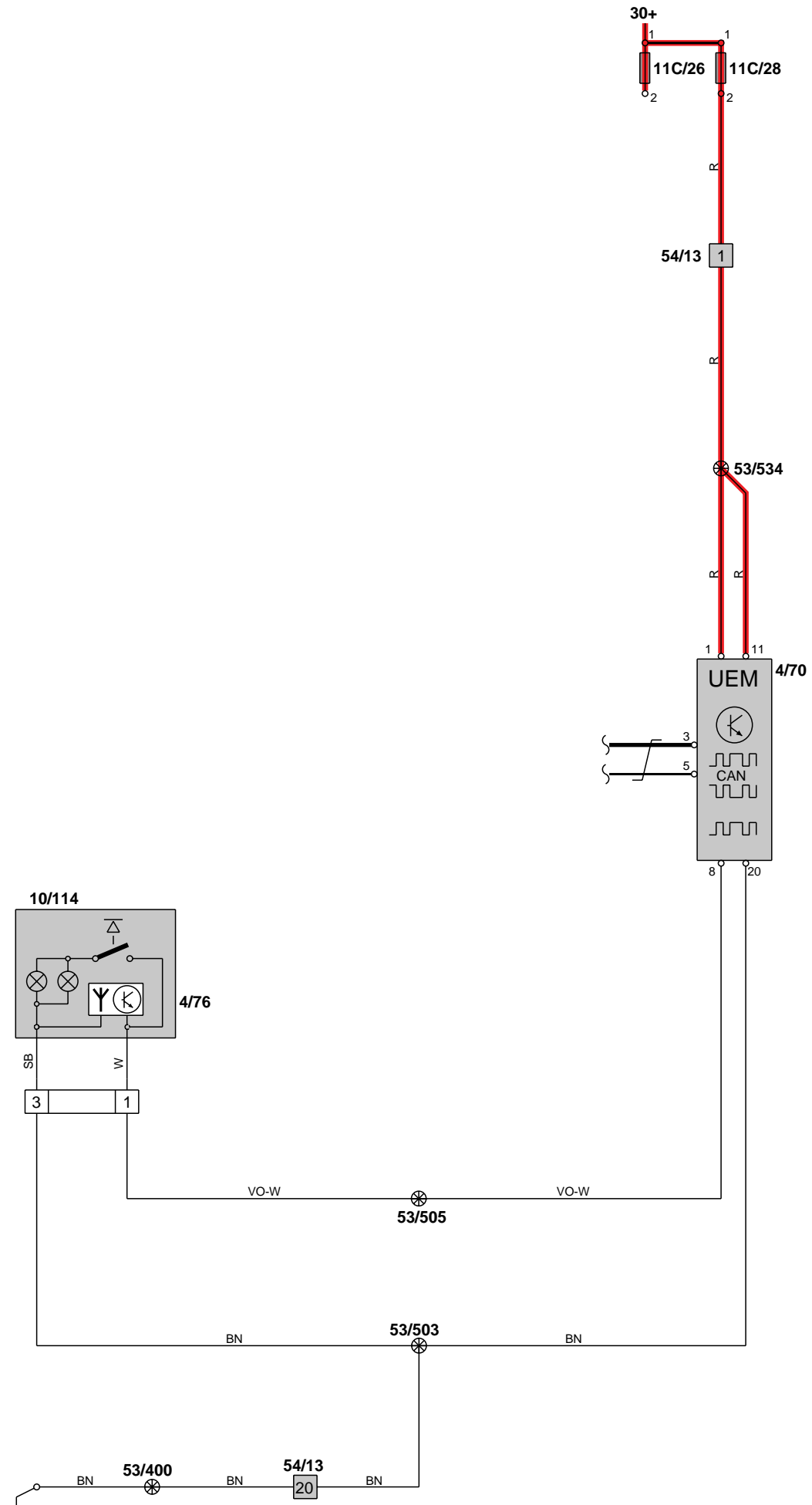

54/3LA 13-pole white

Passenger compartment harness - Engine compartment harness

No.	Passenger compartment harness		Engine compartment harness	
1	Yaw angle sensor 2 7/148:1 DSTC	W	ABS control module 4/16:14	W-VO
2	Yaw angle sensor 2 7/148:2 DSTC	BN	ABS control module 4/16:30	BN-GR
3	Yaw angle sensor 2 7/148:3 DSTC	GR	ABS control module 4/16:45	GR-R
4	Canister shut-off valve 8/44:2	GN	Engine Control Module ECM 4/46B:40	GN-BN
5	Shifter unit automatic transmission GSM 3/156A:6	SB	Control unit TCM 4/28:54 Junction point 53/329	BL-SB SB
6	Tank pressure sensor 7/84:3	W	Engine Control Module ECM 4/46B:10	W-SB
7	CEM 4/56A:19	Y	Horn relay 2/17:2	Y-GR
8	CEM 4/56A:3	BN-W	Starter motor relay 2/35:2	BL-OR
9	Tank pressure sensor 7/84:2	GR	Engine Control Module ECM 4/46B:31	GR-SB
10	-	-	-	-
11	CEM 4/56A:16	BL	Relay, windshield washer motor 2/92:2	BL-R
12	CEM 4/56A:14	Y	Relay, windshield wiper, low/high speed 2/90:2	Y-GR
13	CEM 4/56A:13	GR	Relay, intermittent windshield wiper 2/91:2	GR

54/3LB 13-pole white

Passenger compartment harness - Engine compartment harness

No.	Passenger compartment harness		Engine compartment harness	
1	Tank pressure sensor 7/84:1	BN	Junction point 53/324	BN
2	CEM 4/56B:14	BL	Engine Control Module ECM 4/46B:45	R-SB
3	Lateral acceleration meter 7/128:3 DSTC	GR	ABS control module 4/16:25	GR
4	Lateral acceleration meter 7/128:2 DSTC	BN	ABS control module 4/16:9	BN
5	Lateral acceleration meter 7/128:1 DSTC	W	ABS control module 4/16:40	P-W
6	Yaw angle sensor 1 7/127:3 DSTC	GR	ABS control module 4/16:27	GR-SB
7	Yaw angle sensor 1 7/127:2 DSTC	BN	ABS control module 4/16:11	BN-SB
8	Yaw angle sensor 1 7/127:1 DSTC	W	ABS control module 4/16:42	W-SB
9	RH rear ABS sensor 7/57:1	BN	ABS control module 4/16:22 ABS control module 4/16:6 DSTC	BN-W
10	RH rear ABS sensor 7/57:2	Y	ABS control module 4/16:23 ABS control module 4/16:7 DSTC	Y-W
11	LH rear ABS sensor 7/56:1	BN	ABS control module 4/16:6 ABS control module 4/16:36 DSTC	BN-OR
12	LH rear ABS sensor 7/56:2	Y	ABS control module 4/16:5 ABS control module 4/16:37 DSTC	Y-VO
13	Fuse protection for 11C/9:2	BL	ABS control module 4/16:4 ABS control module 4/16:44 DSTC	BL

Connector

54/3LC - 54/3LD

54/3LC 6-pole white

Passenger compartment harness - Engine compartment harness

No.	Passenger compartment harness		Engine compartment harness	
1	Canister shut-off valve 8/44:1	GN-GR	Fuse 11B/5:2	GN-GR
2	Connector 54/10:6	BN	Junction point 53/324	BN
3	Connector 54/10:5	W	Engine Control Module ECM 4/46B:29	OR-W
4	CEM 4/56A:20 Ignition switch 3/1:7	Y-W	Starter motor relay 2/35:1 Engine Control Module ECM 4/46B:23	GN-R
5	Relay for extended X feed, automatic transmission 2/101:1	VO-W	Control unit TCM 4/28A:35	VO-W
6	Turn signal shunt CEM left 20/32:2	GN	LH front fender turn signal 10/15:2 LH front lamp housing 10/1B:2	GN

54/3LD 4-pole white

Passenger compartment harness - Engine compartment harness

No.	Passenger compartment harness		Engine compartment harness	
1	-	-	-	-
2	Junction point 53/402	R	Connecting rail relay/fusebox 15/21:2	R-W
3	Junction point 53/403	R	Connecting rail relay/fusebox 15/28:1	R
4	Turn signal shunt CEM right 20/34:2	GN-W	RH front fender turn signal 10/16:2 RH front lamp housing 10/2B:2	GN-W

54/3LE 6-pole white
Passenger compartment harness - Engine compartment harness

No.	Passenger compartment harness		Engine compartment harness	
1	Junction point 53/443	BL-R	Engine Control Module ECM 4/46B:37	BL-R
2	Fuse 11C/11:2	BL	RH front lamp housing 10/2A:4	BL-Y
3	Fuse 11C/2:2	BL-W	RH front lamp housing 10/2A:3	BL-W
4	Fuse 11C/1:2	BL-W	LH front lamp housing 10/1A:3	BL-W
5	Fuse 11C/10:2	BL	LH front lamp housing 10/1A:4	BL
6	Fog light relay, front 2/34:1	P	Foglight front right 10/6:1 Foglight front left 10/5:1	P

54/3LF 13-pole white
Passenger compartment harness - Engine compartment harness

No.	Passenger compartment harness		Engine compartment harness	
1	Combined instrument panel DIM 5/1	GR	Engine Control Module ECM 4/46B:46	GR
2	CEM 4/56A:5	R-W	6/26B:1	R-W
3	CEM 4/56A:1	Y-GR	3/10:2	Y-GR
4	CEM 4/56D:9	Y	Automatic transmission solenoids 8/37B:1	BL-Y
5	CEM 4/56D:6 Data link connector 17/13:7	W	Engine Control Module ECM 4/46B:22 Control unit TCM 4/28B:22	W-SB
6	Shifter unit automatic transmission GSM 3/156A:2	GN-W	Control unit TCM 4/28B:21	GN-SB
7	Fuse 11C/38:2	R	Alarm siren SCM 16/35:1	R
8	CEM 4/56B:16 Connector 54/13:14	W	Windshield wiper motor 6/1:3	BL-W
9	Combination instrument DIM 5/1:5	Y-R	Brake fluid level sensor 7/4:1	Y-R
10	Fuse 11C/31:2	GR	Junction point 53/379	GR
11	Fuse 11C/30:2	W	Junction point 53/378	W
12	Junction point 53/437	VO-W	Connector 54/9:4	VO-W
13	CEM 4/56A:18 Light Switch Module LSM 3/111:3	GN-W	Connector 54/9:6	GN-W

Connector

54/3LG - 54/4

54/3LG 13-pole white

Passenger compartment harness - Engine compartment harness

No.	Passenger compartment harness		Engine compartment harness	
1	CEM 4/56A:12	W	Stepper motor, speed-dependent power steering 6/71:5	GR-W
2	CEM 4/56A:11	GN	Stepper motor, speed-dependent power steering 6/71:4	GN
3	CEM 4/56A:7	Y	Stepper motor, speed-dependent power steering 6/71:3	Y
4	CEM 4/56A:6	BN	Stepper motor, speed-dependent power steering 6/71:2	BN
5	Connector 54/13:15	P	Foglight front left 10/5:1	P
6	Junction point 53/430 CEM 4/56B:17	W	Junction point 53/352	W
7	Junction point 53/431 CEM 4/56B:18	GN	Junction point 53/353	GN
8	CEM 4/56C:6	BN-W	Connector 54/8:2	BN-W
9	CEM 4/56A:4	Y	Connector 54/4:3	Y
10	CEM 4/56B:15	Y	Windshield washer pump 6/2:3	GN-Y
11	CEM 4/56A:9	GN-R	LH headlight level adjustment motor 6/38:2 RH headlight adjustment motor 6/39:2	GN-R
12	CEM 4/56B:4	Y	Junction point 53/365	Y
13	Fuse 11C/12:2	VO	Junction point 53/380	VO

54/3LH 2-pole black

Passenger compartment harness - Engine compartment harness

No.	Passenger compartment harness		Engine compartment harness	
1	Junction point 53/415	R	Main fuses in fusebox 11A/2:2	R-SB
2	-	-	-	-

54/4 4-pole dark gray

Measure front - Measure the engine compartment

No.	Front harness		Engine compartment harness	
1	Horn 1 16/10:1	R-SB	Horn relay 2/17:5	R-SB
2	Horn 2 16/11:1	R-SB	Horn relay 2/17:5	R-SB
3	Hood alarm contact 3/62:1	Y	Connector 54/3LG:9	Y
4	Junction point 53/382	SB	Junction point 53/331	GR-SB

54/8 2-pole dark gray
Engine compartment harness - Front harness

No.	Engine compartment harness		Front harness	
1	Fuse 11B/2:2	R-SB	Junction point 53/343	R
2	Connector 54/3LG:8	BN-W	Auxiliary light (accessory) relay 2/64:1	BN-W

54/9 6-pole dark gray
Engine compartment harness - Front harness

No.	Engine compartment harness		Front harness	
1	Connecting rail	-	Control unit CPM 4/7:9	R
2	-	-	-	-
3	Junction point 53/331	-	-	-
4	Connector 54/3LF:12		Control unit CPM 4/7:15	VO-W
5	-	-	-	-
6	Connector 54/3LF:13	-	Control unit CPM 4/7:6	GN-W

54/10 12-pole black
Passenger compartment harness - LH front door harness

No.	Passenger compartment harness		LH front door harness	
1	Fuse 11C/35:2	R	Control unit left front door DDM/PDM 3/126B:12	R
2	Fuse 11C/27:2	R-W	Control unit left front door DDM/PDM 3/126B:7	R-W
3	Junction point 53/516	W	Control unit left front door DDM/PDM 3/126A:2	W
4	Junction point 53/517	GN	Control unit left front door DDM/PDM 3/126A:3	GN
5	Connector 54/3LC:3	W	LH power door mirror 6/62:2	W
6	Connector 54/3LC:2	BN	LH power door mirror 6/62:3	BN
7	-	-	-	-
8	CEM 4/56D:7	P	LH front door lock unit 3/74:3	P
9	Radio 16/1B:1 Connector 54/14:1	GR-R	Junction point 53/519	GR-R
10	Radio 16/1B:2 Connector 54/14:2	GR	Junction point 53/520	GR
11	Junction point 53/500	SB	Control unit left front door DDM/PDM 3/126B:5	SB
12	Junction point 53/510 LHD Ground connection 31/66	BN	Control unit left front door DDM/PDM 3/126B:9	BN

Connector

54/11 - 54/12

54/11 12-pole black

Passenger compartment harness - RH front door harness

No.	Passenger compartment harness		RH front door harness	
1	Fuse 11C/36:2	R	Control unit right front door PDM/DDM 3/127B:12	R
2	Fuse 11C/27:2	R-W	Control unit right front door PDM/DDM 3/127B:7	R-W
3	Junction point 53/433	W	Control unit right front door PDM/DDM 3/127A:2	W
4	Junction point 53/434	GN	Control unit right front door PDM/DDM 3/127A:3	GN
5	-	-	-	-
6	-	-	-	-
7	-	-	-	-
8	CEM 4/56D:8	P	RH front door lock unit 3/75:3	P
9	Radio 16/1B:5 Connector 54/14:5	GR-R	Junction point 53/521	GR-R
10	Radio 16/1B:6 Connector 54/14:6	GR	Junction point 53/522	GR
11	Junction point 53/501	SB	Control unit right front door PDM/DDM 3/127B:5	SB
12	Ground connection 31/67	BN	Control unit right front door PDM/DDM 3/127B:9	BN

54/12 4-pole orange

Passenger compartment harness - Airbag SRS harness

No.	Passenger compartment harness		Airbag SRS harness	
1	Control unit SRS 4/9B:12	OR	Passenger side airbag 8/31:1	BL
2	Control unit SRS 4/9B:11	OR-SB	Passenger side airbag 8/31:2	BN
3	Control unit SRS 4/9B:14	GN-OR	Passenger side airbag, step 2 8/32:2	BN
4	Control unit SRS 4/9B:13	OR	Passenger side airbag, step 2 8/32:1	BL

**54/13 22-pole black
Passenger compartment harness - Roof harness**

No.	Passenger compartment harness		Roof harness	
1	Fuse 11C/28:2	R	Junction point 53/534	R
2	-	-	-	-
3	-	-	-	-
4	-	-	-	-
5	Junction point 53/516	W	Upper Electronic Module UEM 4/70:3	W
6	Junction point 53/517	GN	Upper Electronic Module UEM 4/70:5	GN
7	-	-	-	-
8	Mobile telephone 16/60:1	W	Connector 54/15:1	W
9	-	-	-	-
10	-	-	-	-
11	CEM 4/56B:5	Y-R	Auxiliary brake light 10/19:1	Y-R
12	-	-	-	-
13	-	-	-	-
14	Connector 54/3LF:8	W	-	-
15	Connector 54/3LG:5	P	Upper Electronic Module UEM 4/70:21 Control unit SRM 4/33:4	P
16	CEM 4/56A:15	Y	Connector 54/16:4	W
17	Connector 54/43A:12	P	-	-
18	Mobile telephone 16/60:11	Fender	Connector 54/15:2	Fender
19	-	-	-	-
20	Junction point 53/400	BN	Junction point 53/503	BN
21	Fuse 11C/34:2	R	Control unit SRM 4/33:1	R
22	Junction point 53/405	SB	Control unit SRM 4/33:10	SB

Connector

54/14 - 54/16

54/14 12-pole light gray

Passenger compartment harness - Audio harness

No.	Passenger compartment harness		Audio harness	
1	Connector 54/10:9	GR-R	Amplifier 16/2B:1	GR-R
2	Connector 54/10:10	GR	Amplifier 16/2B:2	GR
3	-	-	-	-
4	-	-	-	-
5	Connector 54/11:9	GR-R	Amplifier 16/2B:5	GR-R
6	Connector 54/11:10	GR	Amplifier 16/2B:6	GR
7	Junction point 53/523	GR-W	Amplifier 16/2B:7	GR-W
8	Junction point 53/524	GR	Amplifier 16/2B:8	GR
9	-	-	-	-
10	-	-	-	-
11	Junction point 53/525	GR-W	Amplifier 16/2B:11	GR-W
12	Junction point 53/526	GR	Amplifier 16/2B:12	GR

54/15 2-pole light gray

Roof harness - Microphone

No.	Roof harness		Microphone	
1	Connector 54/13:8	W	Microphone, mobile telephone 16/77	W
2	Connector 54/13:18	Fender	Microphone, mobile telephone 16/77	Fender

54/16 5-pole green

Roof harness - Rain sensor harness

No.	Roof harness		Rain sensor harness	
1	Upper Electronic Module UEM 4/70:13	W	Rain sensor 7/149:1	GN
2	Junction point 53/503	BN	Rain sensor 7/149:2	BN
3	Junction point 53/505	VO-W	Rain sensor 7/149:3	VO-W
4	Connector 54/13:16	W	Rain sensor 7/149:4	BN
5	-	-	-	-

54/20 12-pole black

Passenger compartment harness - LH rear door harness

No.	Passenger compartment harness		LH rear door harness	
1	Junction point 53/523	GR-W	LH rear door speaker 16/6:1	GR-W
2	Junction point 53/524	GR	LH rear door speaker 16/6:2	GR
3	CEM 4/56B:12	P	LH rear door lock unit 3/76:2	P
4	CEM 4/56B:13	BL	LH rear door lock unit 3/76:5	BL
5	Junction point 53/446	Y	LH rear door electric window switch 3/85:1 Junction point 53/527	Y
6	Rear left power window down relay 2/118:1	BL	LH rear door electric window switch 3/85:3	BL
7	Junction point 53/504	W	-	-
8	Rear left power window up relay 2/116:1	GN-BN	LH rear door electric window switch 3/85:5	GN-BN
9	Connector 54/40A:4	VO	LH rear door lock unit 3/76:8 Deadlock relay, LH rear door 2/138:1	VO
10	Connector 54/40A:3	GR	LH rear door lock unit 3/76:6	GR
11	Connector 54/40A:2	Y	LH rear door lock unit 3/76:4	Y
12	Junction point 53/500	SB	Junction point 53/531	SB

54/21 12-pole black

Passenger compartment harness - RH rear door harness

No.	Passenger compartment harness		RH rear door harness	
1	Junction point 53/525	GR-W	Speaker RH rear door 16/5:1	GR-W
2	Junction point 53/526	GR	Speaker RH rear door 16/5:2	GR
3	CEM 4/56C:18	P	RH rear door lock unit 3/77:2	P
4	CEM 4/56C:3	BL	RH rear door lock unit 3/77:5	BL
5	Junction point 53/446	Y	RH rear door electric window switch 3/86:1 Junction point 53/528	Y
6	Right rear power window down relay 2/119:1	BL	RH rear door electric window switch 3/86:3	BL
7	Junction point 53/504	W	-	-
8	Right rear power window up relay 2/117:1	GN-BN	RH rear door electric window switch 3/86:5	GN-BN
9	Connector 54/43:4	VO	RH rear door lock unit 3/77:8 Deadlock relay, RH rear door 2/139	VO
10	Connector 54/43:3	GR	RH rear door lock unit 3/77:6	GR
11	Connector 54/43:2	Y	RH rear door lock unit 3/77:4	Y
12	Junction point 53/501	SB	Junction point 53/532	SB

Connector

54/24 - 54/25

54/24 13-pole black

Passenger compartment harness - Front seat harness

No.	Passenger compartment harness		Front seat harness	
1	Fuse 11C/7:2	BL	LH seat heater control unit 4/201A:4	R
2	CEM 4/56B:1 1	Y-GR	LH seat heater control unit 4/201A:2	Y
3	Junction point 53/500	SB	LH seat heater control unit 4/201A:1	SB
4	Junction point 53/419	VO	Left seatbelt latch switch 3/93	VO
5	CEM 4/56B:9	OR-SB	Left seatbelt latch switch 3/93	OR-SB
6	-	-	-	-
7	Control unit SRS 4/9A:4	OR	Side airbag, LH front 8/51	BL
8	Control unit SRS 4/9A:3	BL-OR	LH front side airbag 8/51	BN
9	Mobile telephone 16/60:5 LHD	GR-R	Speaker, mobile telephone 16/78	GR-R
10	Mobile telephone 16/60:4 LHD	GR	Speaker, mobile telephone 16/78	GR
11	Fuse 11C/6:2 RHD	R	Power passenger seat module 3/27	GN-R
12	Junction Point 53/419 RHD	VO	Power passenger seat module 3/27	Y-R
13	Junction Point 53/501 RHD	SB	Power passenger seat module 3/27	SB

54/25 13-pole black

Passenger compartment harness - Front seat harness

No.	Passenger compartment harness		Front seat harness	
1	Fuse 11C/8:2	BL	RH seat heater control unit 4/202A:4	R
2	CEM 4/56C:4	Y-GR	RH seat heater control unit 4/202A:2	Y
3	Junction point 53/501	SB	RH seat heater control unit 4/202A:1	SB
4	Junction point 53/419	VO	Right seatbelt latch switch 3/94	VO
5	CEM 4/56C:2	OR-SB	Right seatbelt latch switch 3/94	OR-SB
6	-	-	-	-
7	Control unit SRS 4/9C:4	OR	RH front side airbag ignitor 8/52:1	BL
8	Control unit SRS 4/9C:3	BL-OR	RH front side airbag ignitor 8/52:2	BN
9	Mobil telephone 16/60:5 RHD	-	Speaker, mobile telephone 16/78	GR-R
10	Mobile telephone 16/60:4 RHD	-	Speaker, mobile telephone 16/78	GR
11	Fuse 11C/6:2 LHD	R	Power passenger seat module 3/27	GN-R
12	Junction point 53/419 LHD	VO	Power passenger seat module 3/27	Y-R
13	Junction point 53/501 LHD	SB	Power passenger seat module 3/27	SB

**Connector
54/40A - 54/40B**

54/40A 14-pole light gray

Baggage compartment harness - Passenger compartment harness

No.	Baggage compartment harness		Passenger compartment harness	
1	Shunt, parking light REM 20/28:3	W	Fuse 11C/30:2	W
2	Locking relay, LH rear 2/111:1	Y	Connector 54/20:11	Y
3	Unlocking relay, LH rear 2/112:1	GR	Connector 54/20:10	GR
4	Relay, deadlock, rear doors 2/115:1	VO	Connector 54/20:9	VO
5	REM 4/58A:16	GN	Junction point 53/435	GN
6	REM 4/58A:14	W	Junction point 53/436	W
7	-LH tail light housing 10/18A:2 -LH tail light housing 10/18B:4	GN	Turn signal shunt CEM left 20/32:2	GN
8	Junction point 53/609	GR	Fuse 11C/31:2	GR
9	-	-	Junction point 53/523	GR-W
10	-	-	Junction point 53/524	GR
11	REM 4/58A:2	GN	Fuel pump 6/33:5	GN
12	REM 4/58A:10 Junction point 53/608	BN	Fuel pump 6/33:6	BN
13	-	-	Fuel pump 6/33:7	BL
14	REM 4/58A:4	GN-Y	CEM 4/56B:6	GN-Y

54/40B 1-pole black

Passenger compartment harness - Baggage compartment harness

No.	Passenger compartment harness		Baggage compartment harness	
1	Window antenna amplifier, left 16/16:1	R	Relay, heated rear window 2/82:3	R

Connector

54/43A - 54/50

54/43A 14-pole light gray

Baggage compartment harness - Passenger compartment harness

No.	Baggage compartment harness		Passenger compartment harness	
1	-	-	-	-
2	Locking relay, RH rear 2/113:1	Y	Connector 54/21:11	Y
3	Unlocking relay, RH rear 2/114:1	GR	Connector 54/21:10	GR
4	Relay, deadlock, rear doors 2/115:1	VO	Connector 54/21:9	VO
7	RH rear lamp housing 10/17B:1,2,4	GN-W	RH turn signal shunt CEM 20/34	GN-W
8	REM 4/58F:3	BL	Fuse 11C20:2	BL
9	-	-	Junction point 53/525	GR-W
10	-	-	Junction point 53/526	GR
11	Connector 54/50:1	P	CEM 4/56C:5	P
12	-	-	Connector 54/13:17	P
13	-	-	-	-
14	-	-	-	-

54/50 10 -pole light gray

Baggage compartment harness - Trunk lid harness

No.	Baggage compartment harness		Trunk lid harness	
1	Connector 54/43A:11	p	Trunk lid/tailgate lock unit 3/78:1	BN-R
2	-	-	-	-
3	Trunk lid/tailgate opening relay 2/67:1	GR-W	Trunk lid lock unit 3/78:2	GR-W
4	-	-	License plate lighting 10/3:4	GR-GN
5	-	-	Trunk lid/tailgate lock unit 3/78:3	BN
7	Junction point 53/609	GR	License plate lighting 10/3:2	GR
8	REM 4/58D:7	BL	License plate lighting 10/3:1	BL-BN
9	-	-	-	-
10	Junction point 53/601	SB	Trunk lid/tailgate lock unit 3/78:4	BL-SB

54/51 13-pole light gray
Towing bracket wiring - Baggage compartment harness

No.	Towing bracket wiring		Baggage compartment harness	
1	15-Feed	BL	Fuse 11D/15:2	BL
2	30-Feed	R	Fuse 11D/9:2	R
4	Brake lights	Y	Brake light relay 2/79:1	Y
5	Rear fog light	P	Relay fog light 2/83:1	P
7	Ground connection	SB	Ground connection 31/73	SB
8	RH parking light	GR	Junction point 53/609	GR
9	RH turn signal	GN-W	RH rear lamp housing 10/17B:4 RH rear lamp housing 10/17A:2	GN-W
10	LH turn signal	GN	LH tail light housing 10/18B:4 LH tail light housing 10/18A:2	GN
11	LH parking light	W	Shunt, parking light REM 20/28:3	W
12	Reversing lights	BL	Junction point 53/615	BL

54/53 Turbo, 4-pole black
Engine harness - Knock sensor

No.	Engine harness		Knock sensor	
1	Engine Control Module ECM 4/46A:46	BN-SB	Front knock sensor 7/24	BN
2	Engine Control Module ECM 4/46A:64	SB	Front knock sensor 7/24	SB
3	Engine Control Module ECM 4/46A:45	BN	Rear knock sensor 7/23	BN
4	Engine Control Module ECM 4/46A:67	Y-SB	Rear knock sensor 7/23	SB

Connector

54/53 - 54/56

54/53 Non-turbo, 4-pole dark gray
Engine harness - Knock sensor

No.	Engine harness		Knock sensor	
1	Engine Control Module ECM 4/46A:46	BN	Front knock sensor 7/24	BN
2	Junction point 53/318	SB	Front knock sensor 7/24	SB
3	Engine Control Module ECM 4/46A:45	BN	Rear knock sensor 7/23	BN
4	Junction point 53/318	BN-GR	Rear knock sensor 7/23	SB

54/55 RHD 3-pole dark gray
Engine compartment harness - Brake pressure sensor

No.	Engine compartment harness		Brake pressure sensor	
1	ABS control module 4/16:28	GN-BN	Brake pressure sensor 2 7/129:1	BN
2	ABS control module 4/16:12	GN-W	Brake pressure sensor 2 7/129:2	GN-W
3	ABS control module 4/16:43	GR-W	Brake pressure sensor 2 7/129:3	GR-W

54/56 RHD 3-pole dark gray
Engine compartment harness - Brake pressure sensor

No.	Engine compartment harness		Brake pressure sensor	
1	ABS control module 4/16:26	BL-BN	Brake pressure sensor 1 7/139:1	BN
2	ABS control module 4/16:10	OR-W	Brake pressure sensor 1 7/139:2	W
3	ABS control module 4/16:41	GR-OR	Brake pressure sensor 1 7/139:3	GR

Junction points 53/301 - 53/328

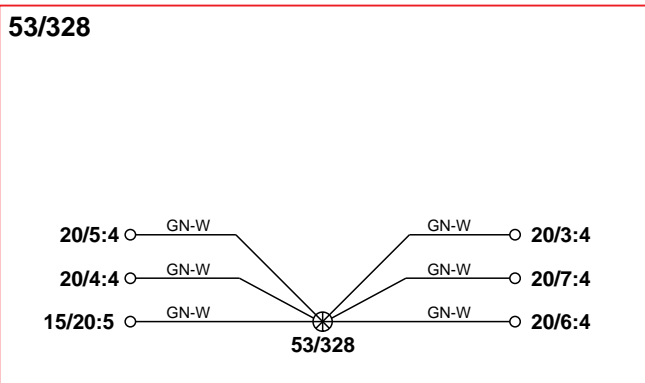
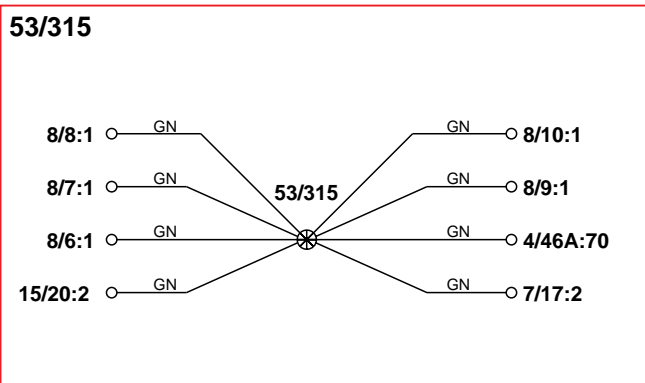
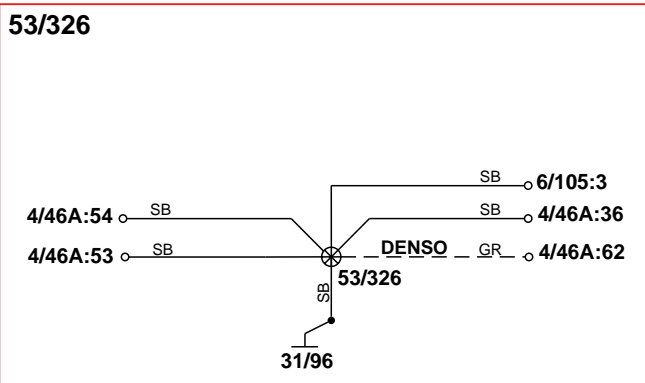
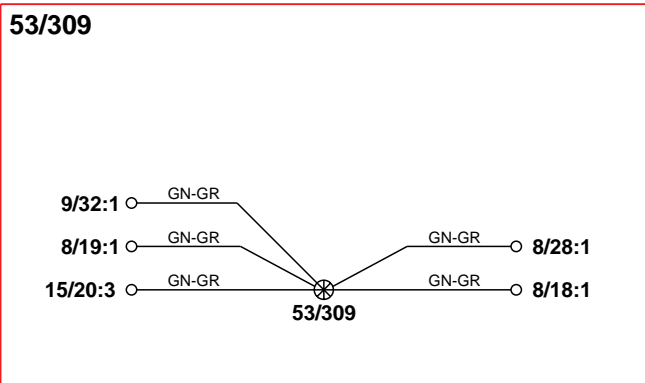
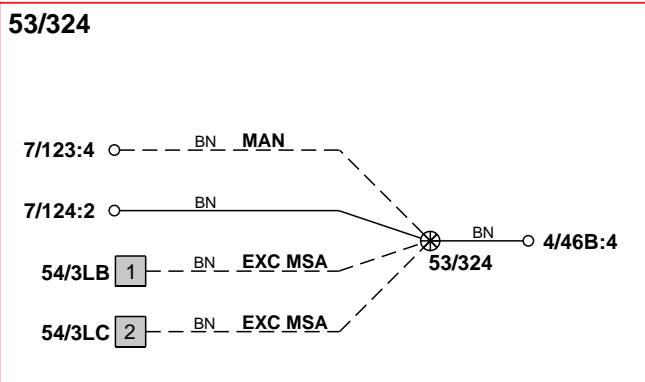
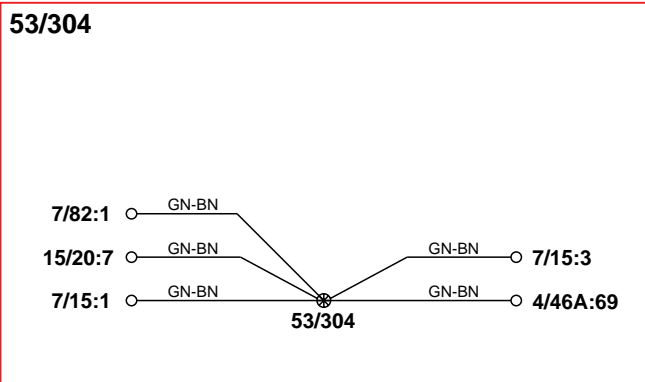
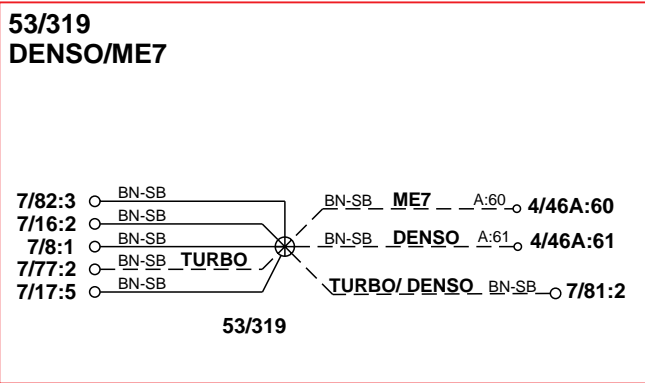
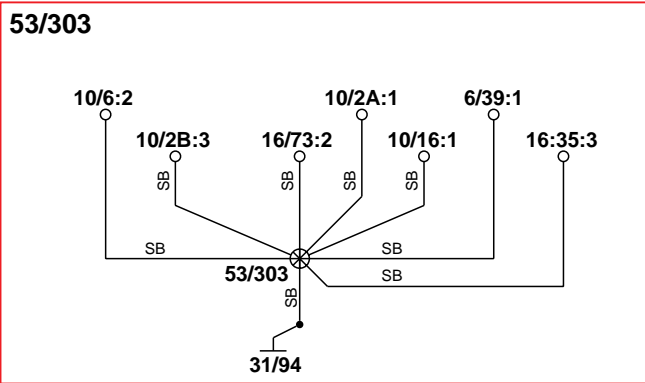
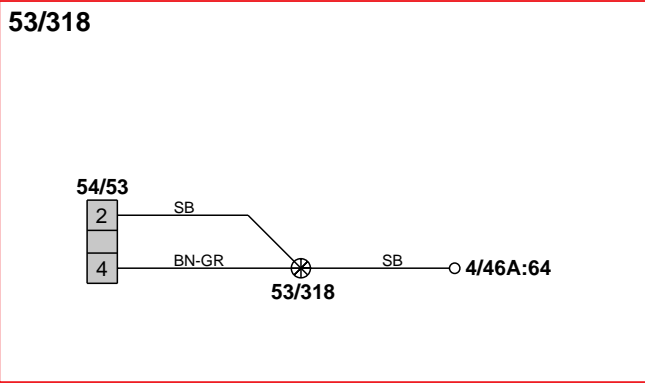
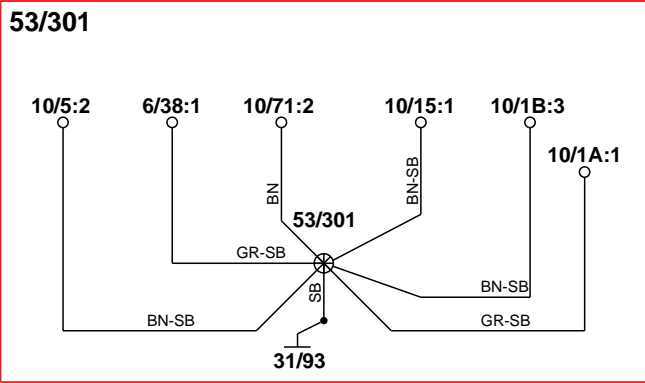

Junction points

53/329 - 53/360

53/329

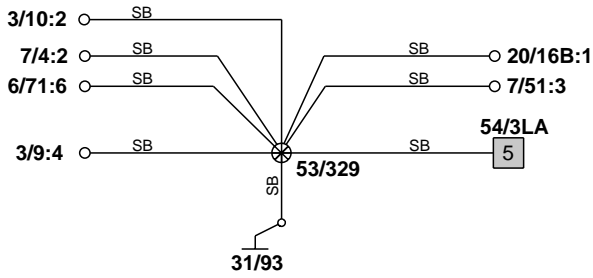

53/345

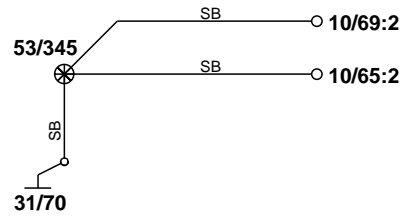

53/331

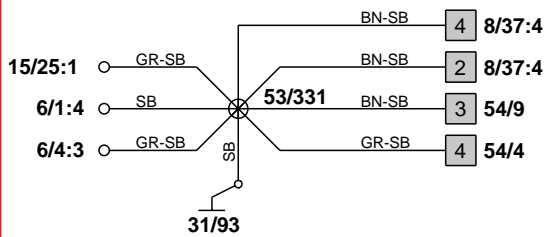

53/352

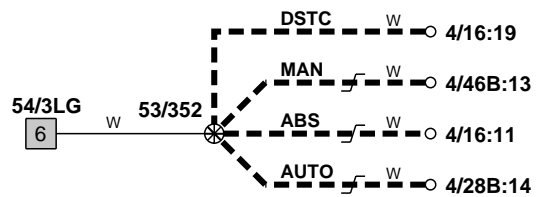

53/332
DENSO/ME7

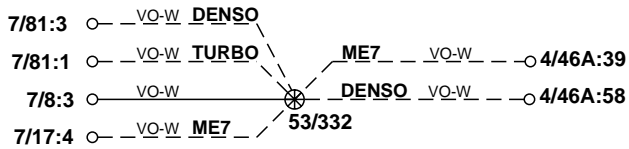

53/353

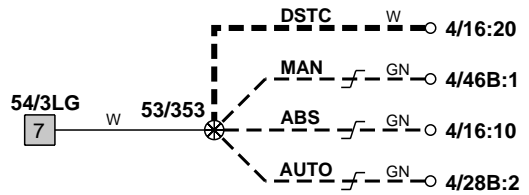

53/343

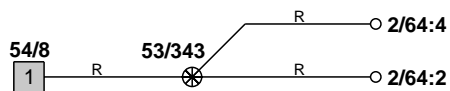

53/356

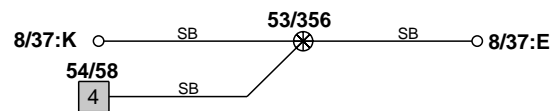

53/344

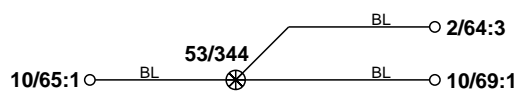

53/360
DENSO

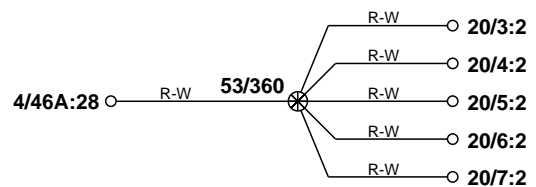

Junction points 53/365 - 53/403

53/365

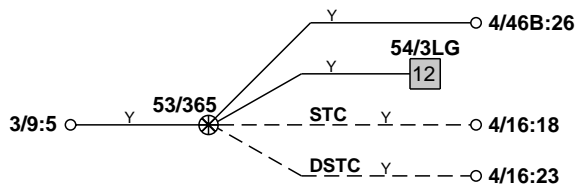

53/382

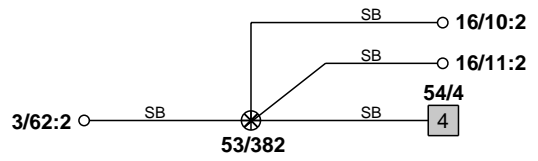

53/378

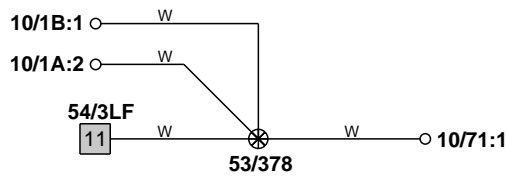

53/384

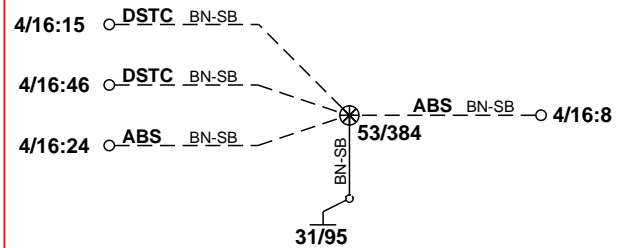

53/379

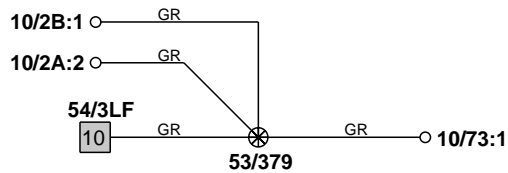

53/400

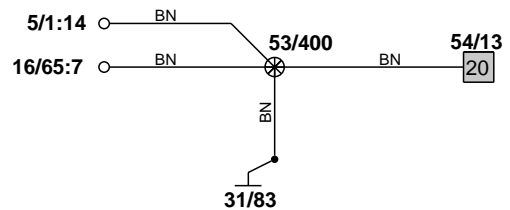

53/380

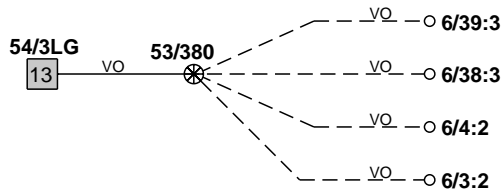

53/402

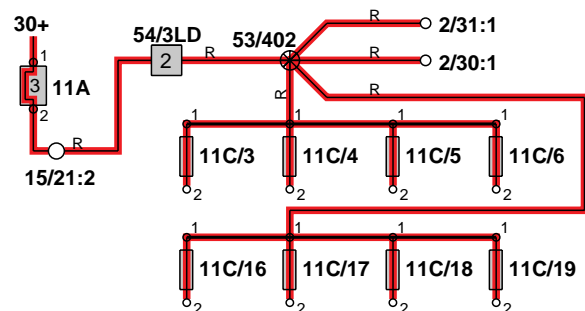

53/381

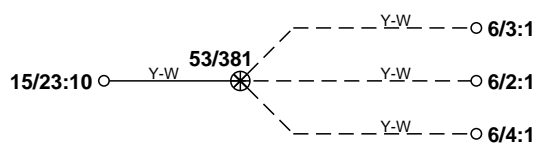

53/403

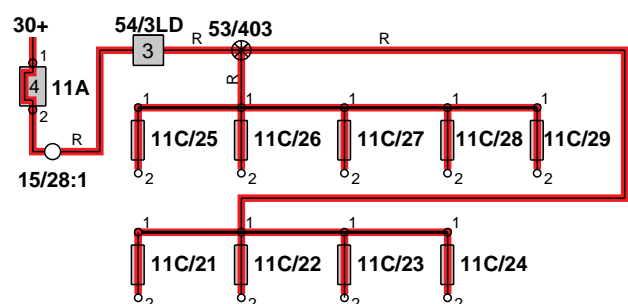

Junction points

53/405 - 53/430

53/405

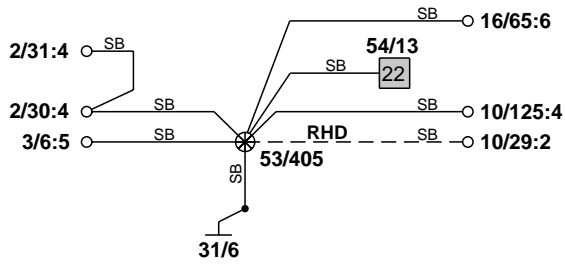

53/421

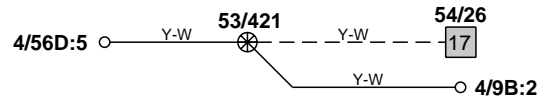

53/406

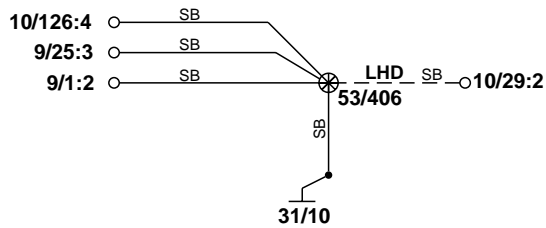

53/423

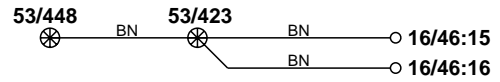

53/408

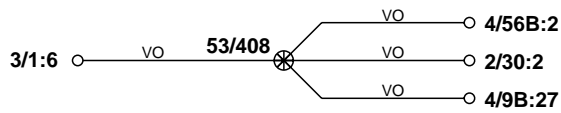

53/425

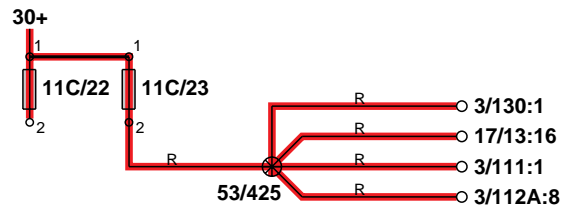

53/415

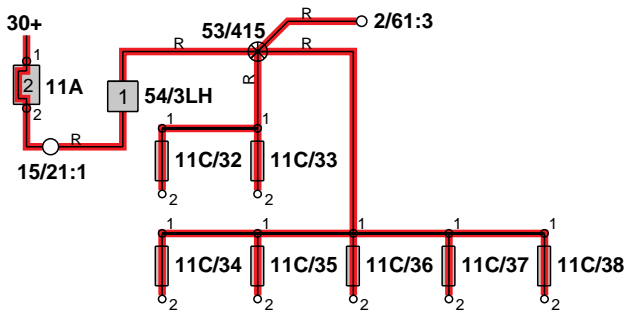

53/428

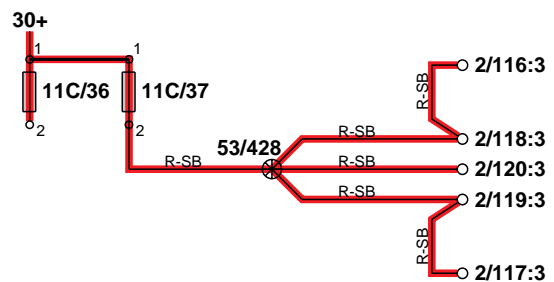

53/419

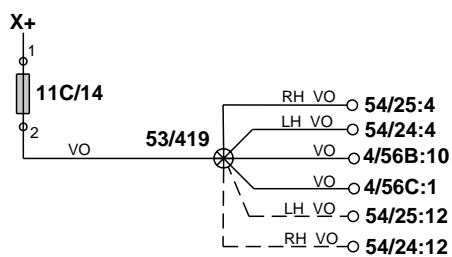

53/430

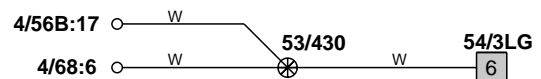

53/431

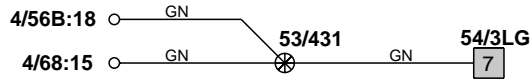

53/437

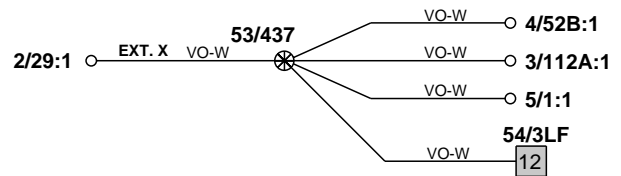

53/433

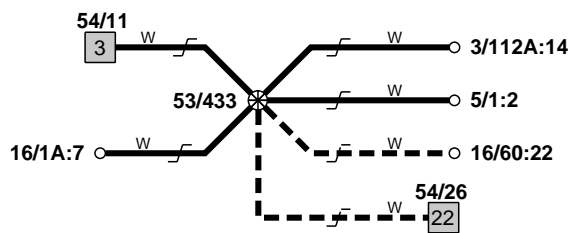

53/438

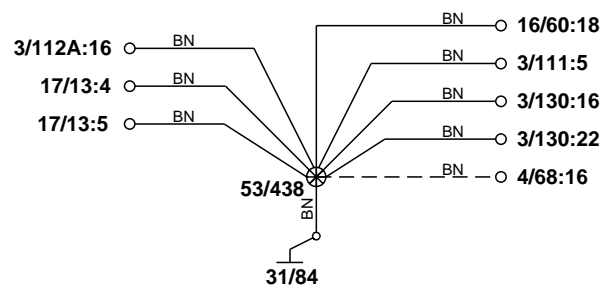

53/434

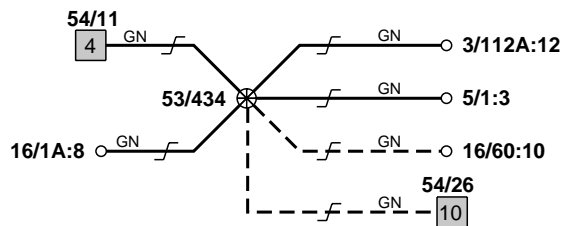

53/443

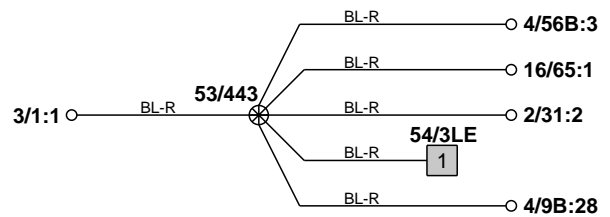

53/435

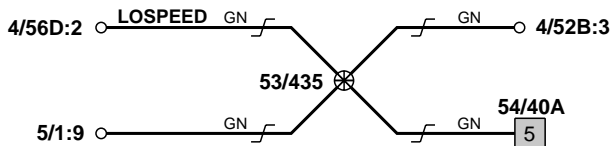

53/446

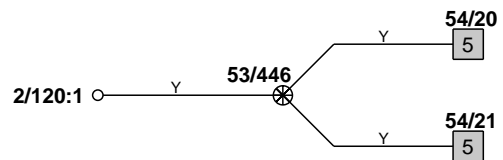

53/436

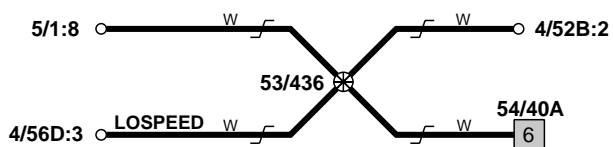

53/448

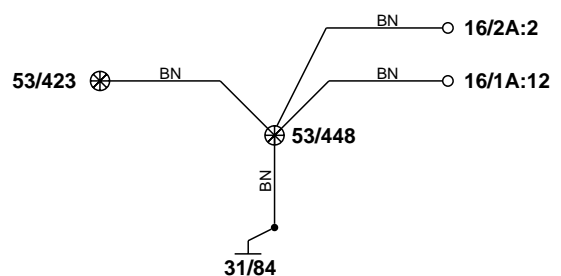

Junction points

53/500 - 53/519

53/500

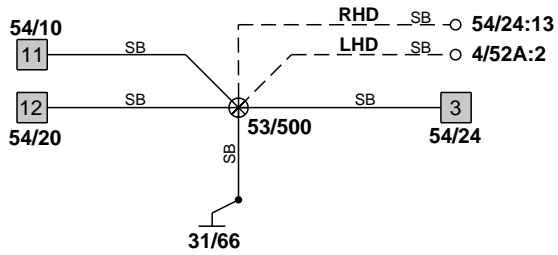

53/510 LHD

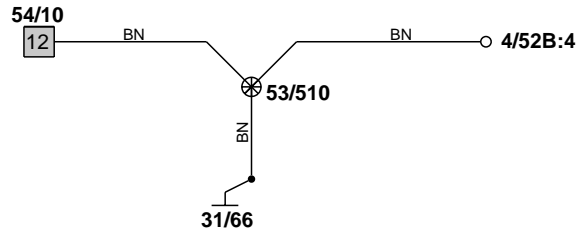

53/501

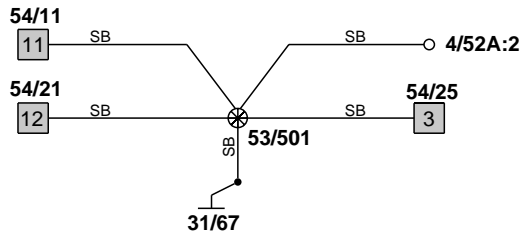

53/511 RHD

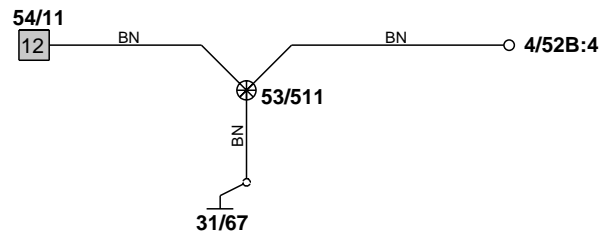

53/503

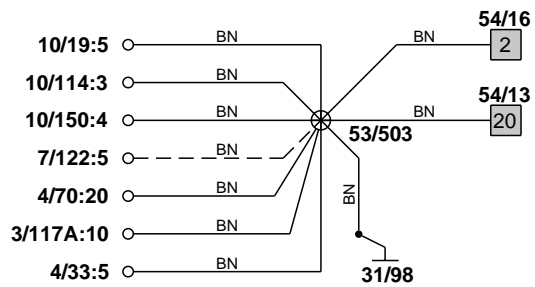

53/516

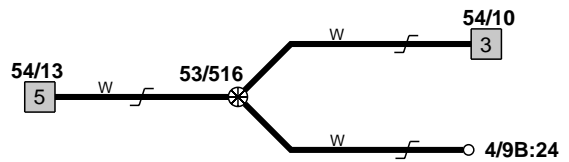

53/504

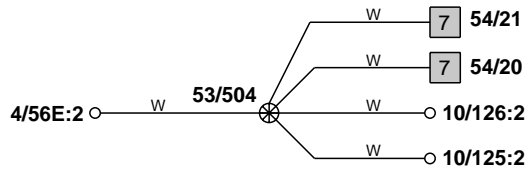

53/517

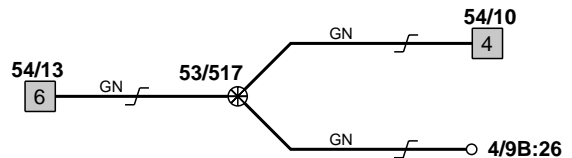

53/505

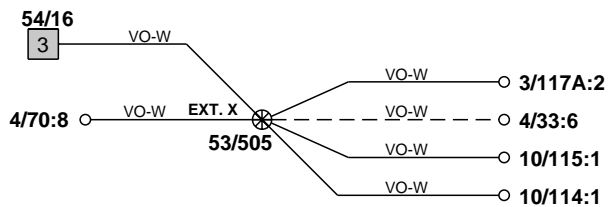

53/519

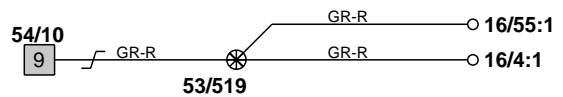

Junction points 53/520 - 53/531

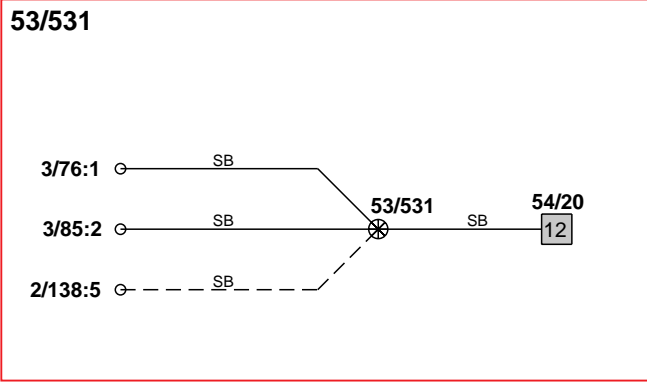
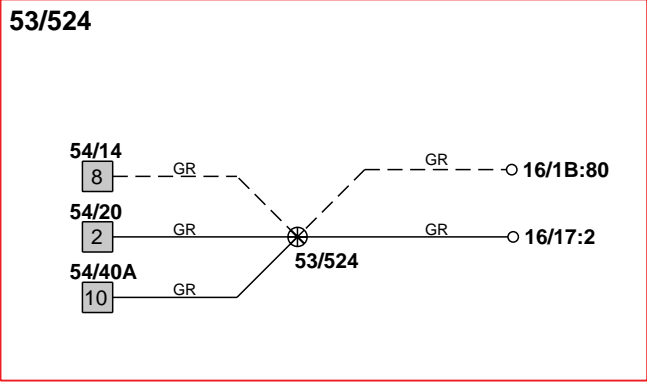
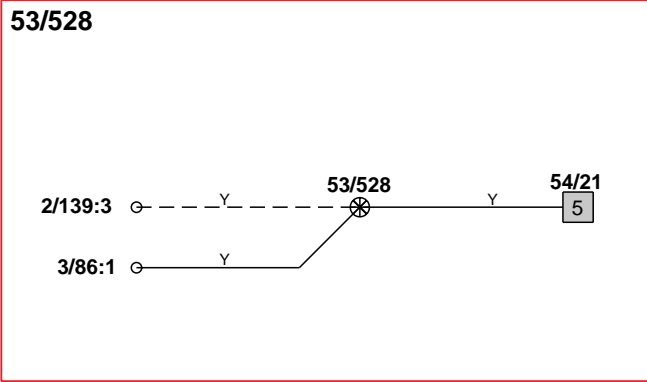
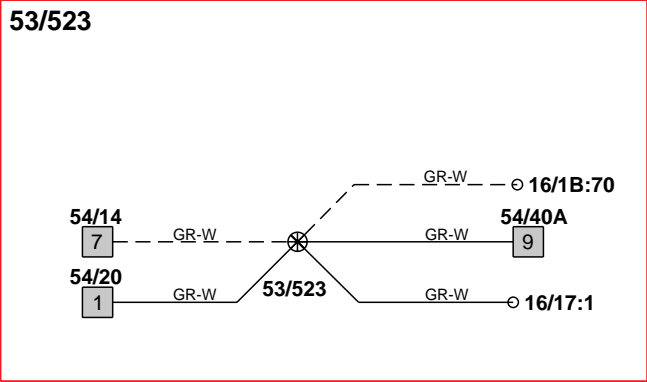
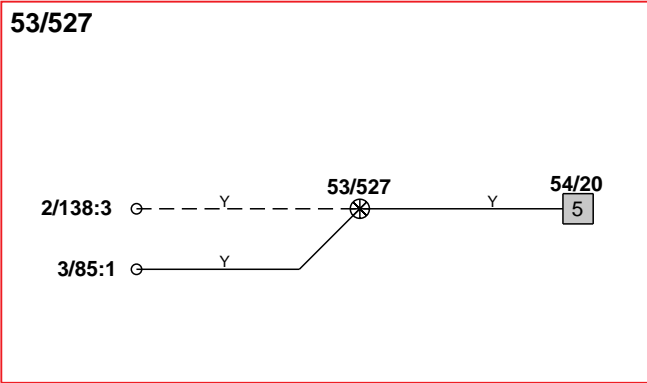
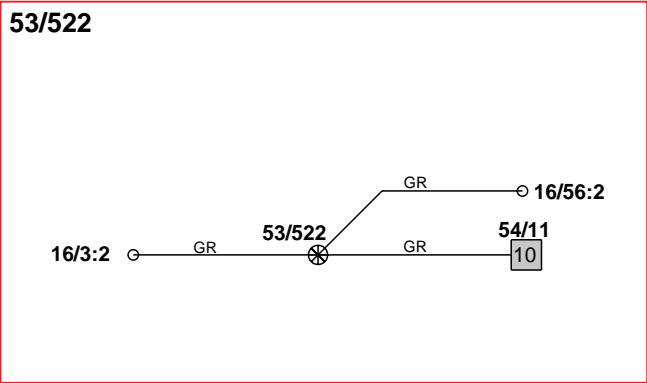
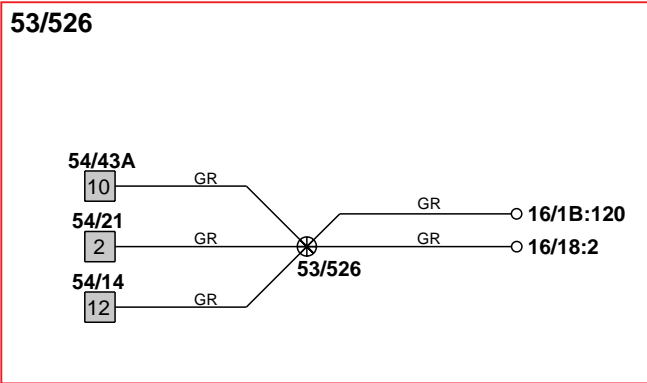
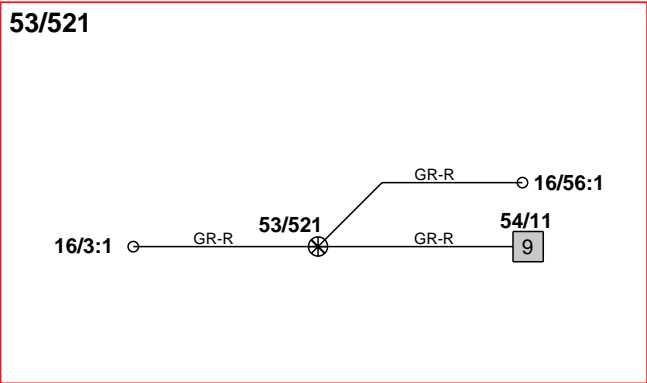
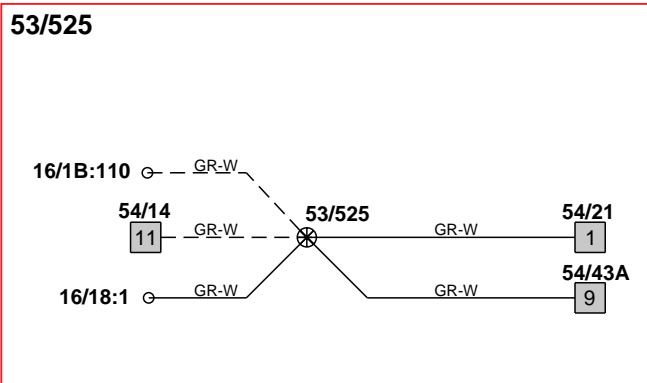
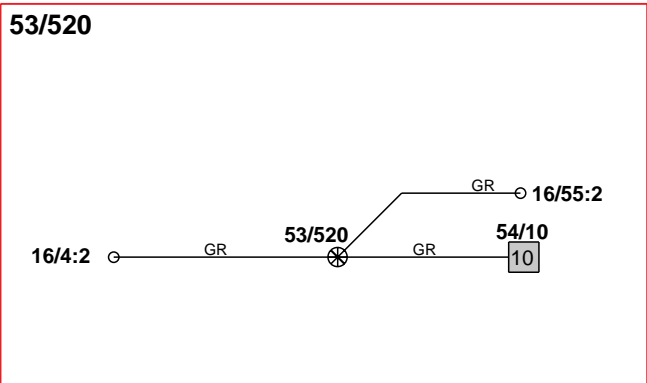

Junction points

53/532 - 53/625

53/532

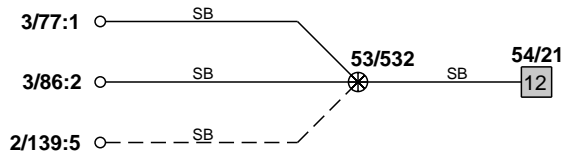

53/609

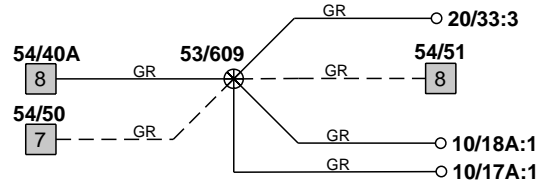

53/534

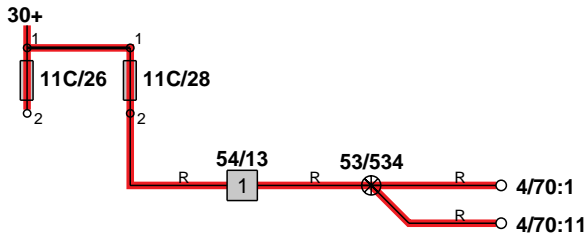

53/615

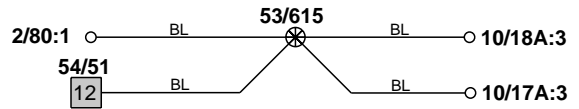

53/601

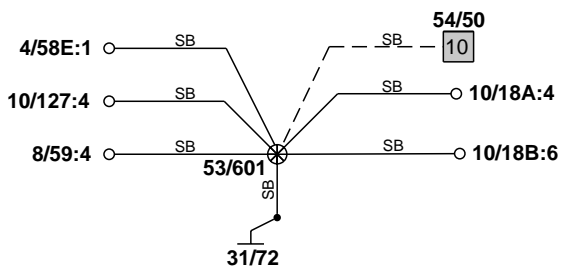

53/625

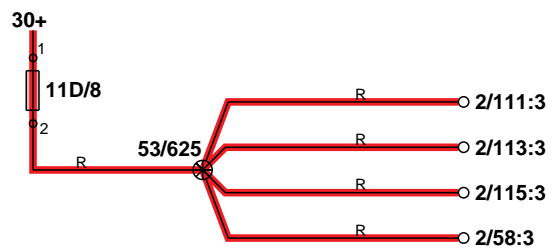

53/602

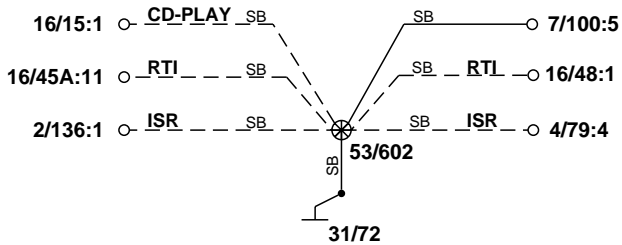

53/604

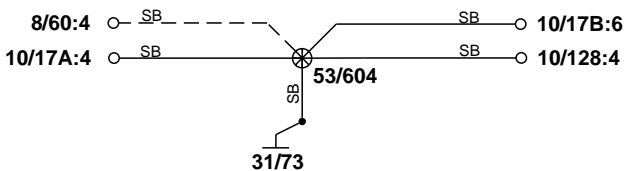

Cable harness routing in vehicle

Engine harness

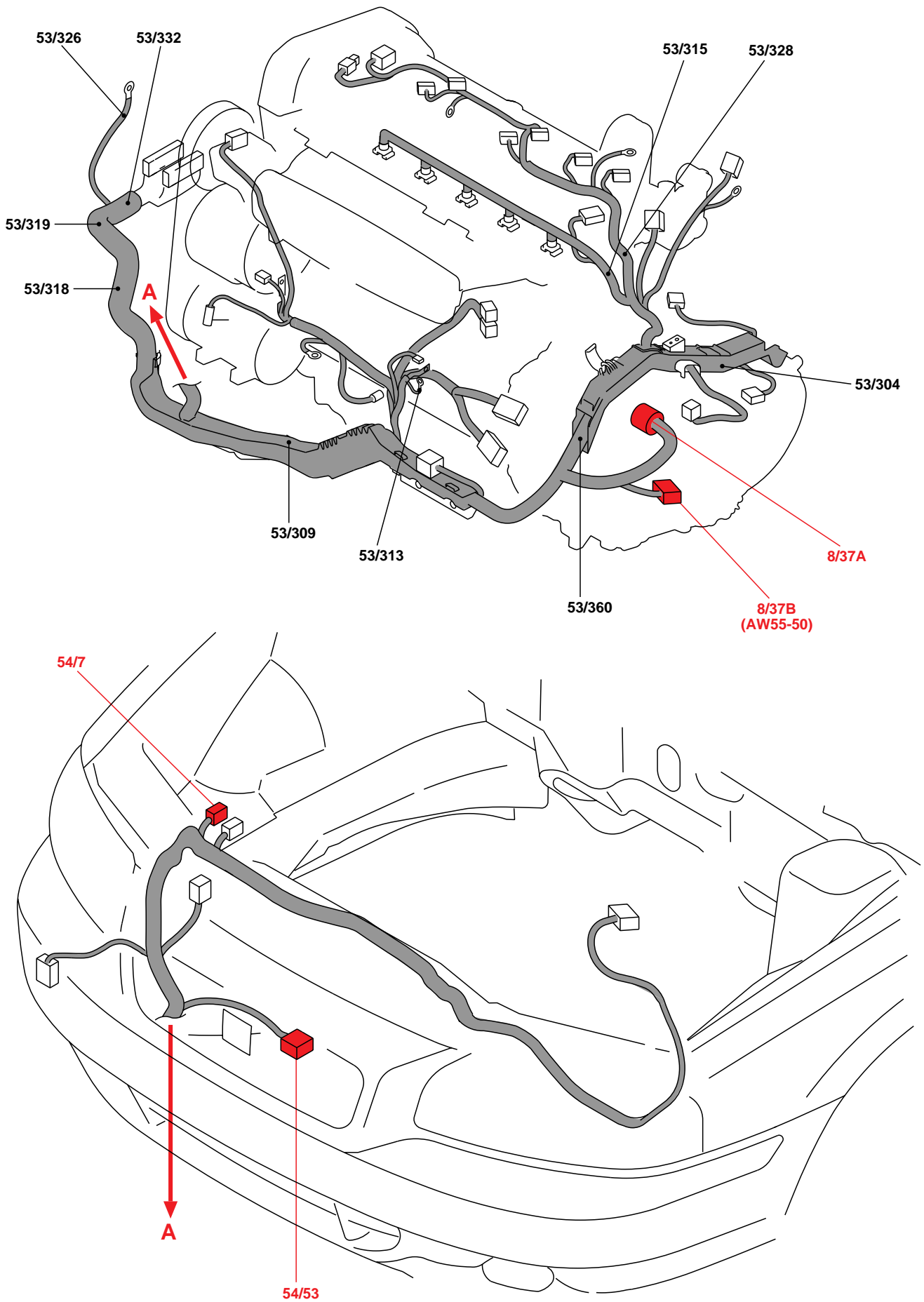

Cable harness routing in vehicle

Engine compartment harness LHD

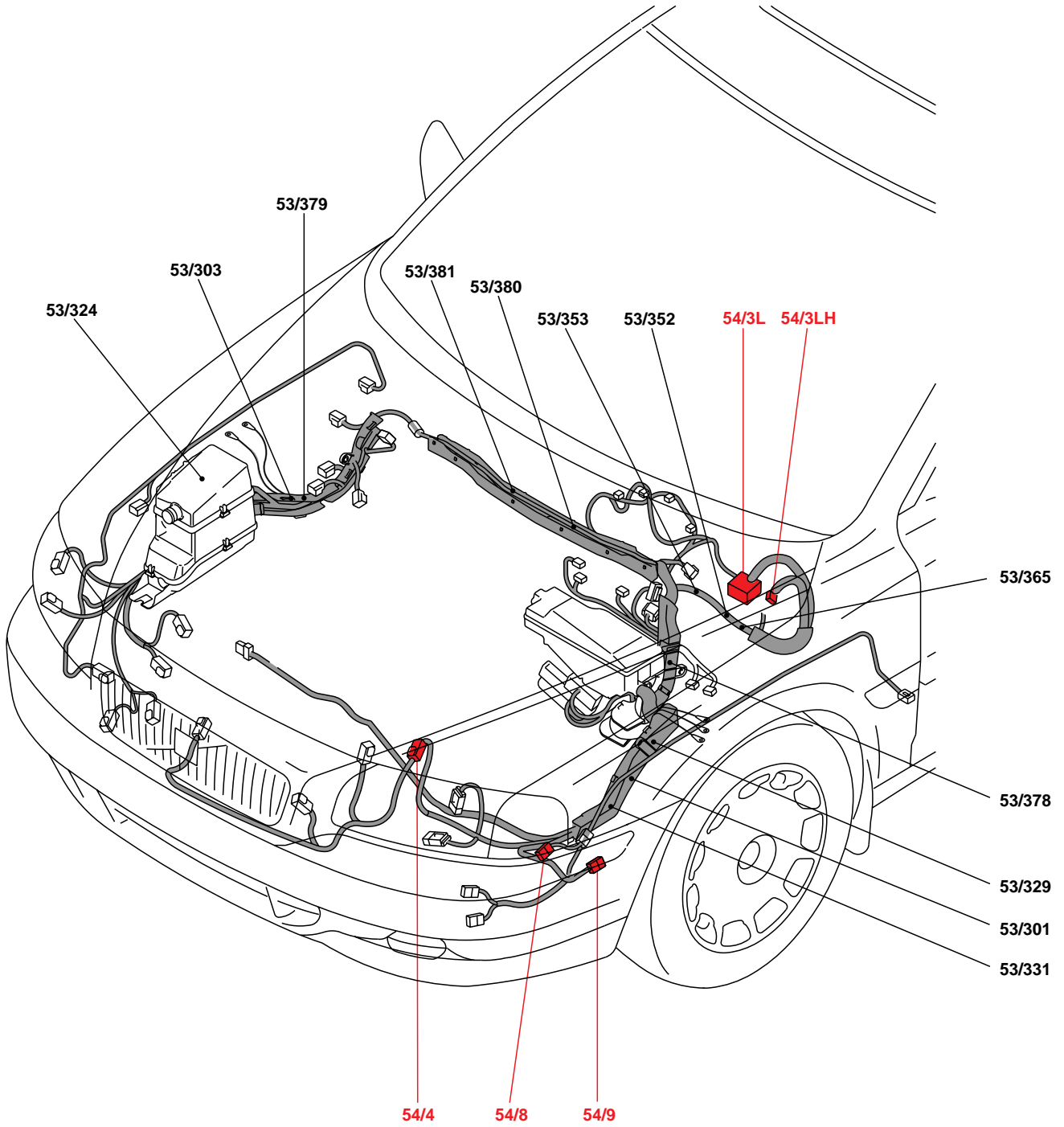

Cable harness routing in vehicle Engine compartment harness RHD

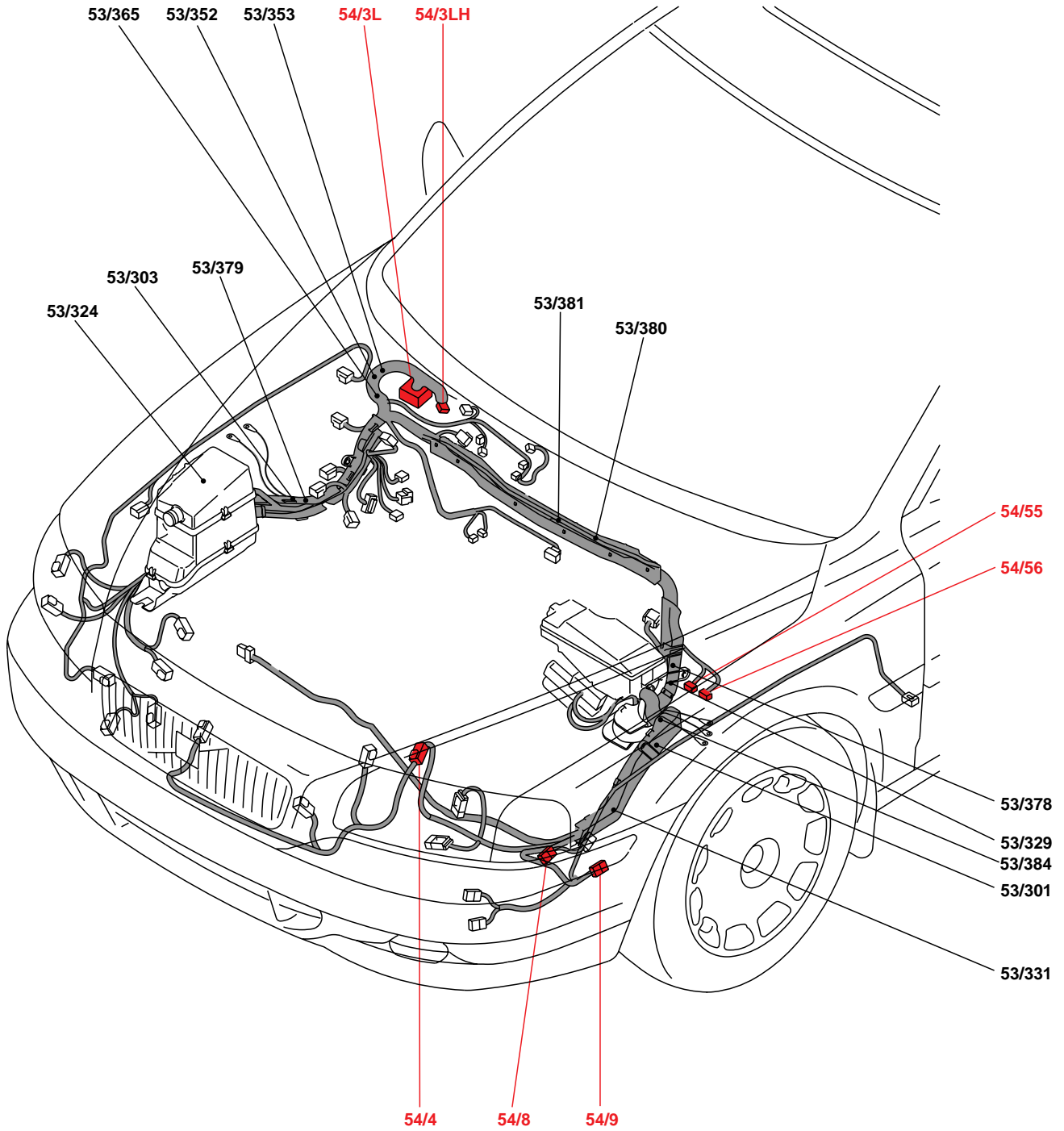

Cable harness routing in vehicle

Passenger compartment harness, front LHD

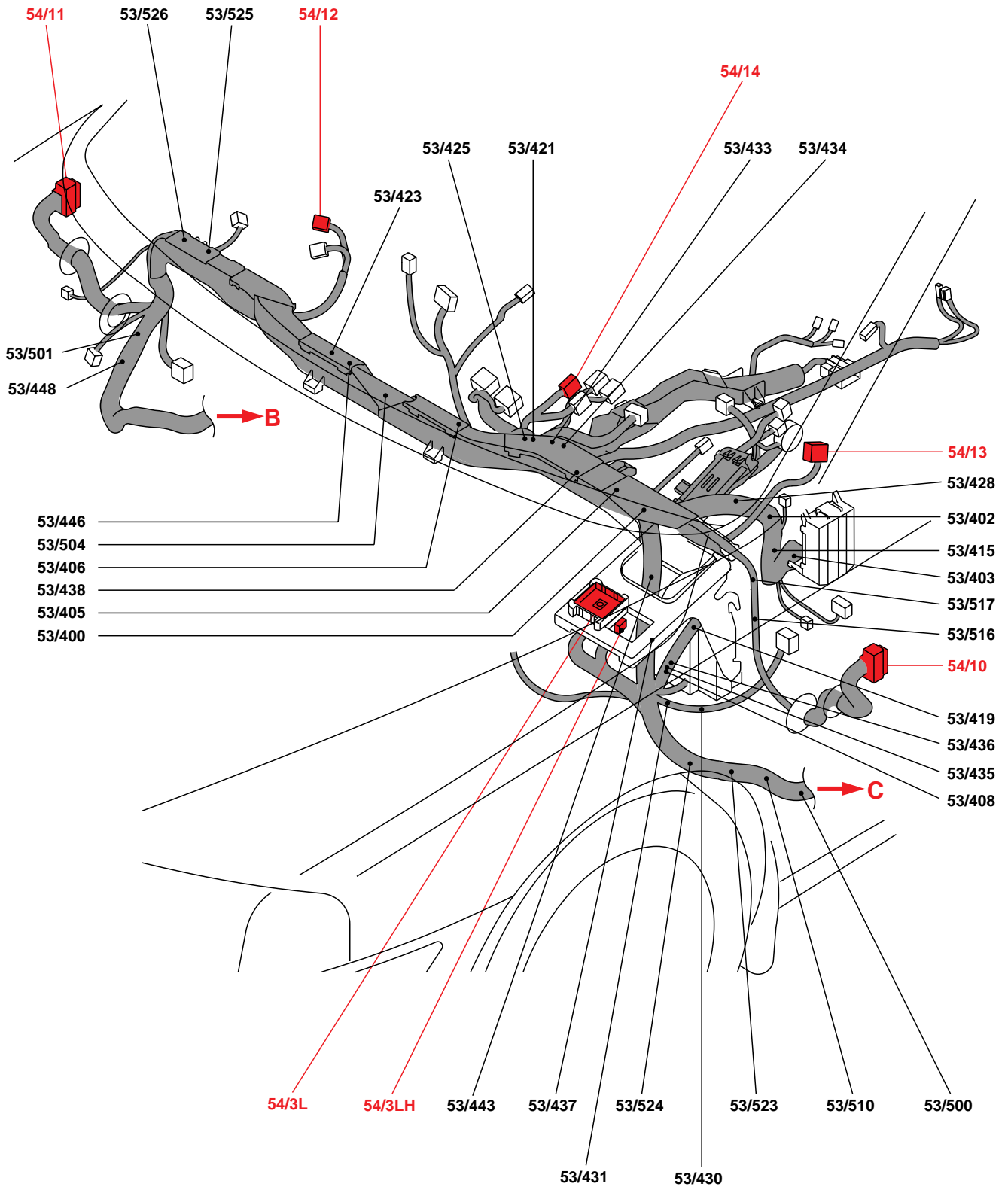

Cable harness routing in vehicle Passenger compartment harness, front RHD

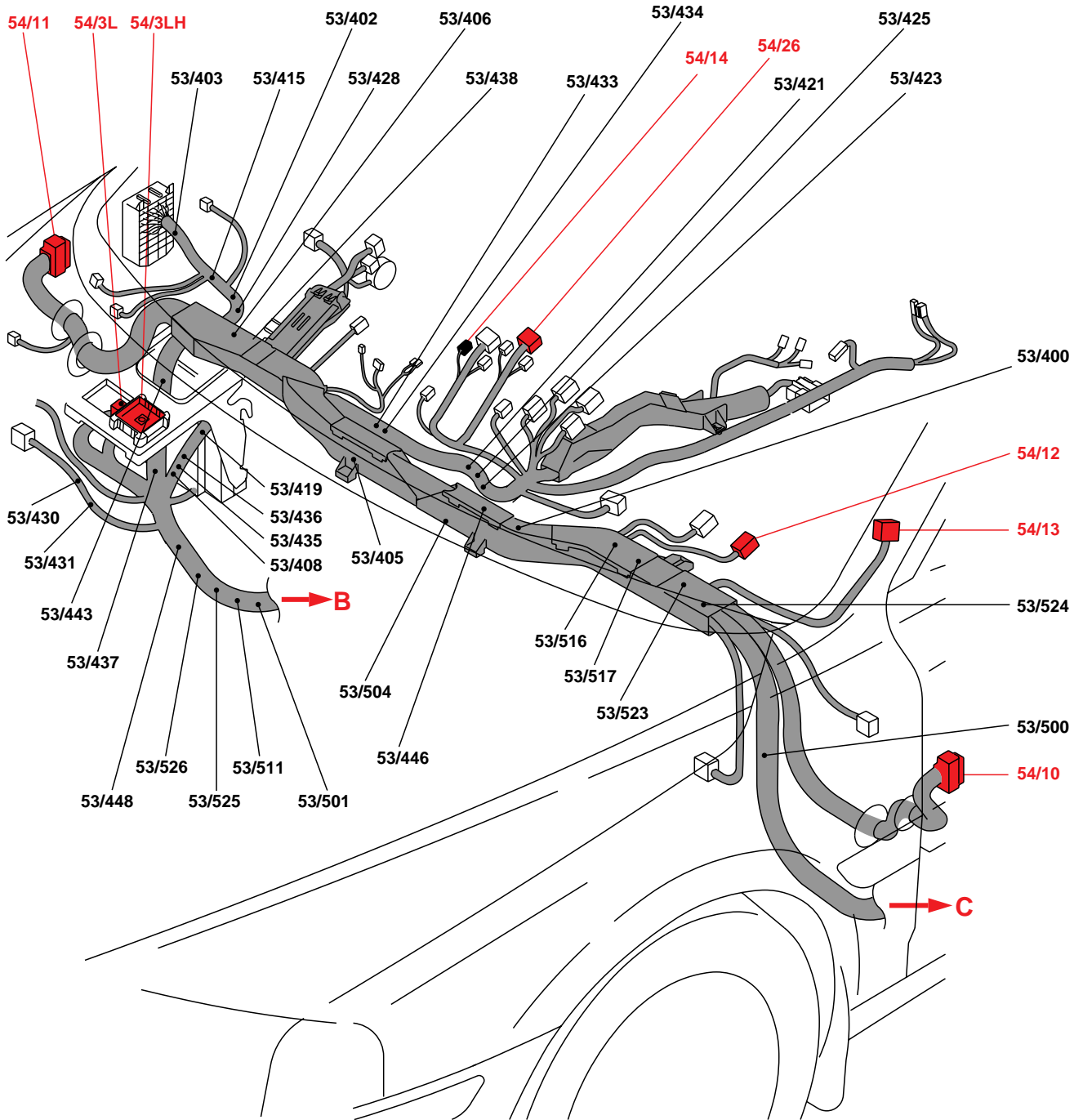

Cable harness routing in vehicle
Passenger compartment harness, rear

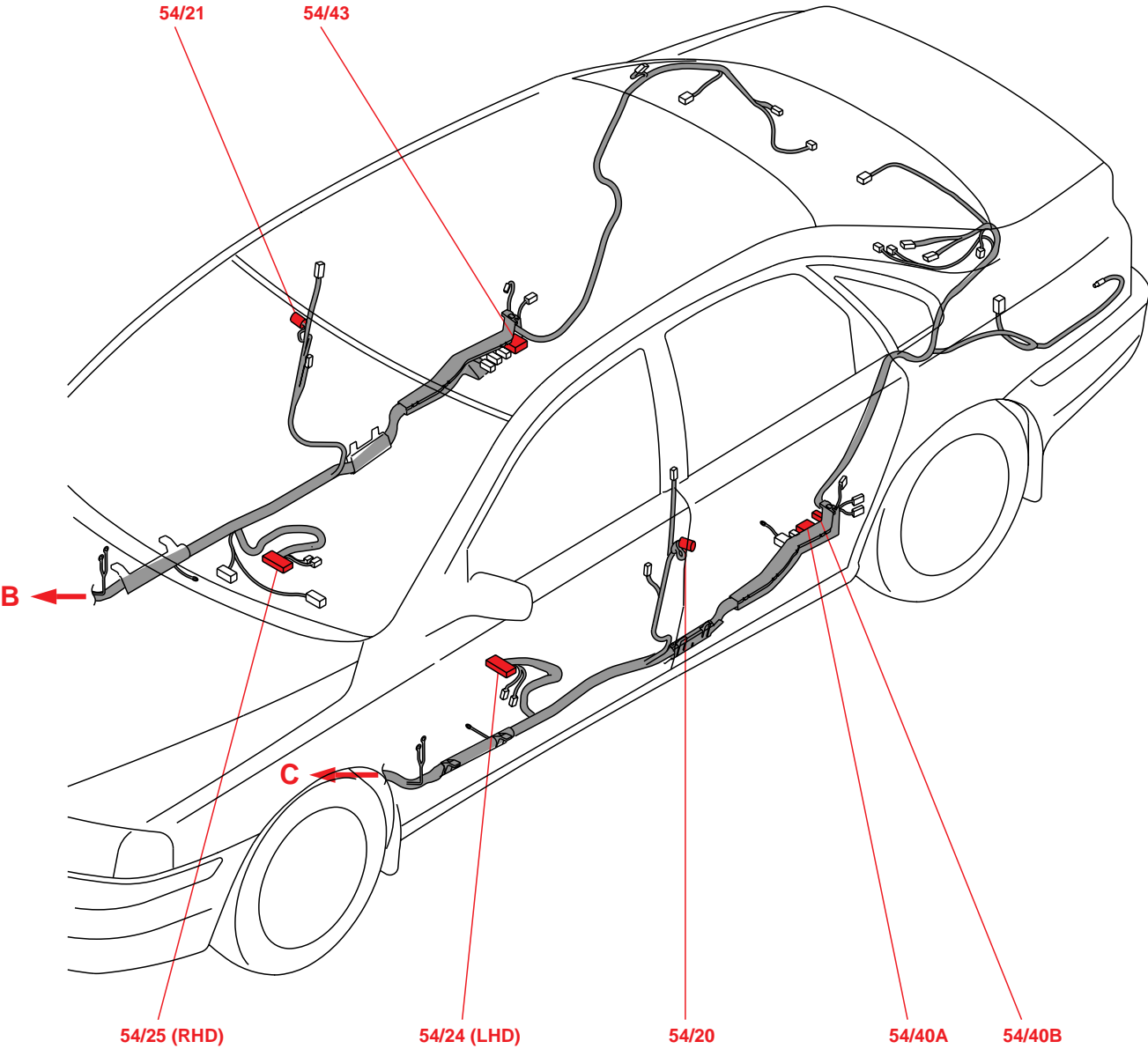

Cable harness routing in vehicle Baggage compartment harness

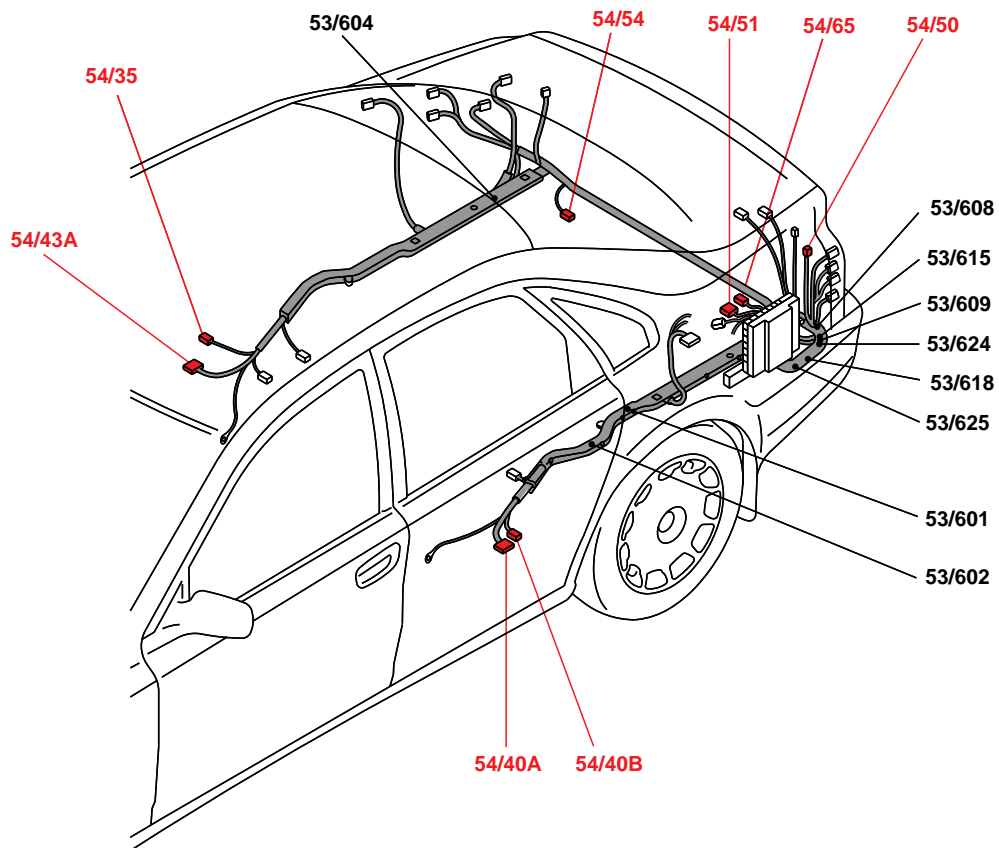

Cable harness routing in vehicle
Roof harness, trunk lid harness

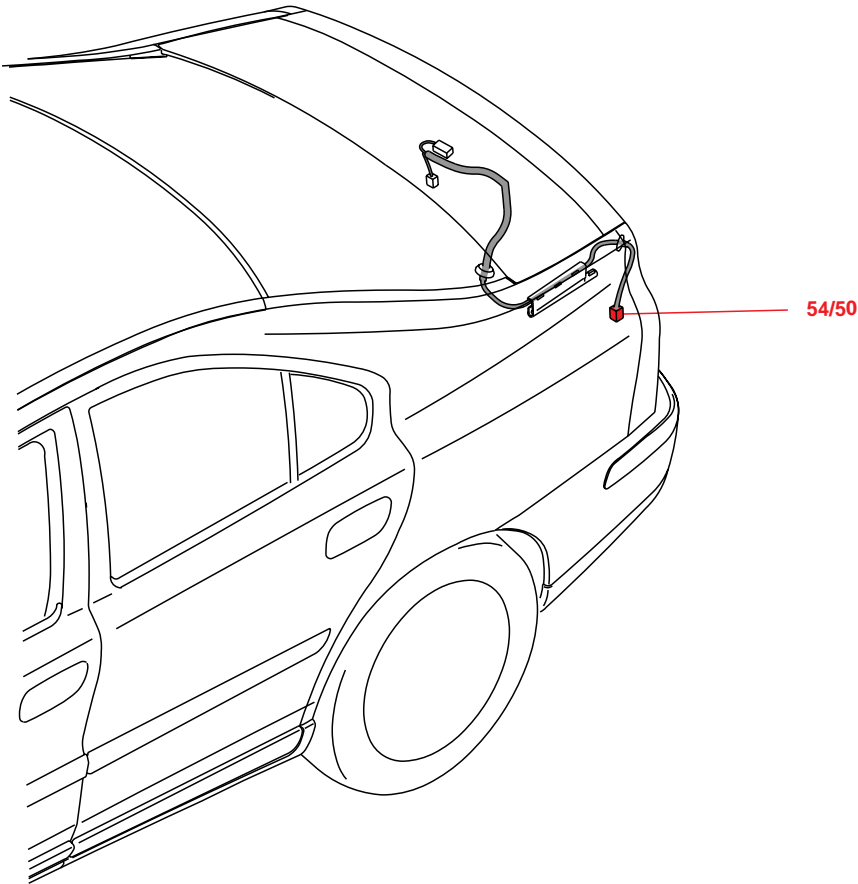
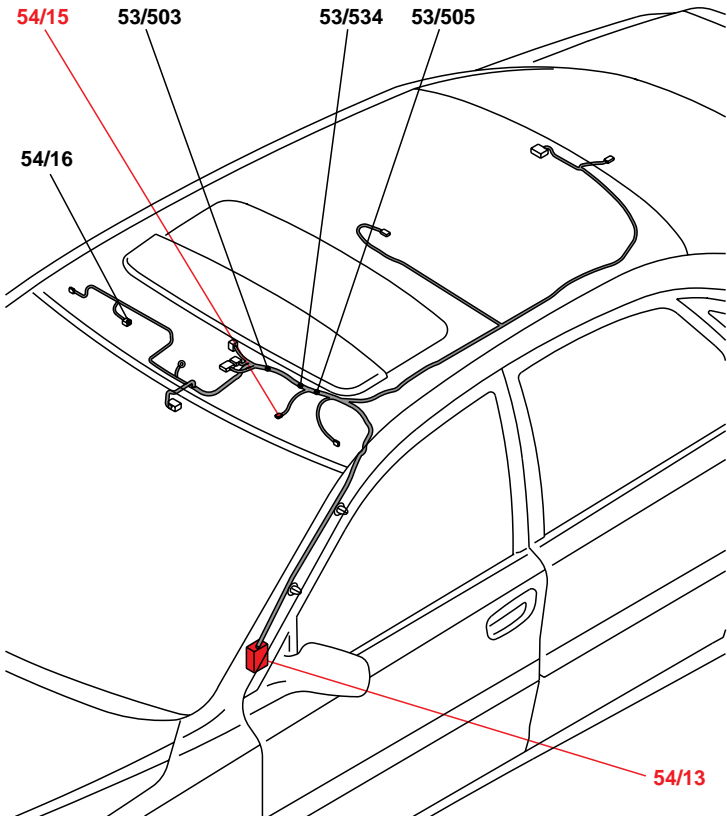

Cable harness routing in vehicle

Door harness

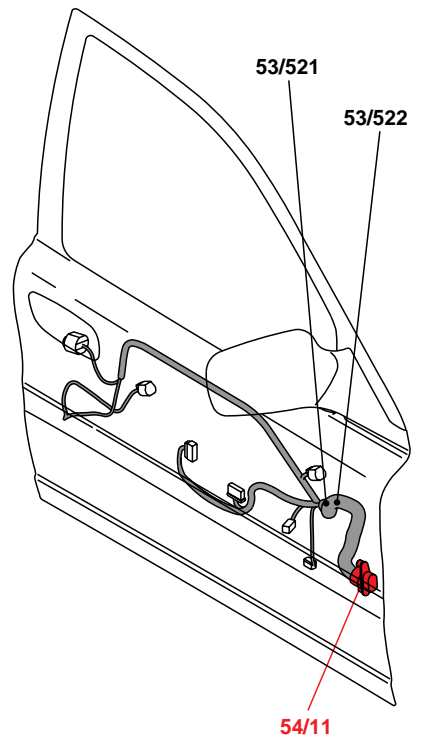
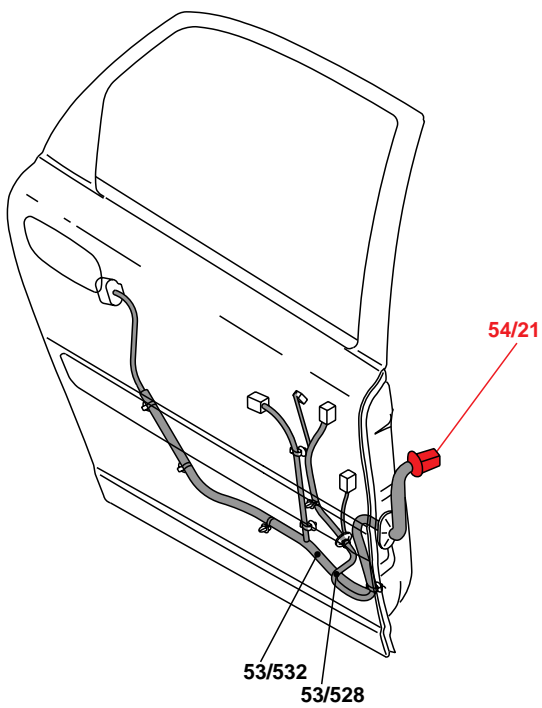
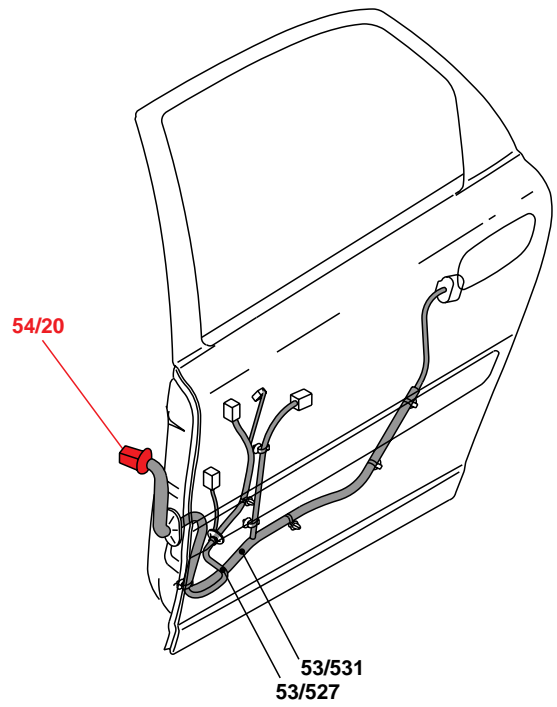
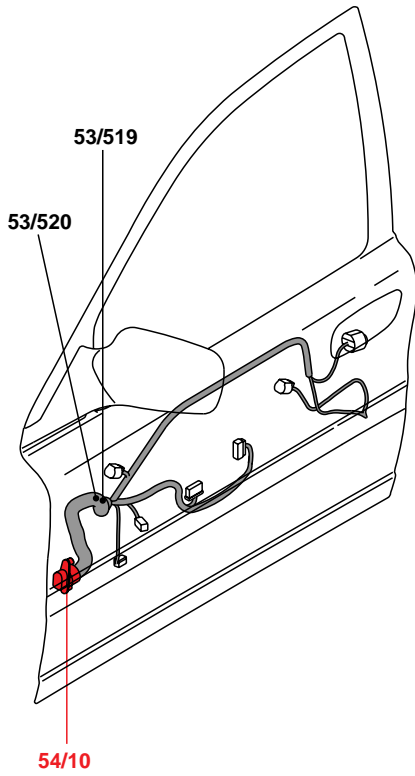

Pictures of components

1/1 - 2/52

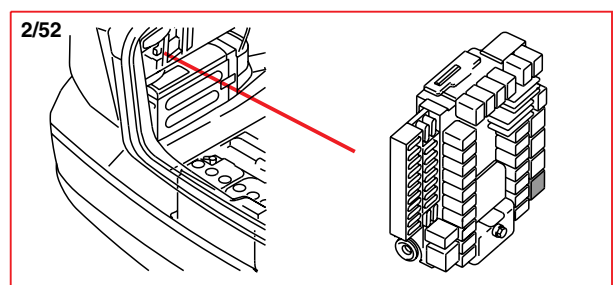
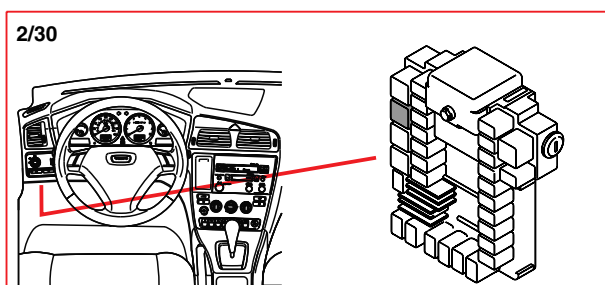
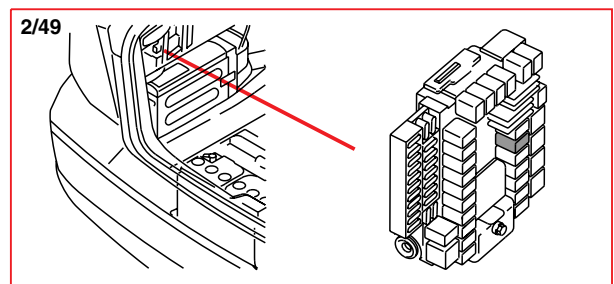
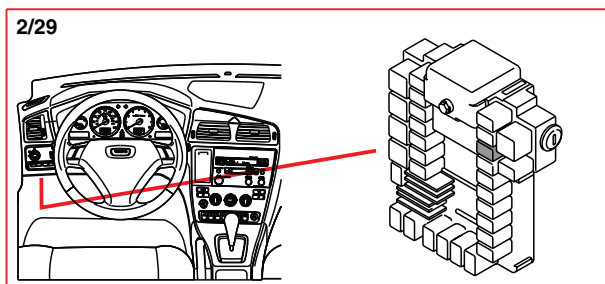
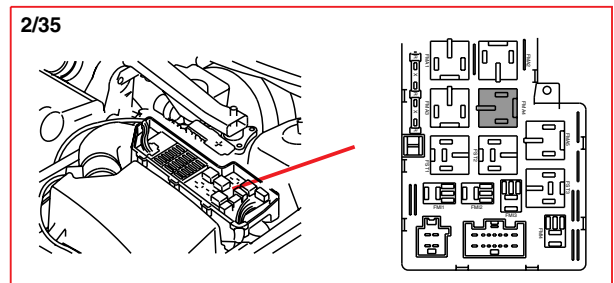
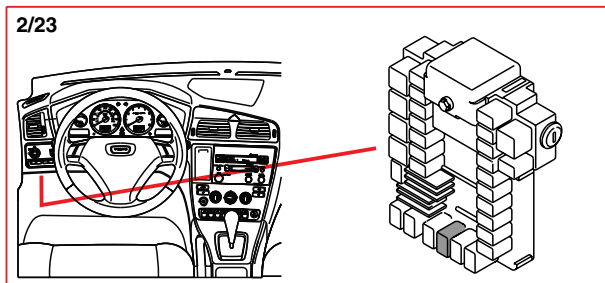
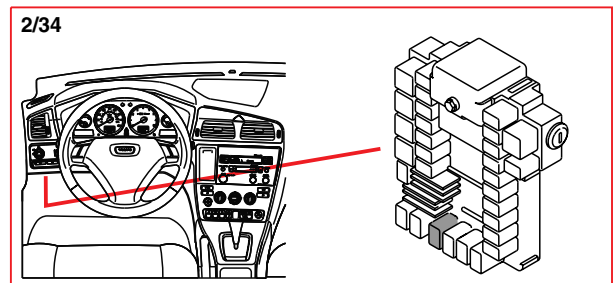
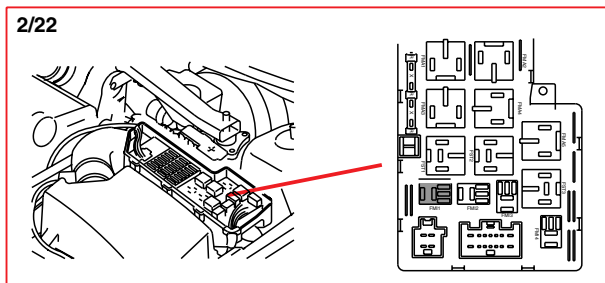
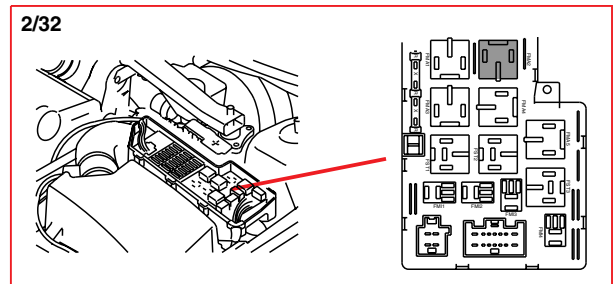
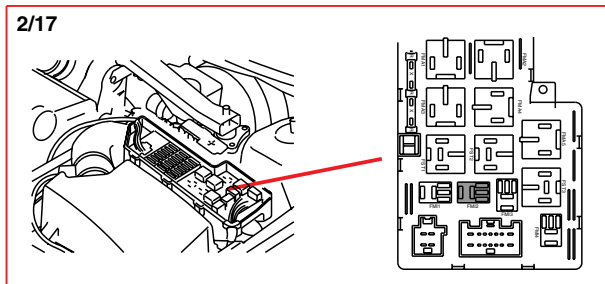
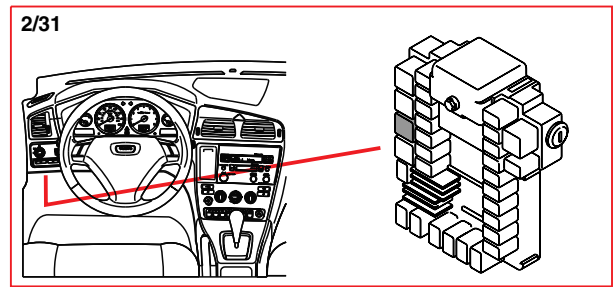
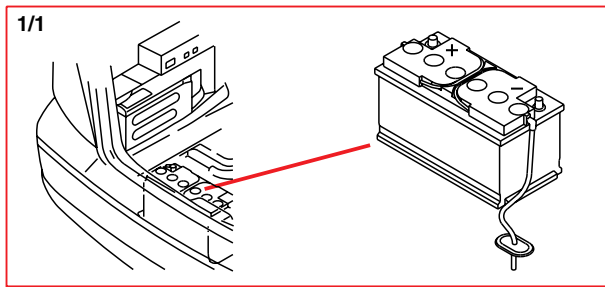

Pictures of components
2/58 - 2/90

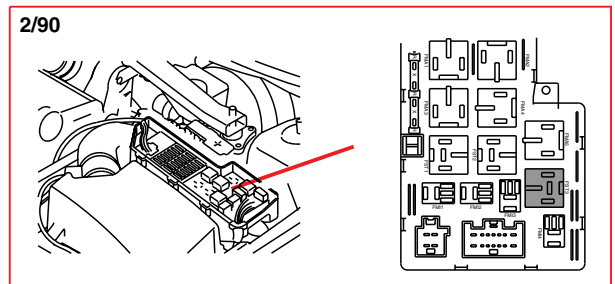
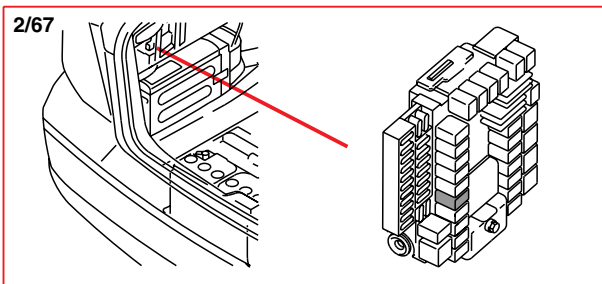
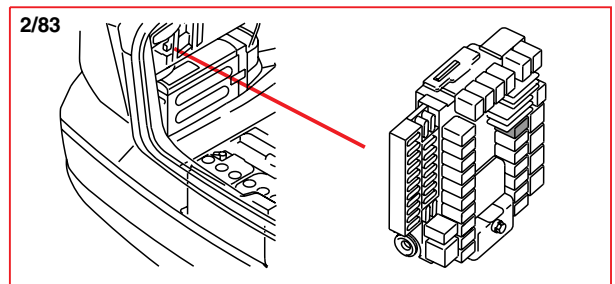
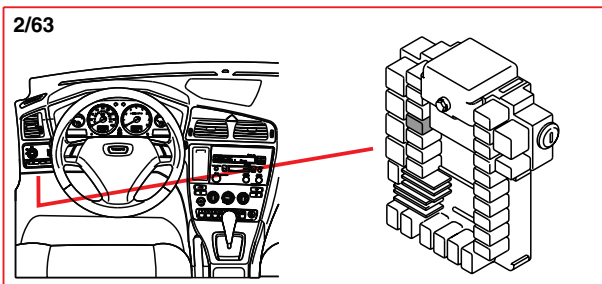
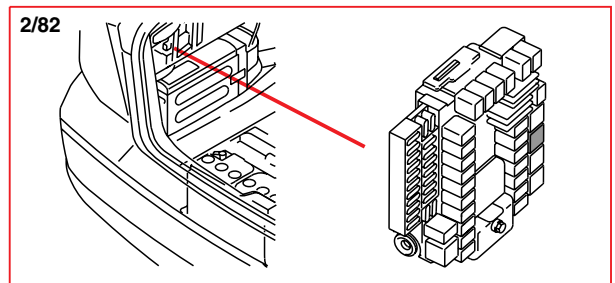
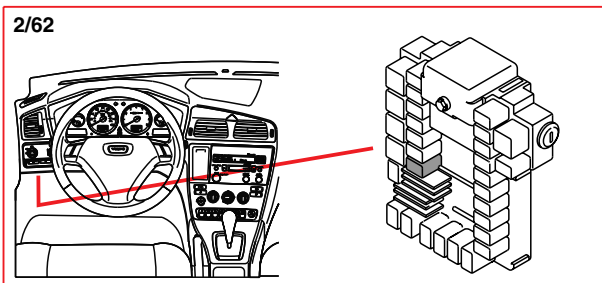
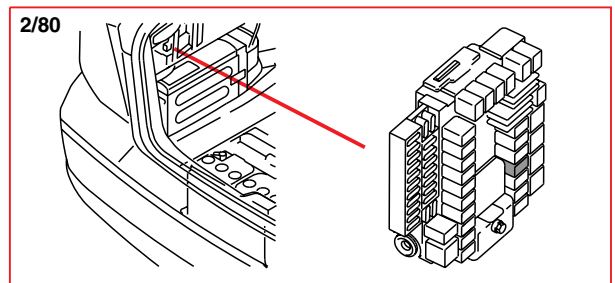
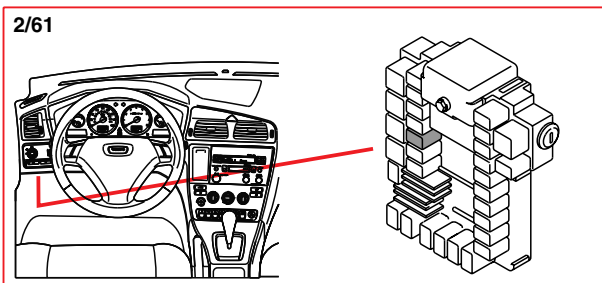
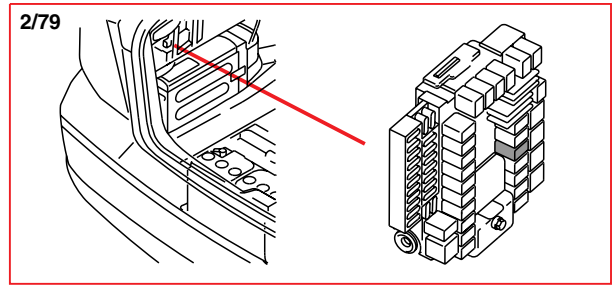
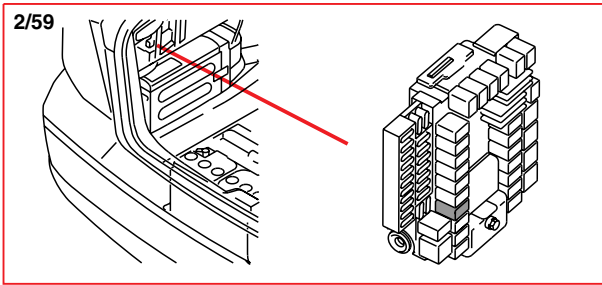
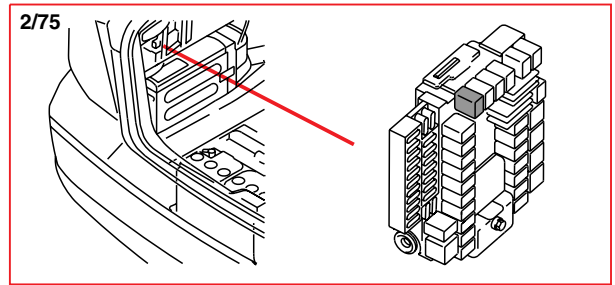
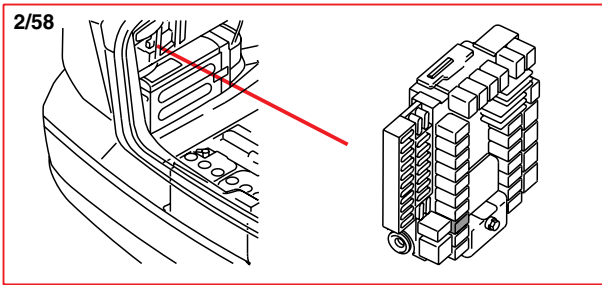

Pictures of components

2/91 - 2/119

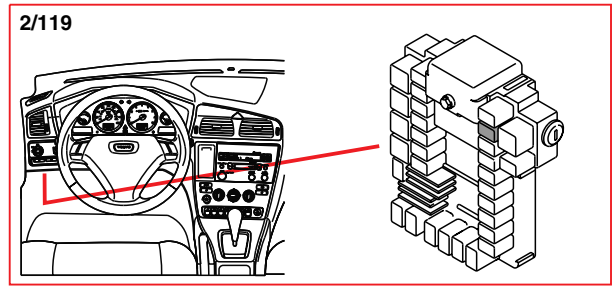
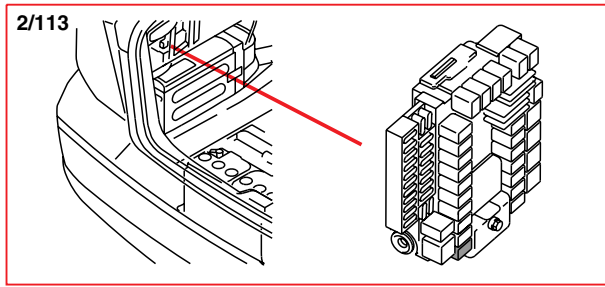
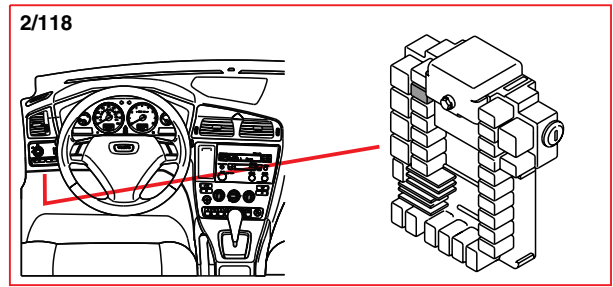
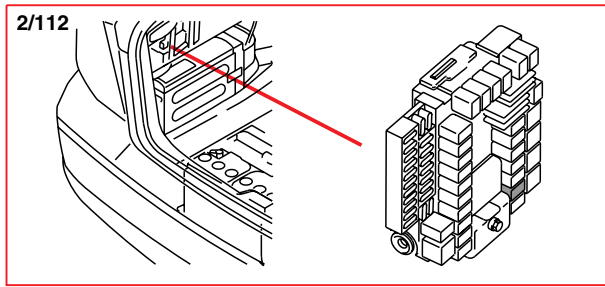
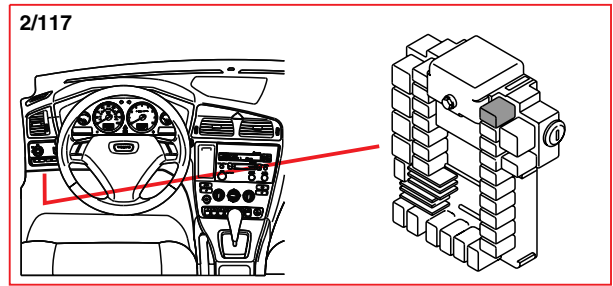
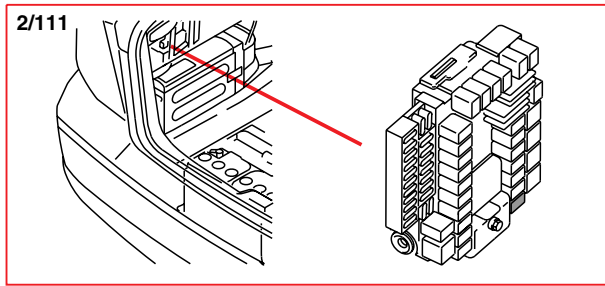
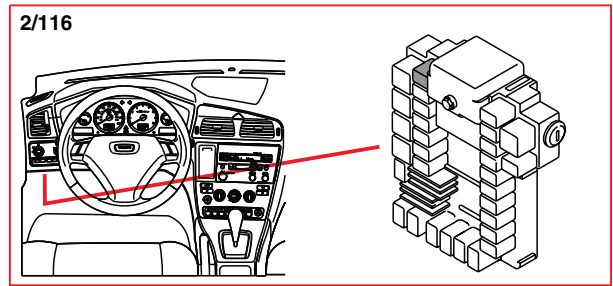
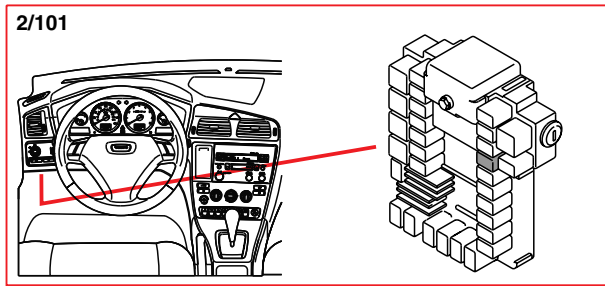
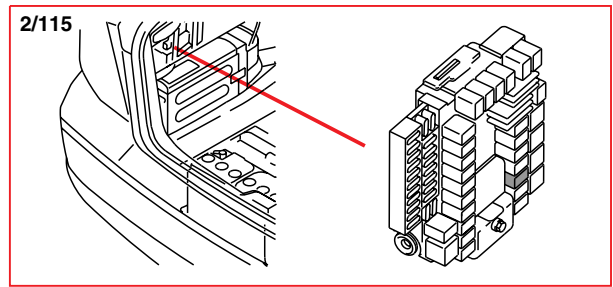
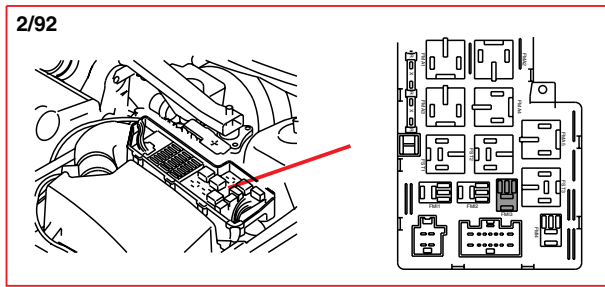
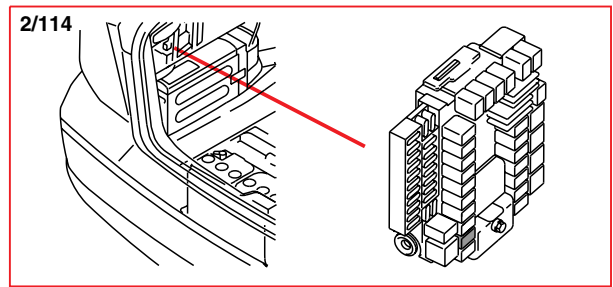
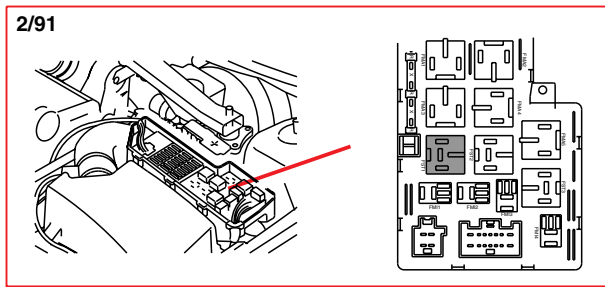

Pictures of components
2/120 - 3/25

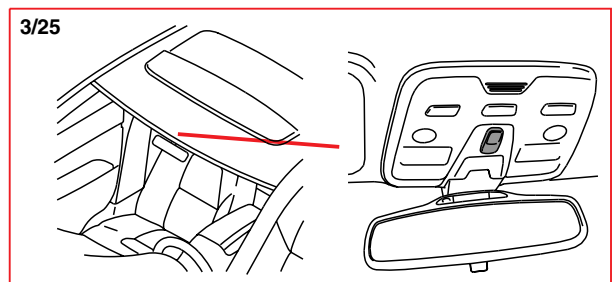
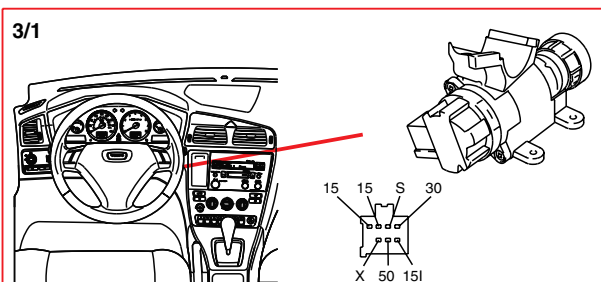
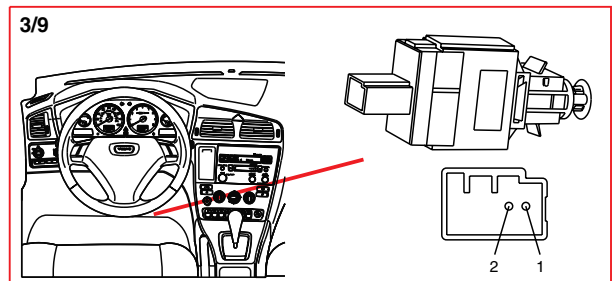
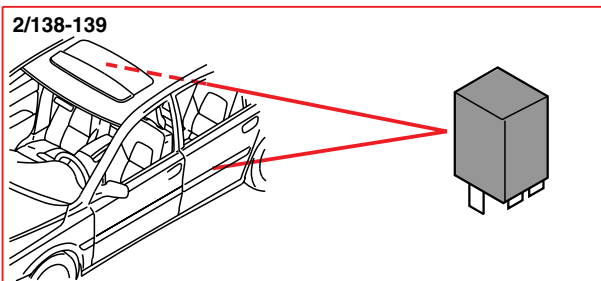
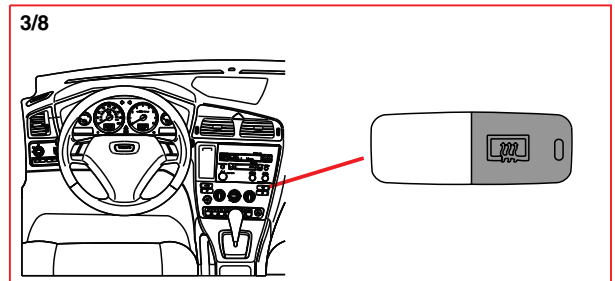
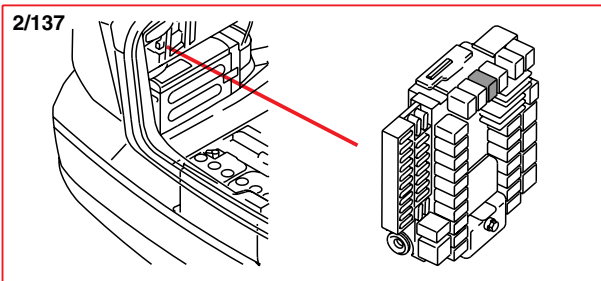
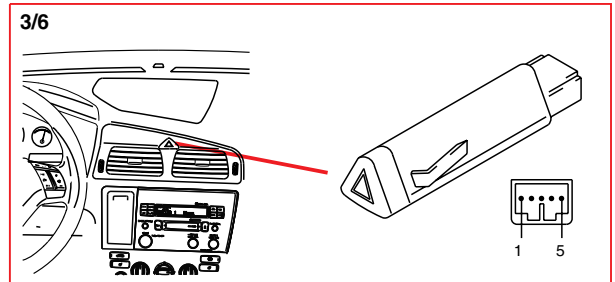
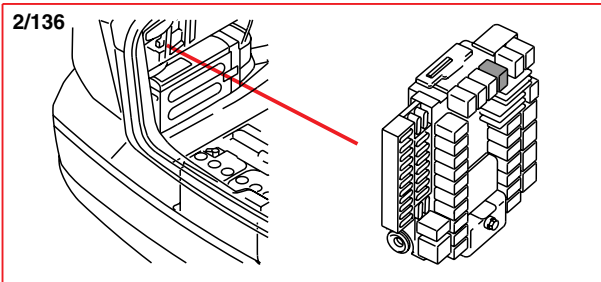
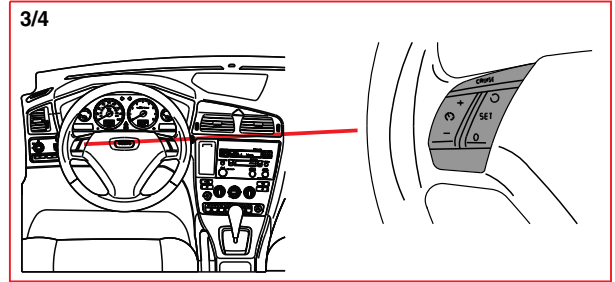
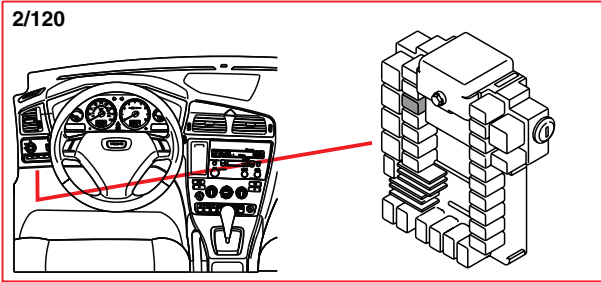

Pictures of components

3/26 - 3/78

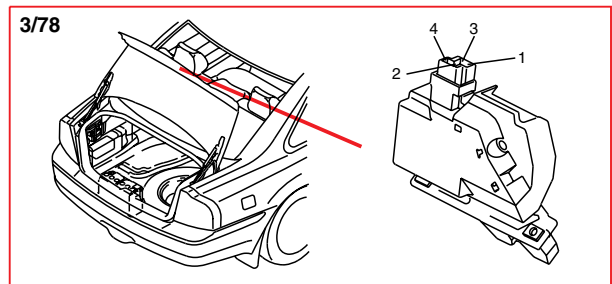
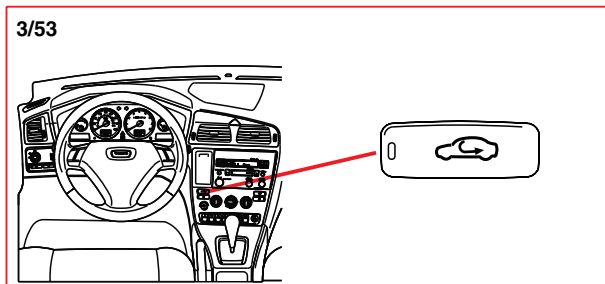
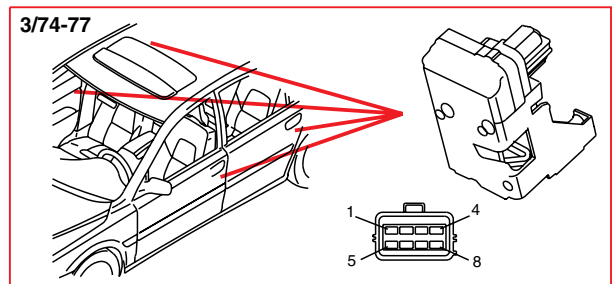
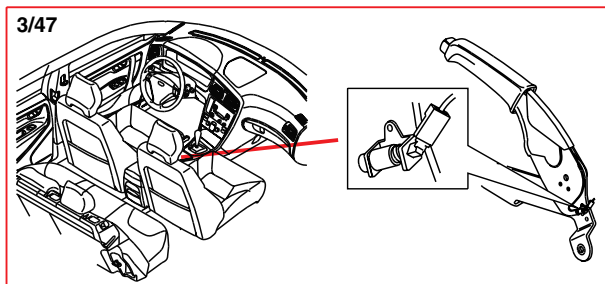
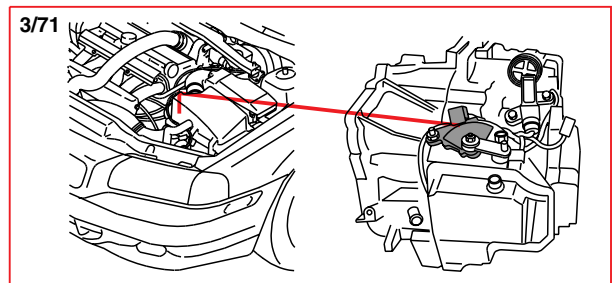
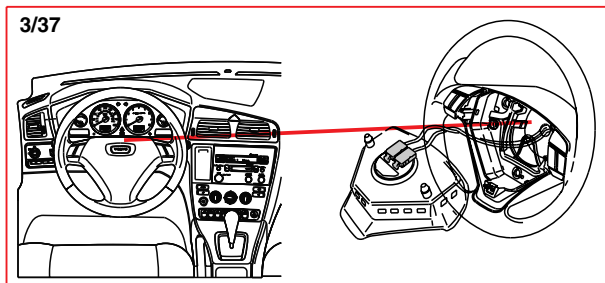
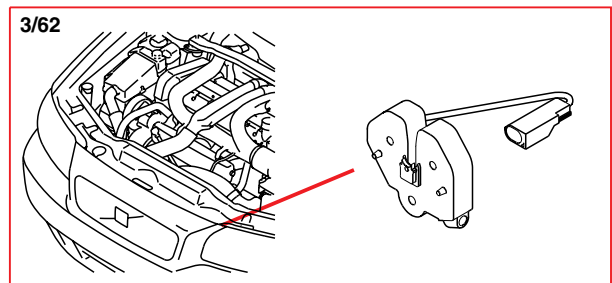
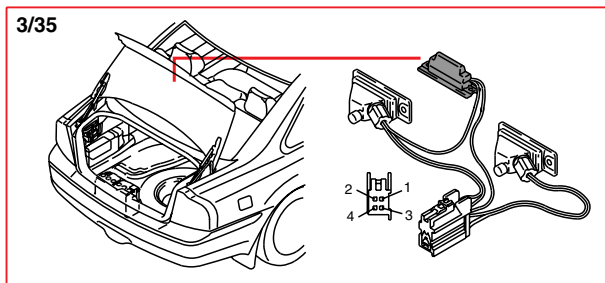
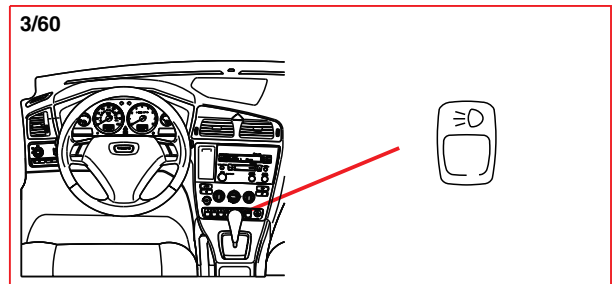
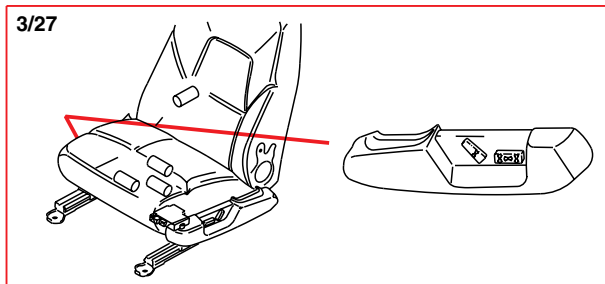
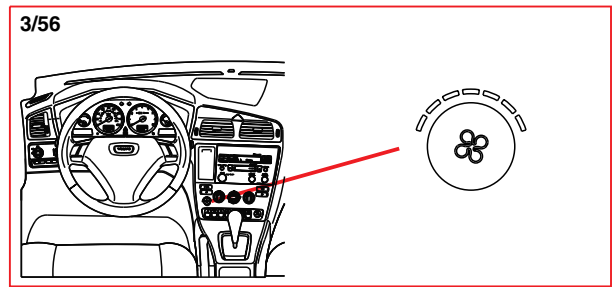
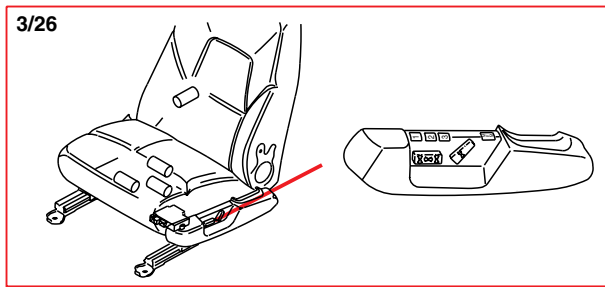

Pictures of components
3/80 - 3/127

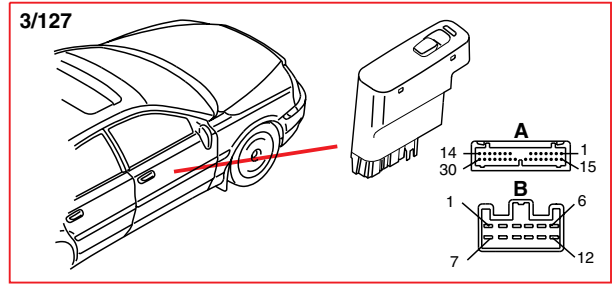
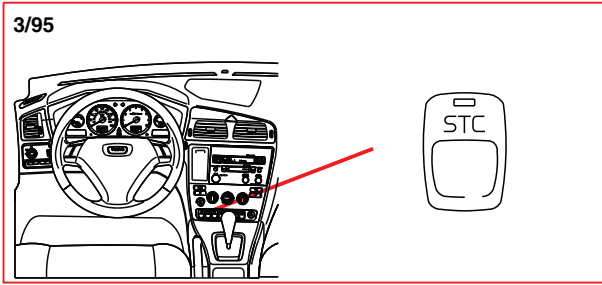
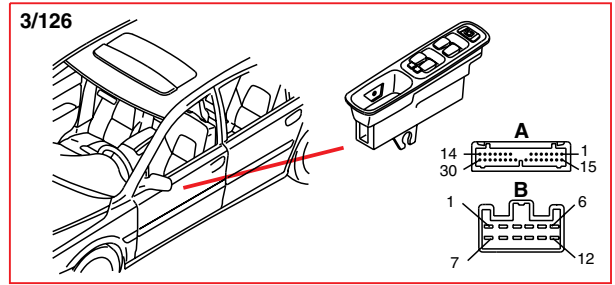
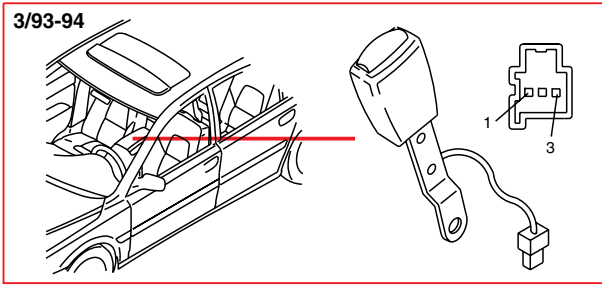
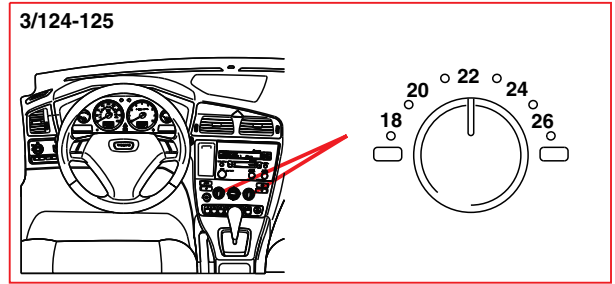
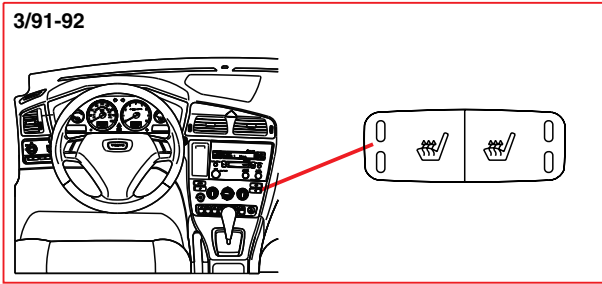
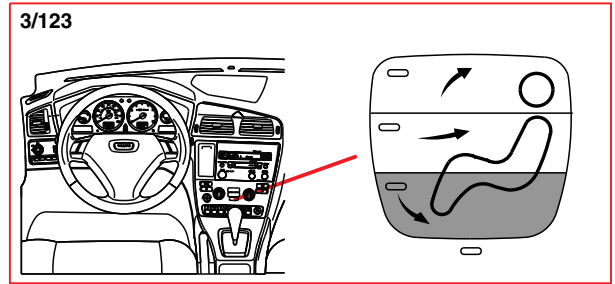
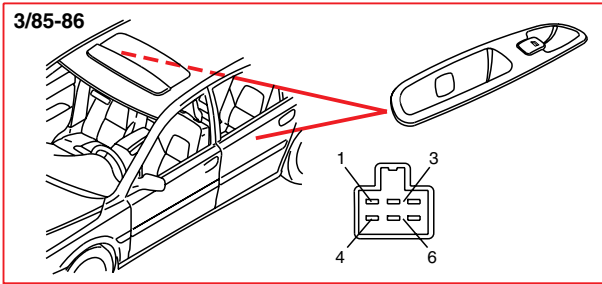
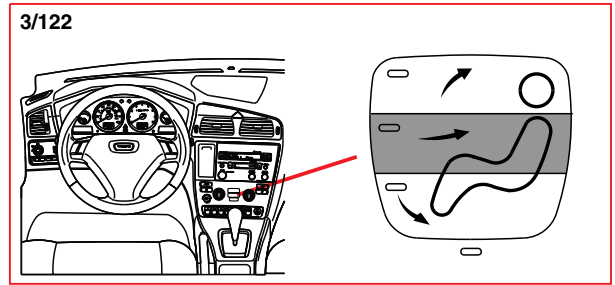
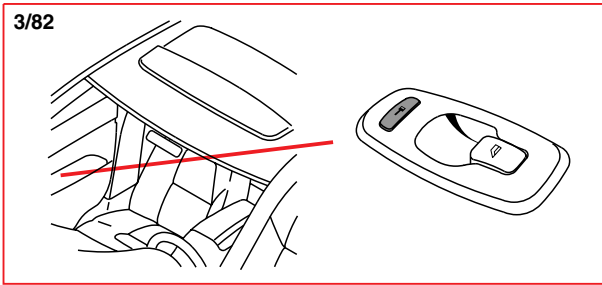
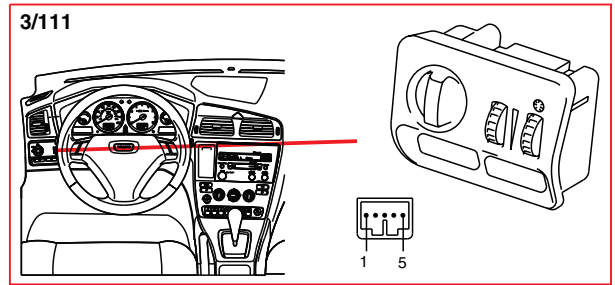
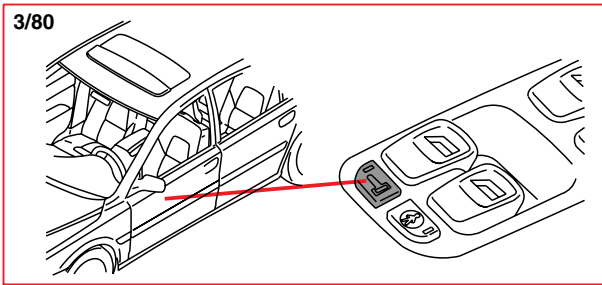

Pictures of components

3/130 - 4/7

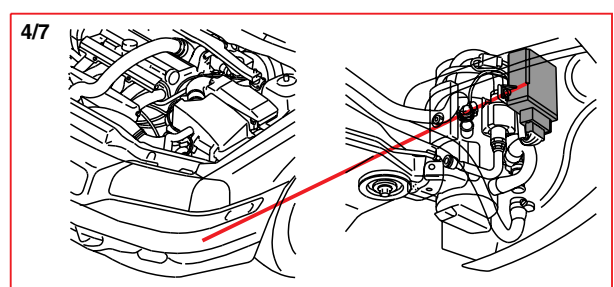
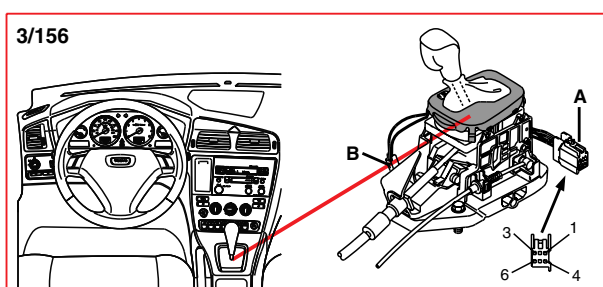
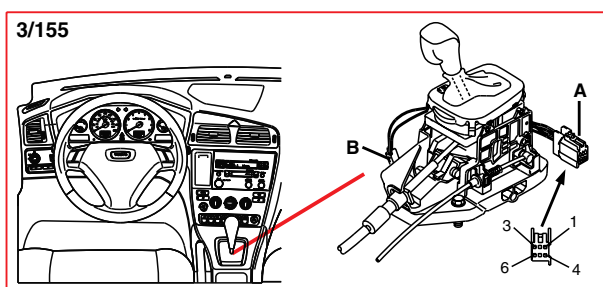
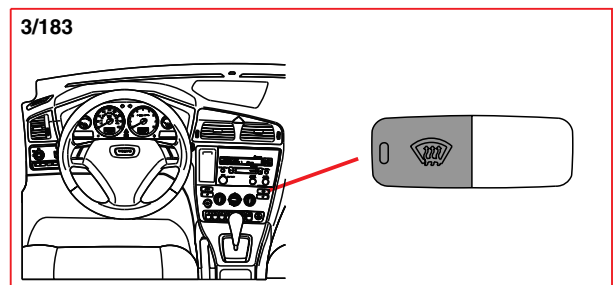
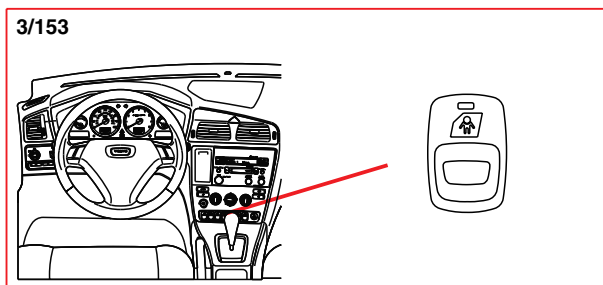
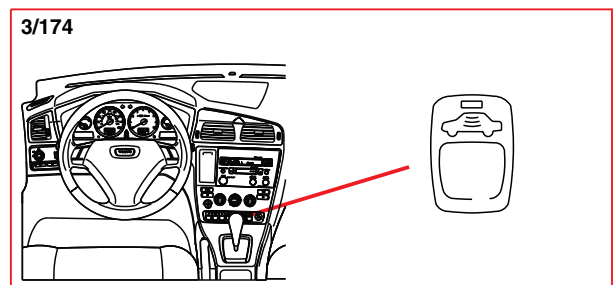
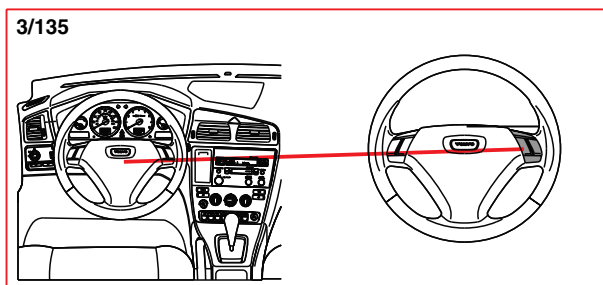
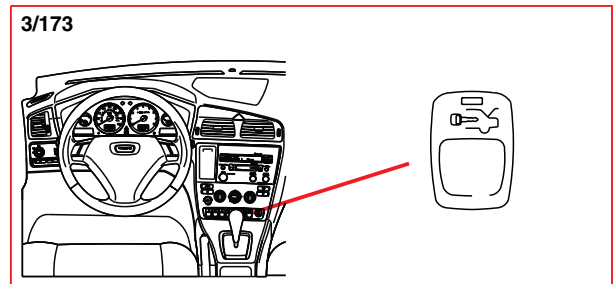
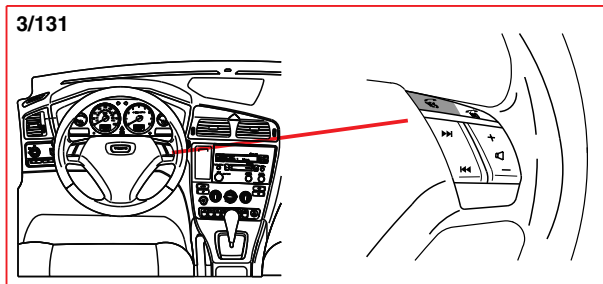
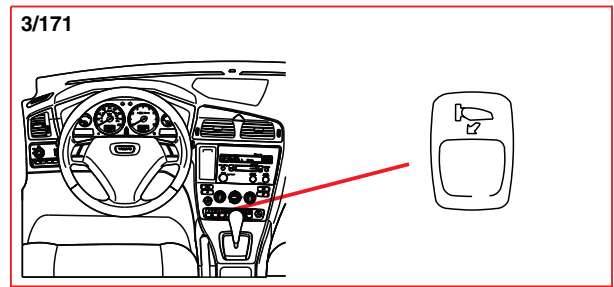
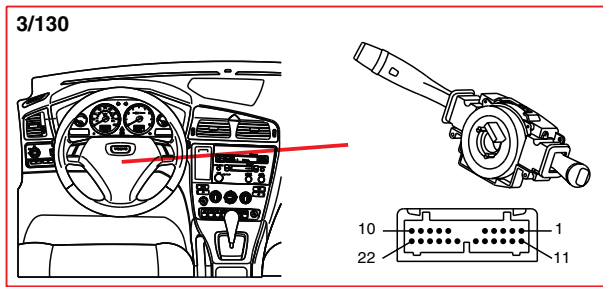

Pictures of components

4/9 - 4/70

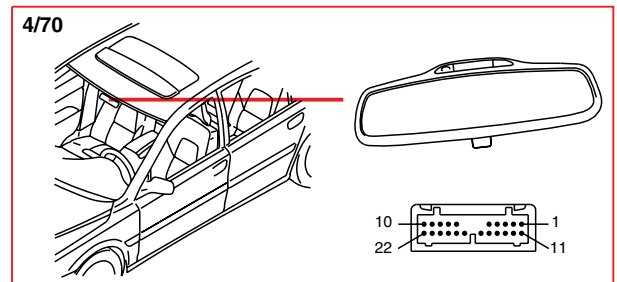
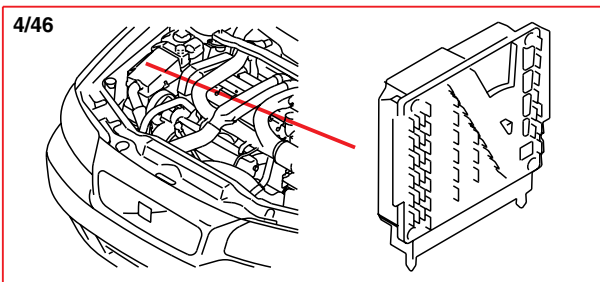
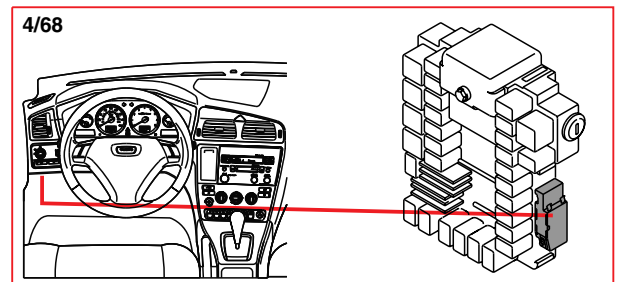
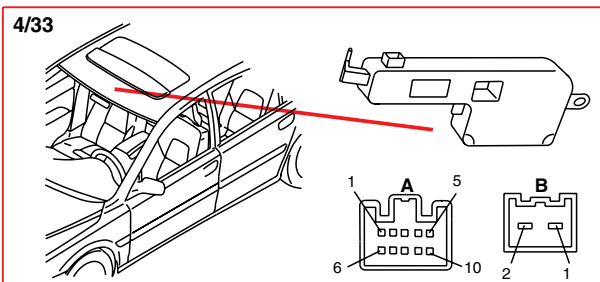
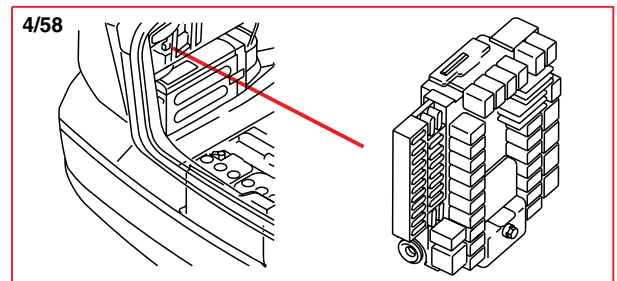
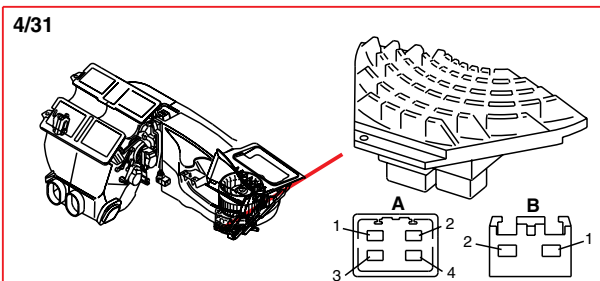
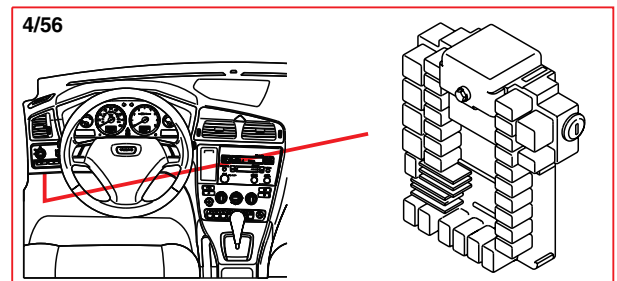
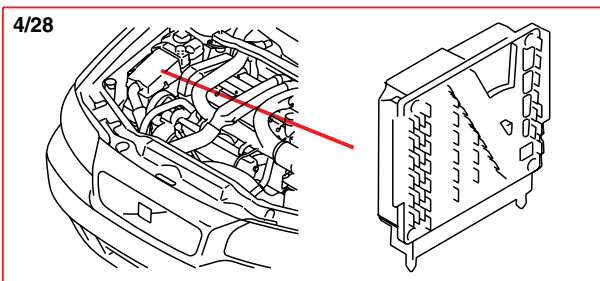
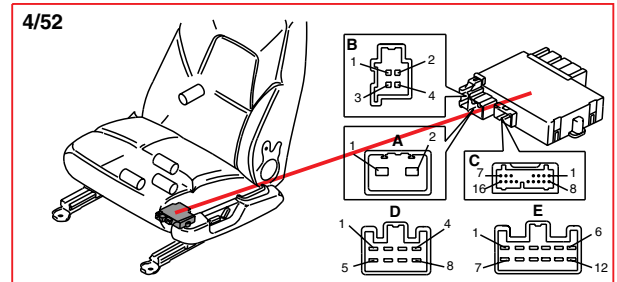
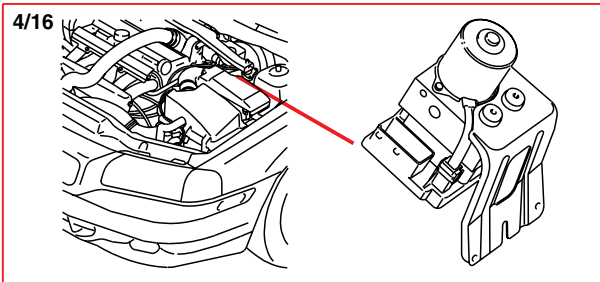
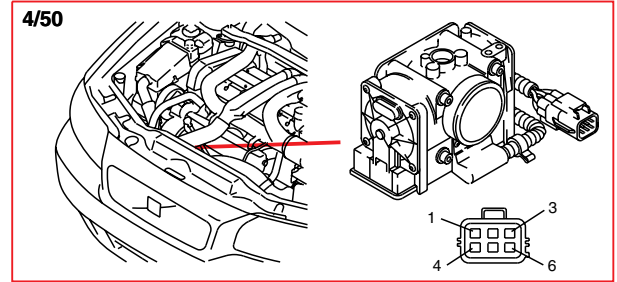
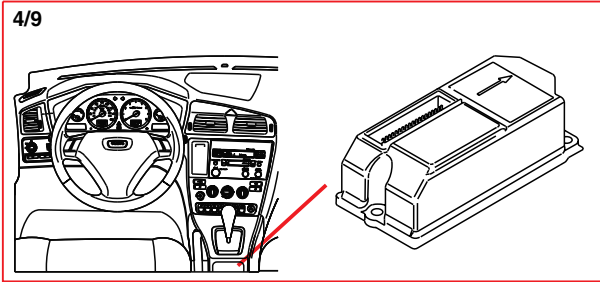

Pictures of components

4/71 - 6/15

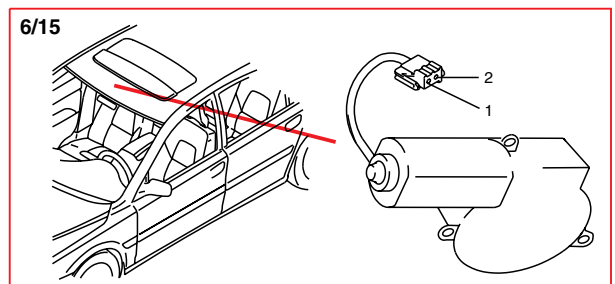
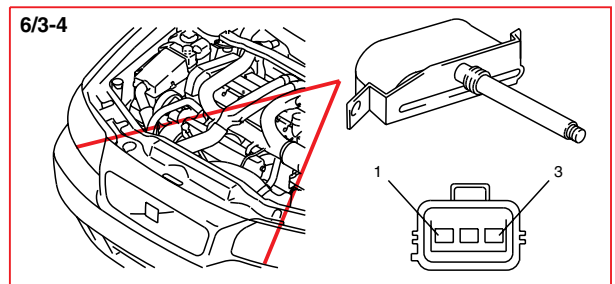
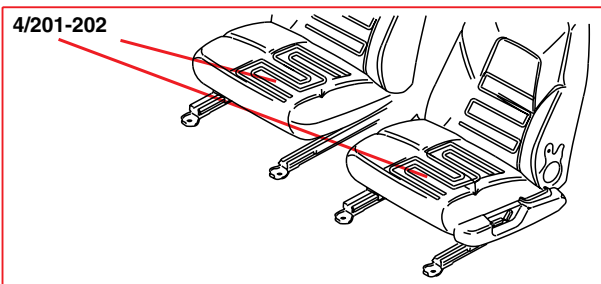
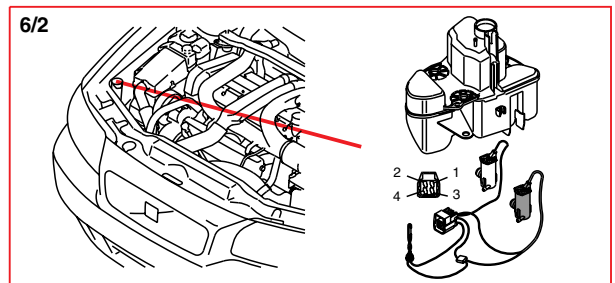
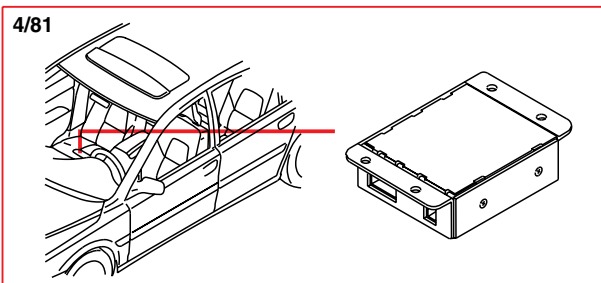
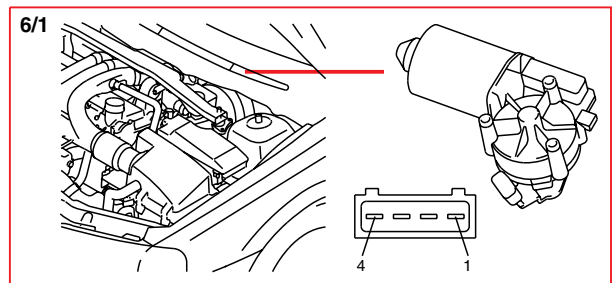
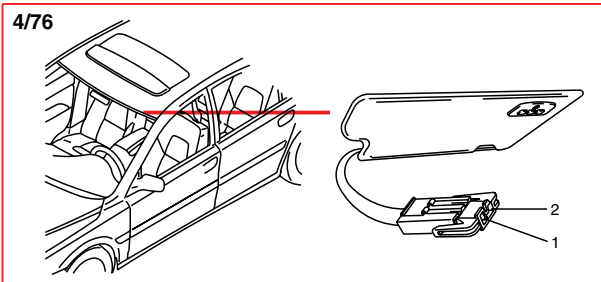
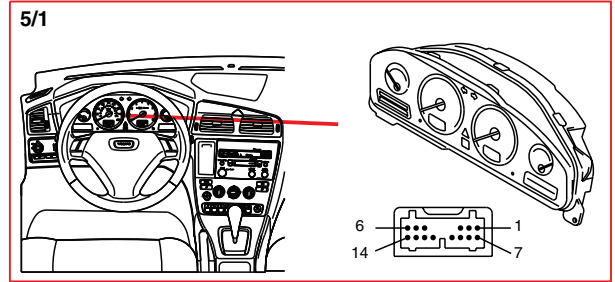
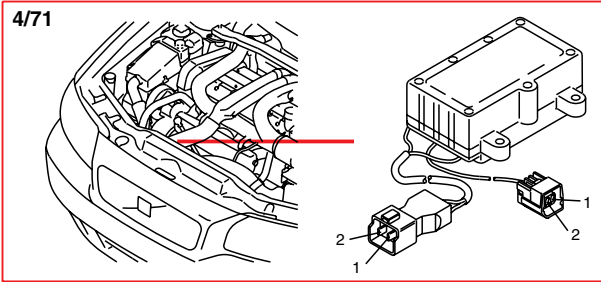

Pictures of components
6/16 - 6/37

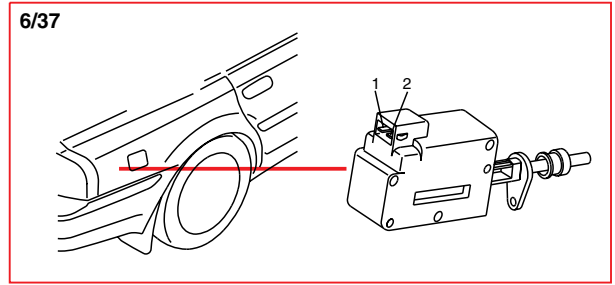
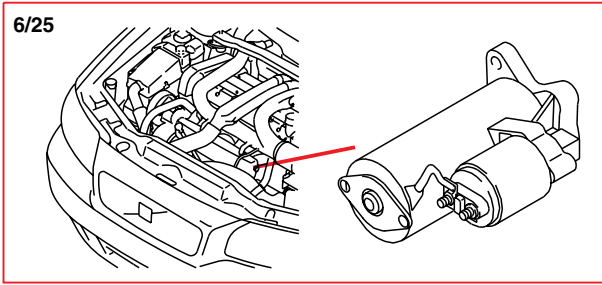
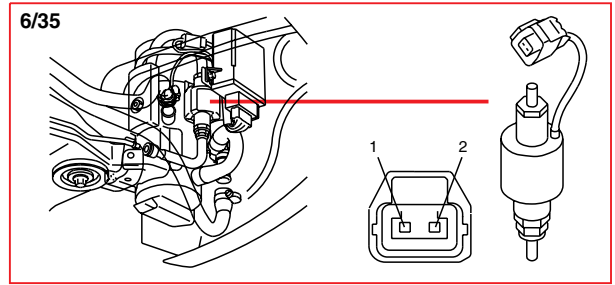
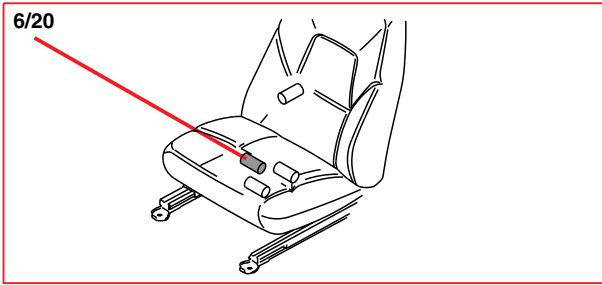
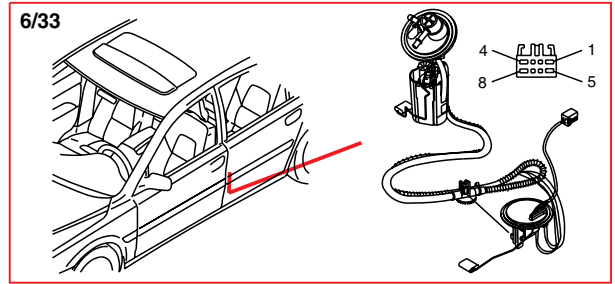
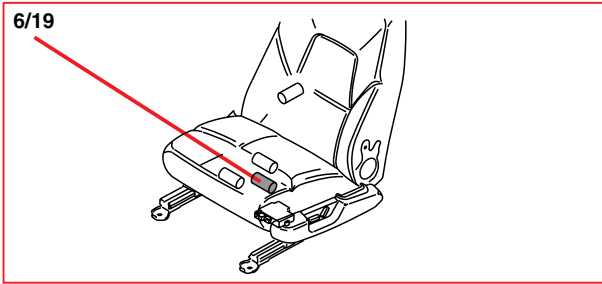
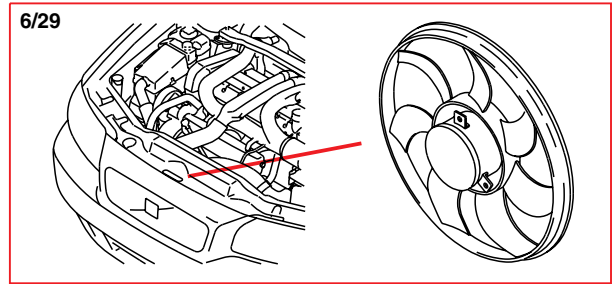
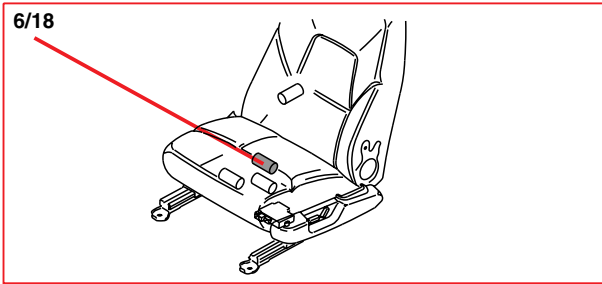
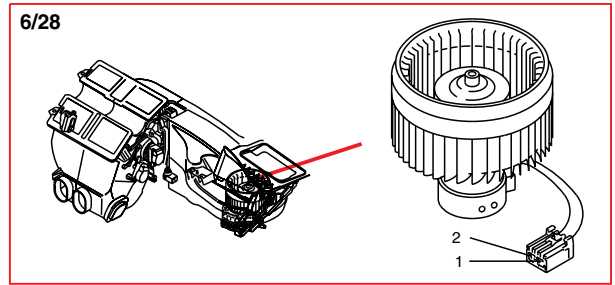
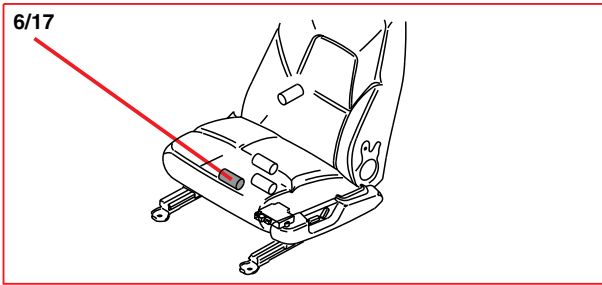
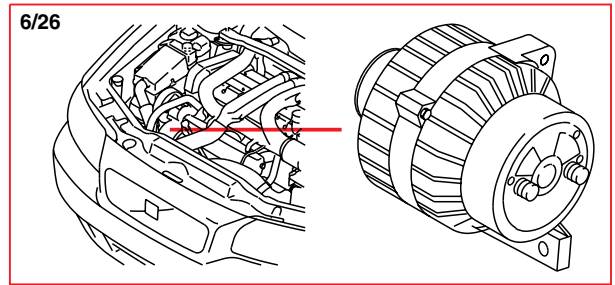
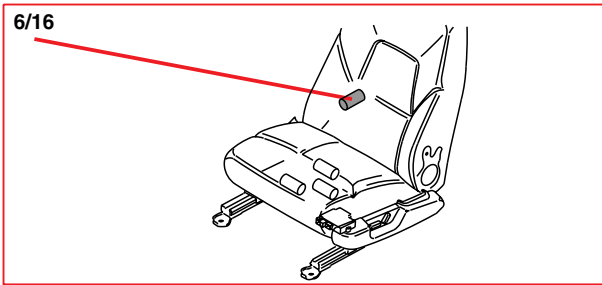

Pictures of components

6/38 - 6/95

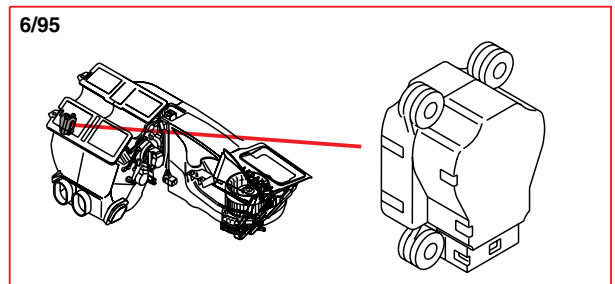
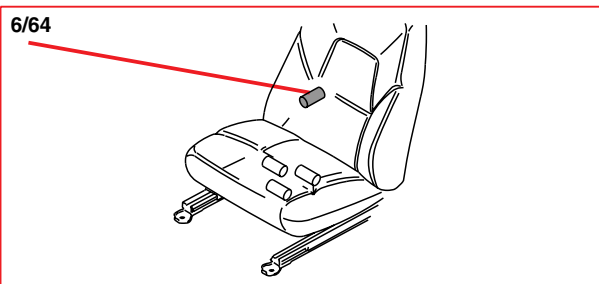
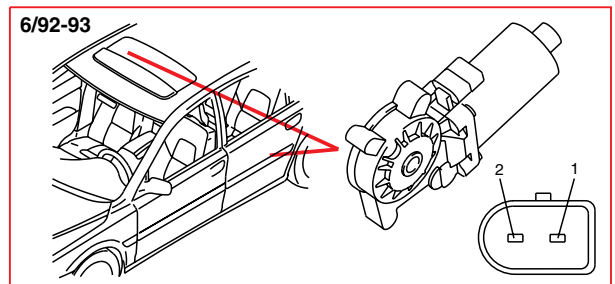
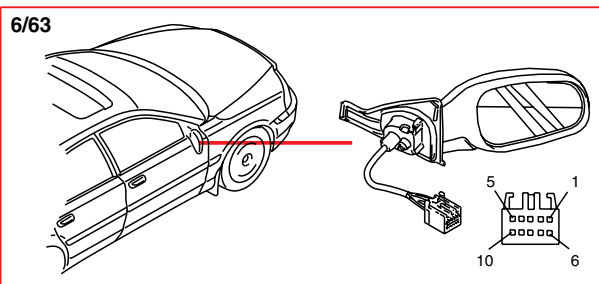
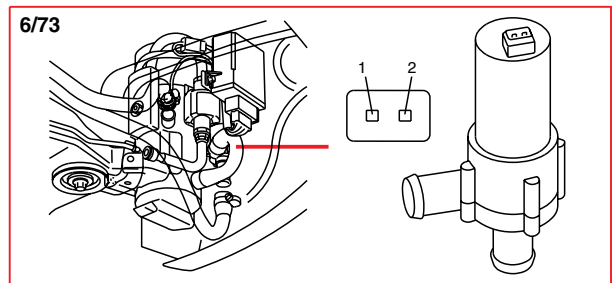
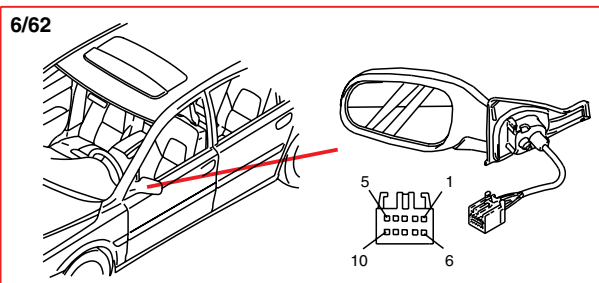
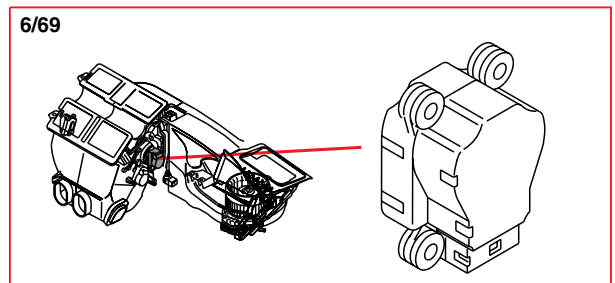
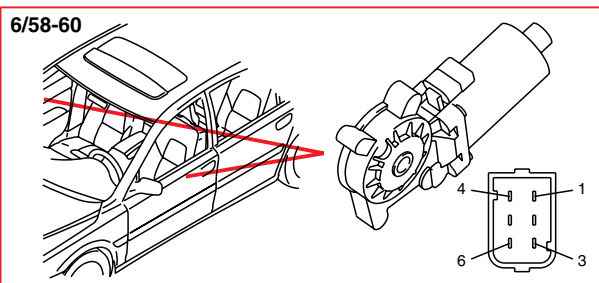
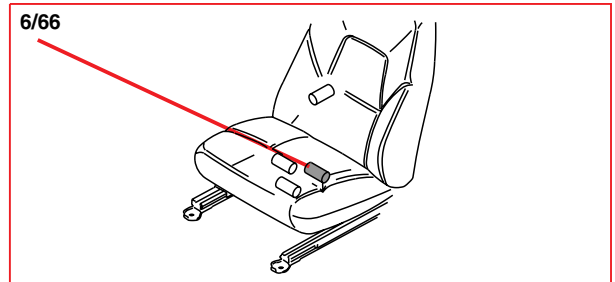
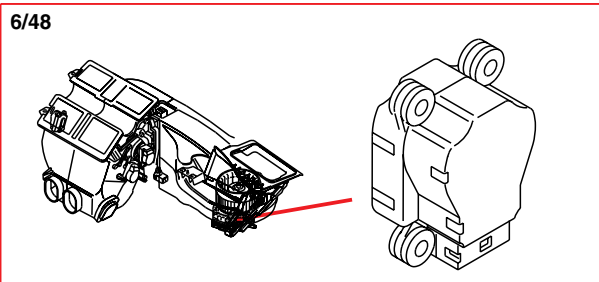
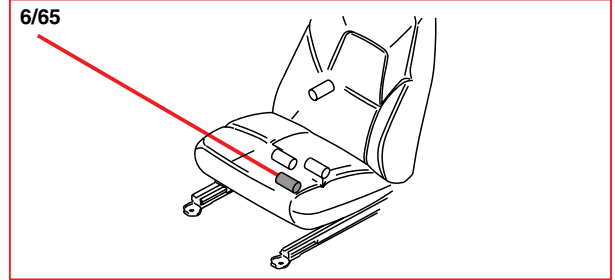
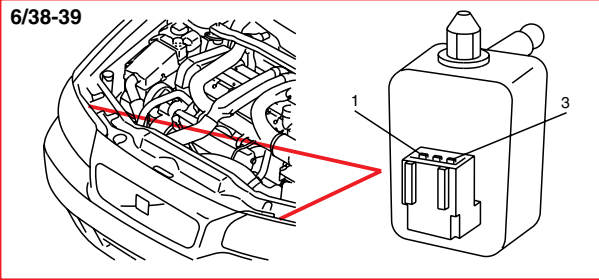

Pictures of components 6/96 - 7/15

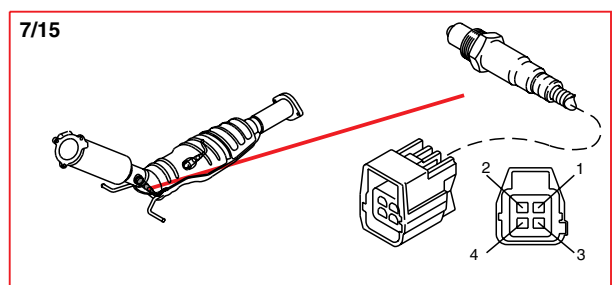
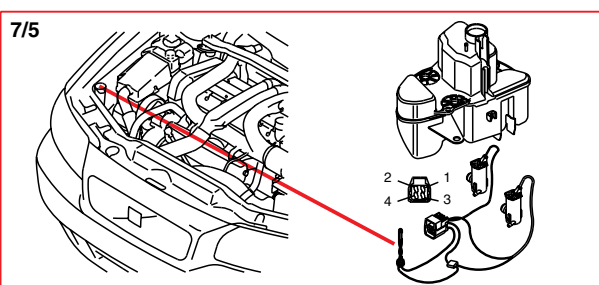
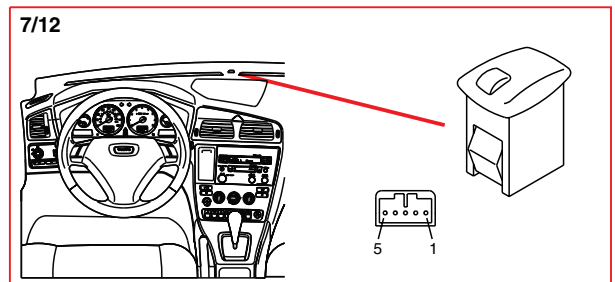
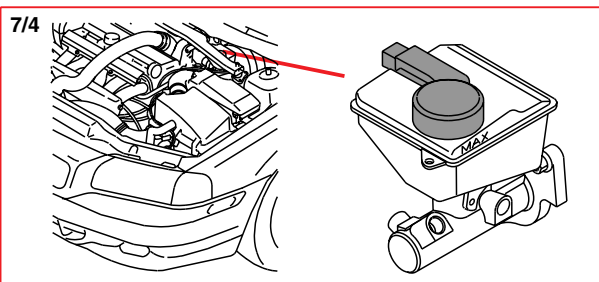
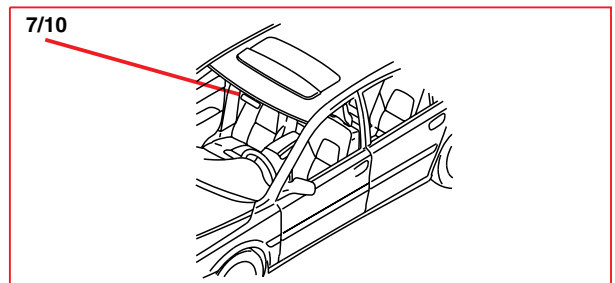
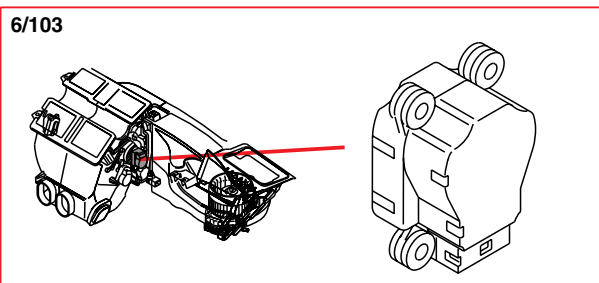
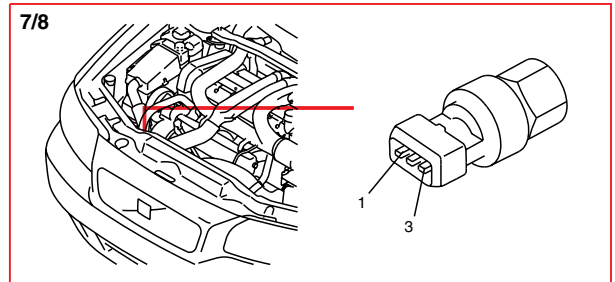
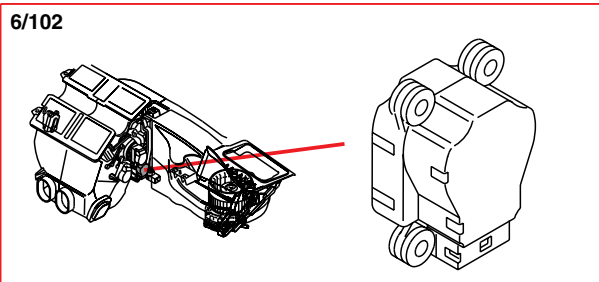
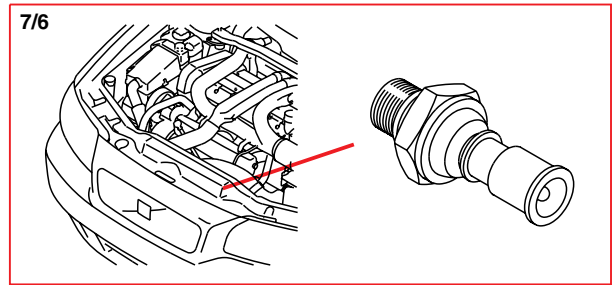
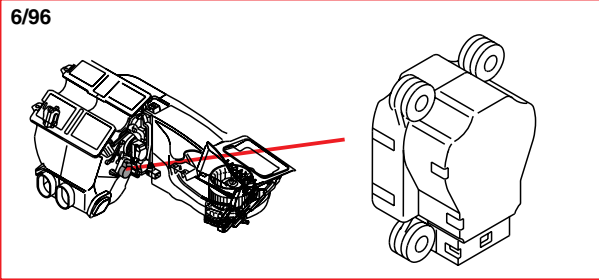

Pictures of components

7/16 - 7/73

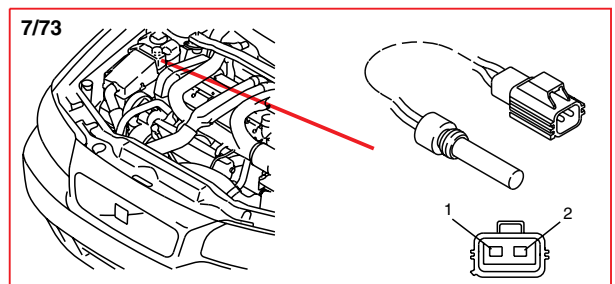
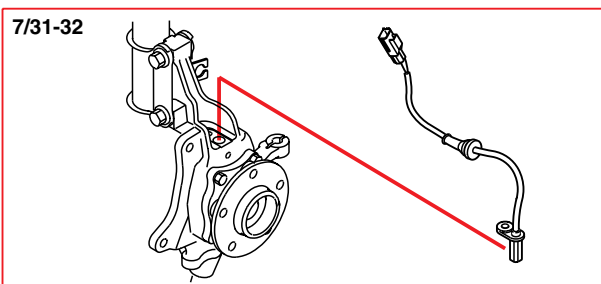
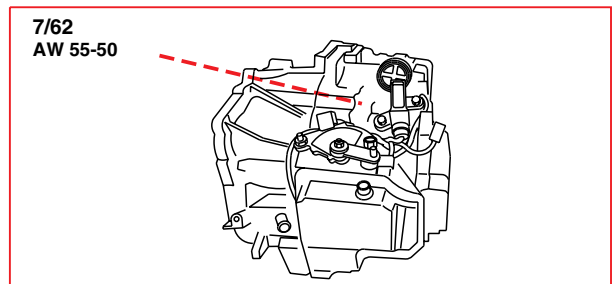
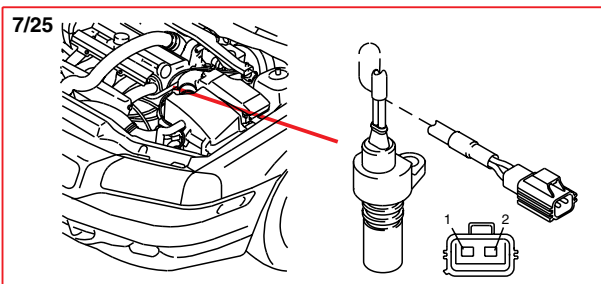
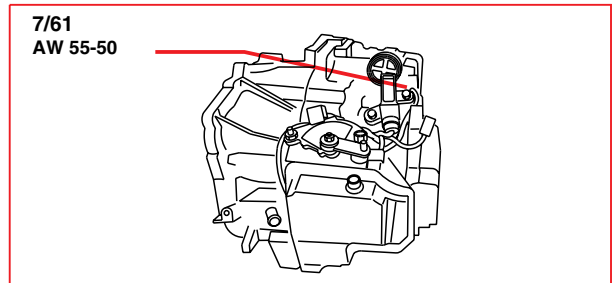
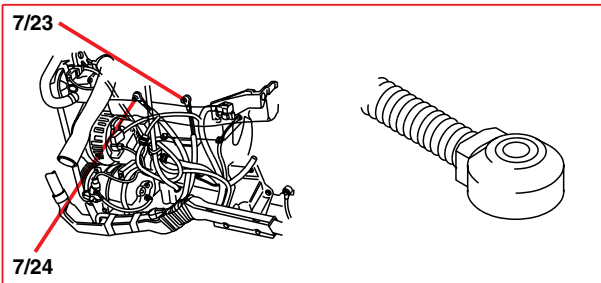
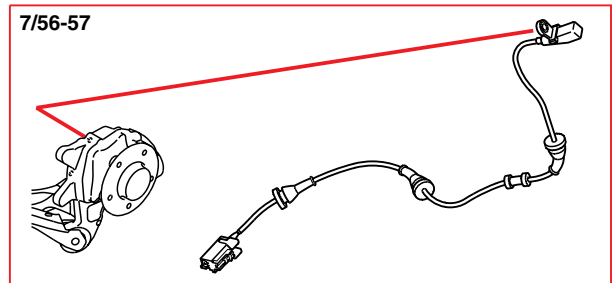
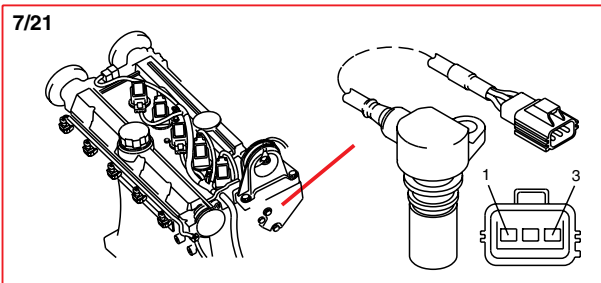
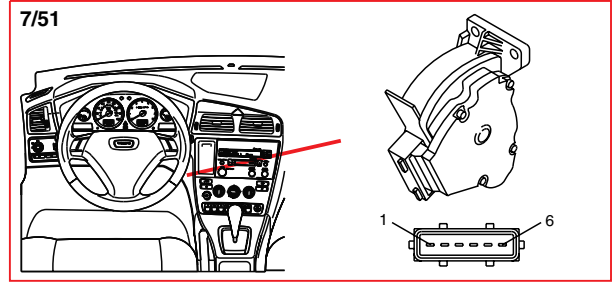
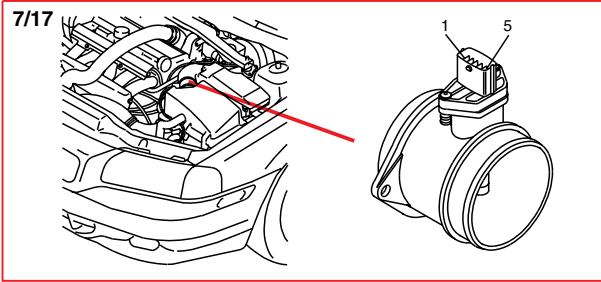
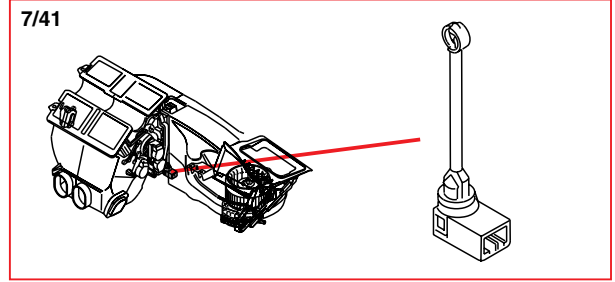
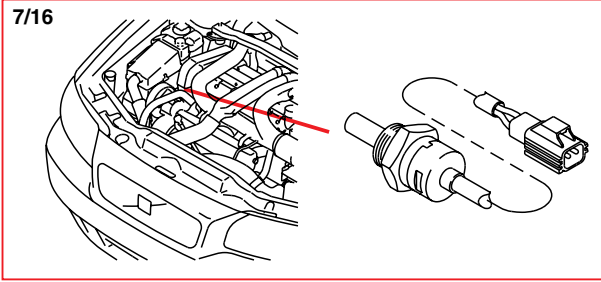

Pictures of components 7/74 - 7/122

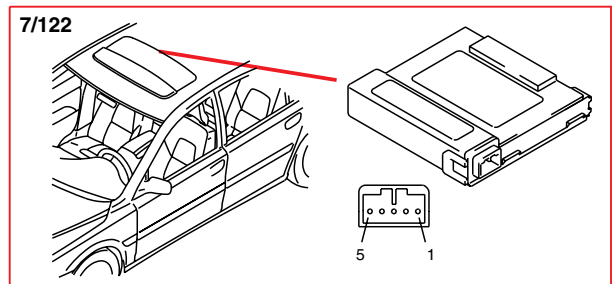
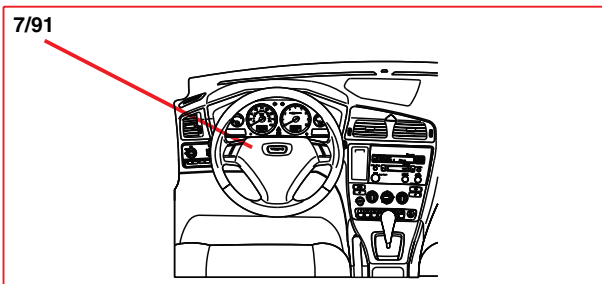
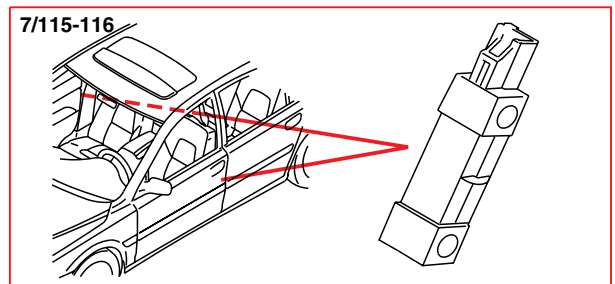
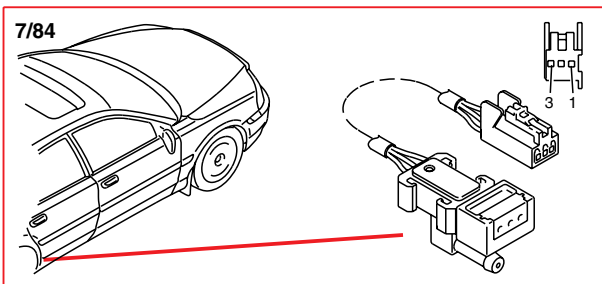
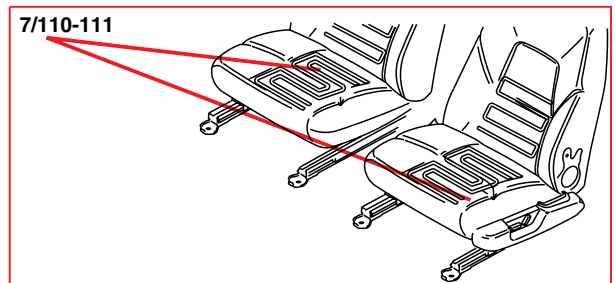
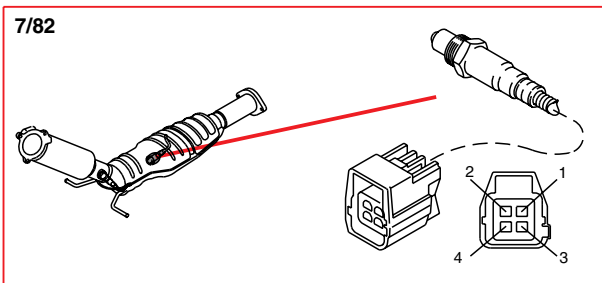
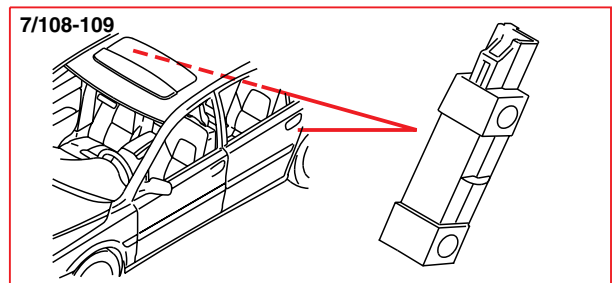
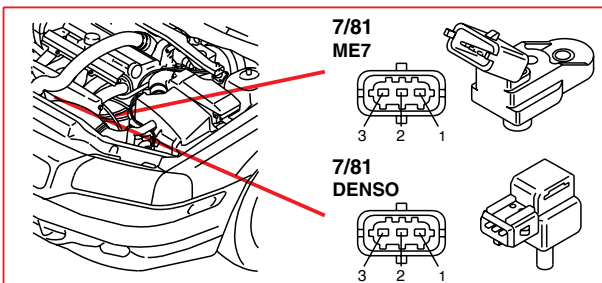
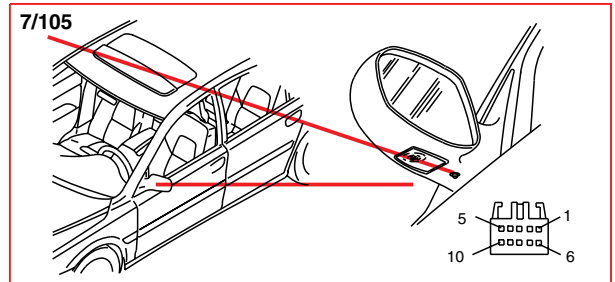
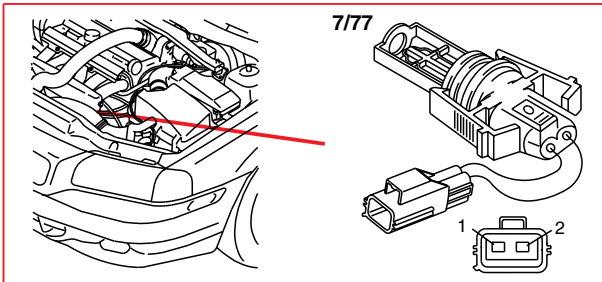
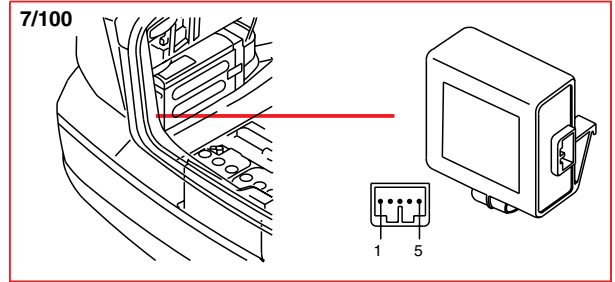
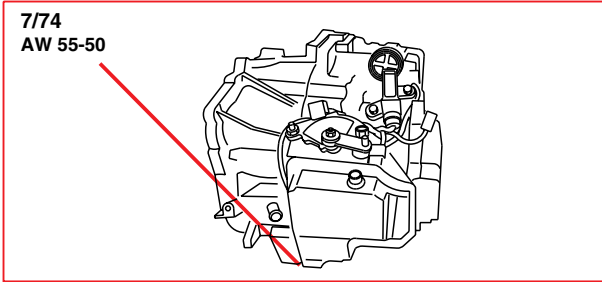

Pictures of components

7/123 - 7/159

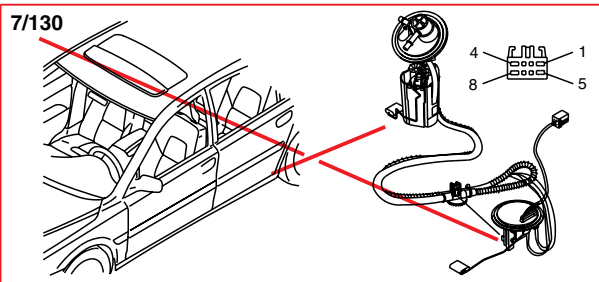
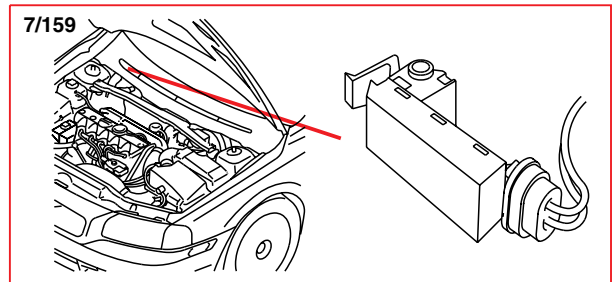
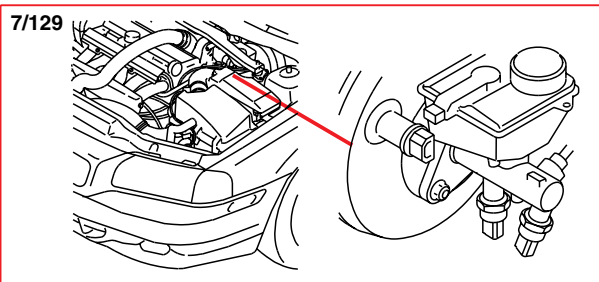
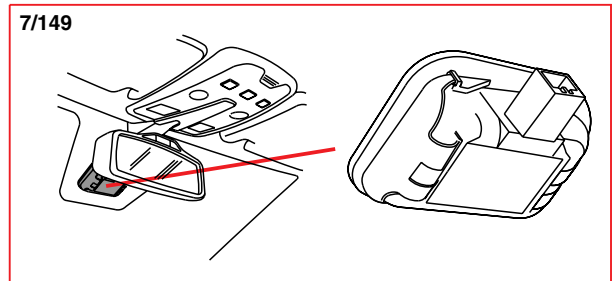
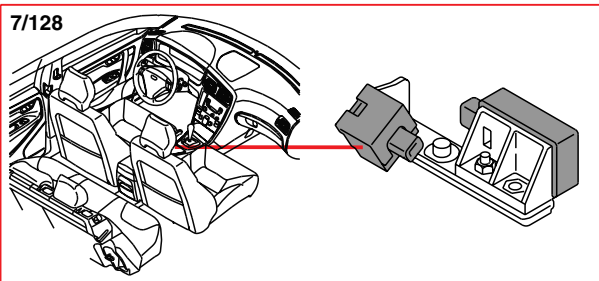
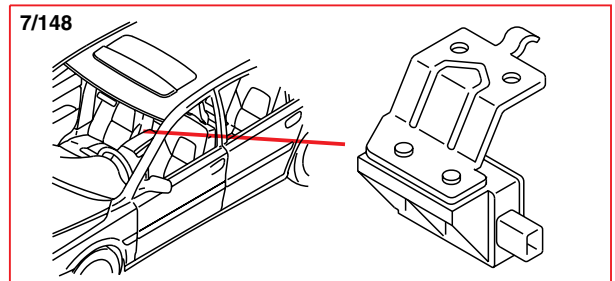
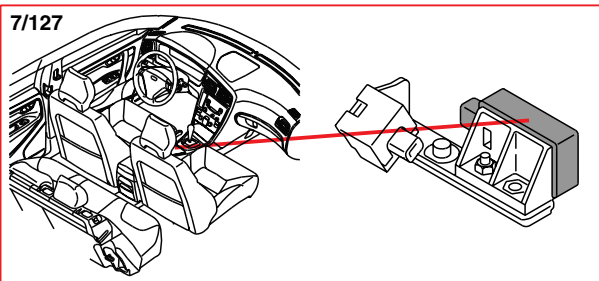
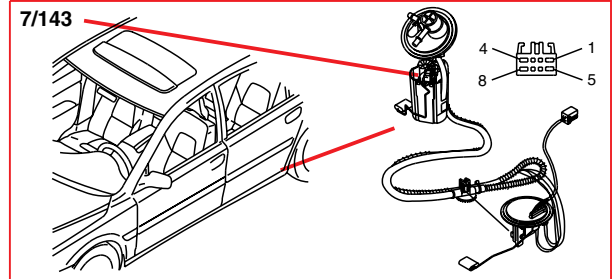
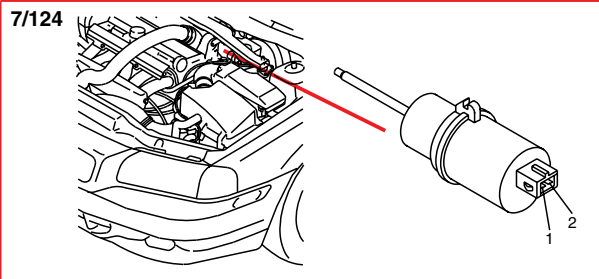
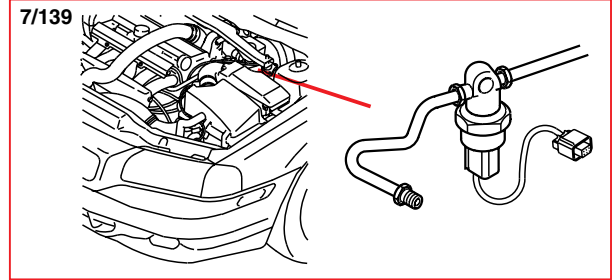
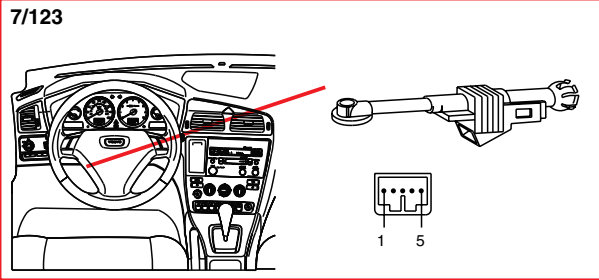

Pictures of components
8/3 - 8/41

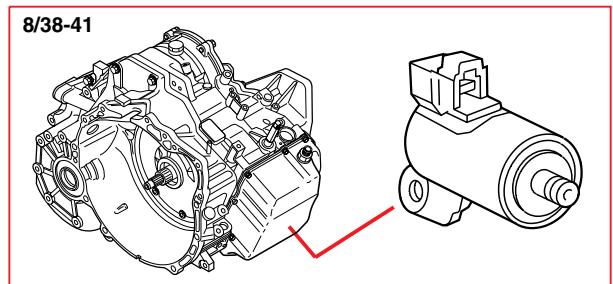
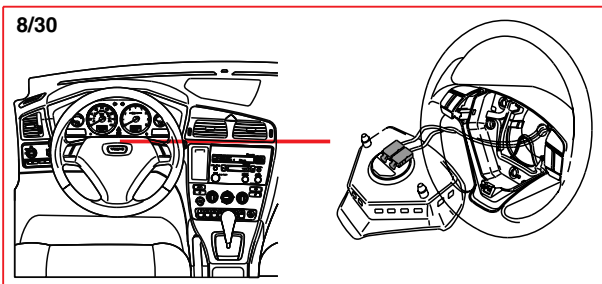
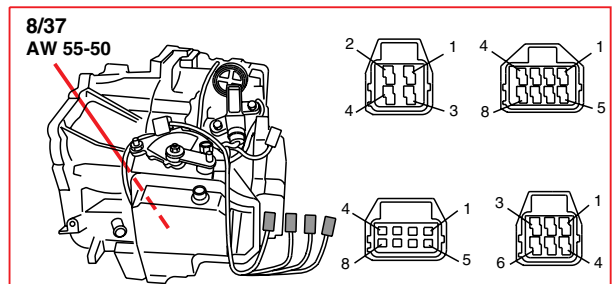
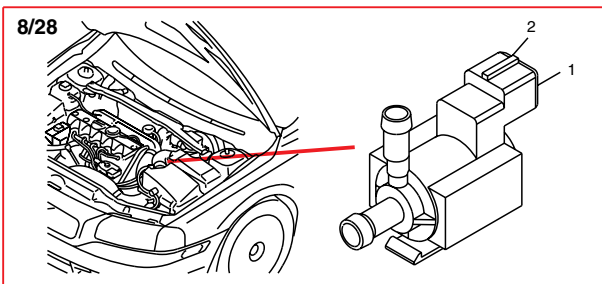
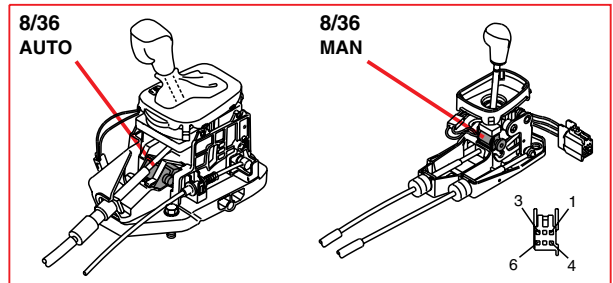
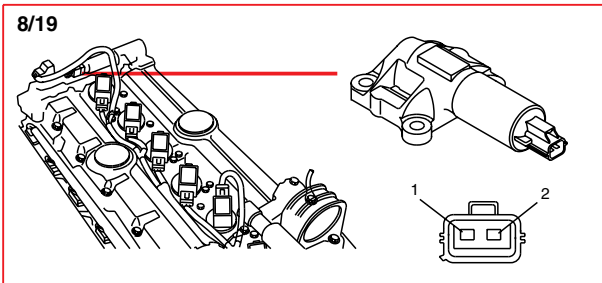
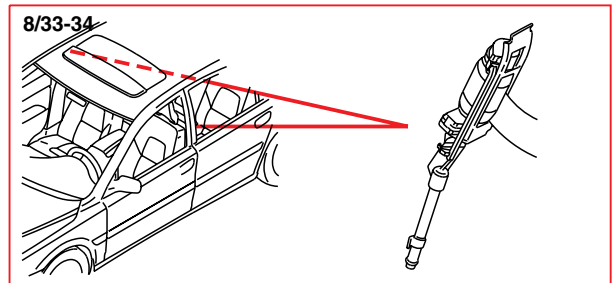
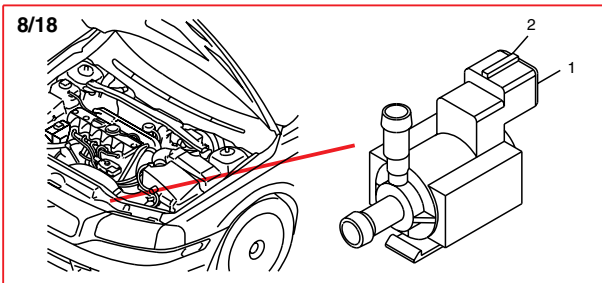
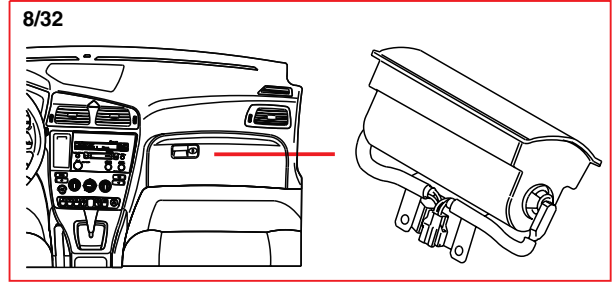
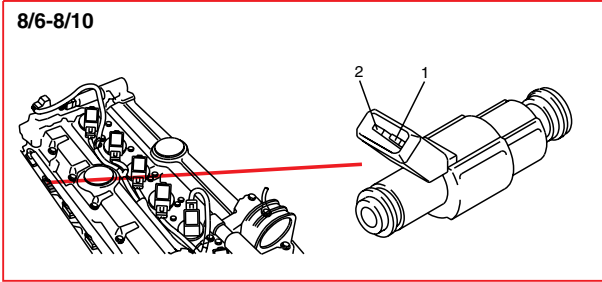
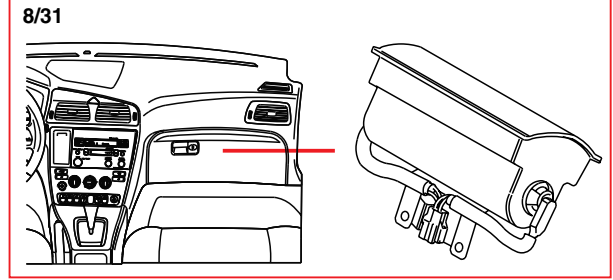
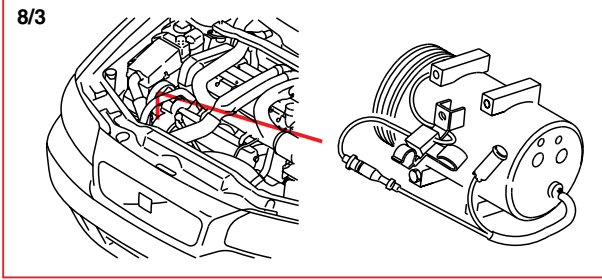

Pictures of components

8/44 - 9/2

8/44

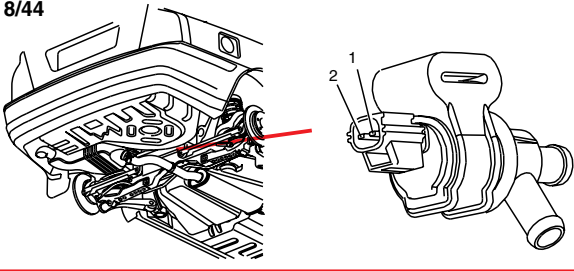

8/62

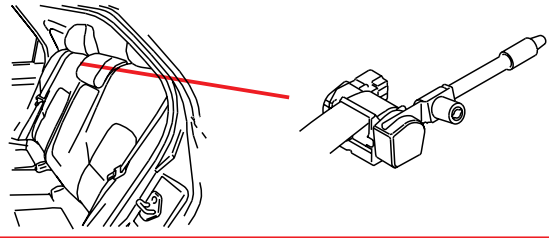

8/46

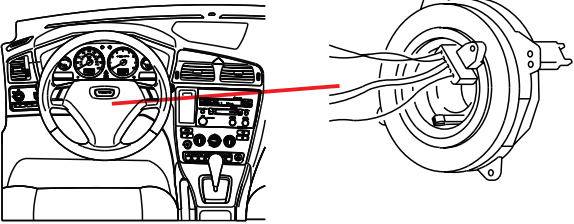

8/66-67

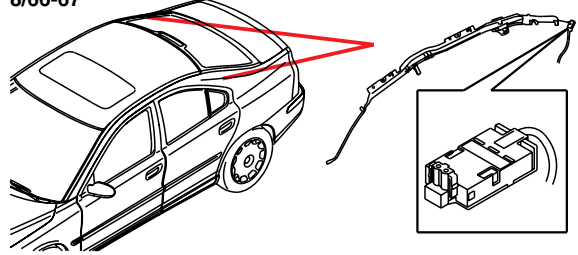

8/51-52

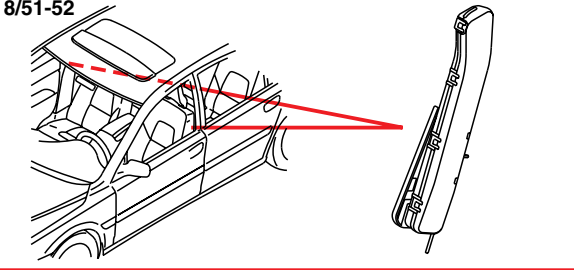

8/71-74

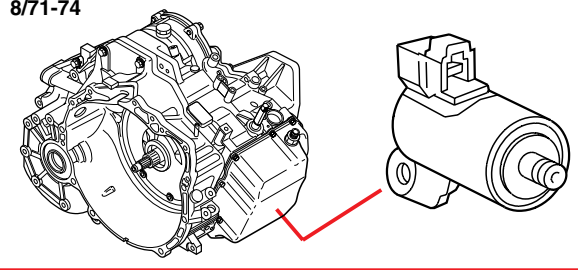

8/55-56

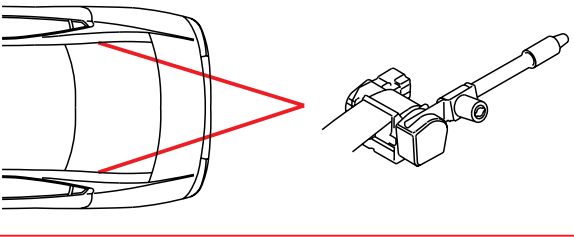

8/59-60

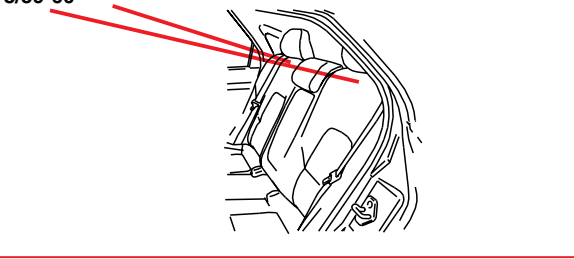

9/1

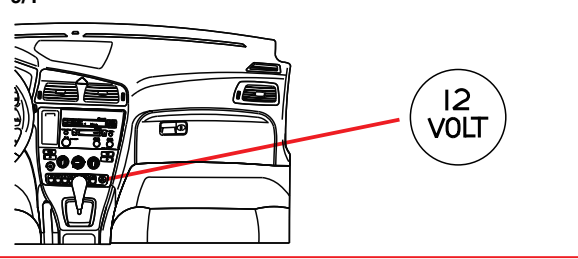

8/61

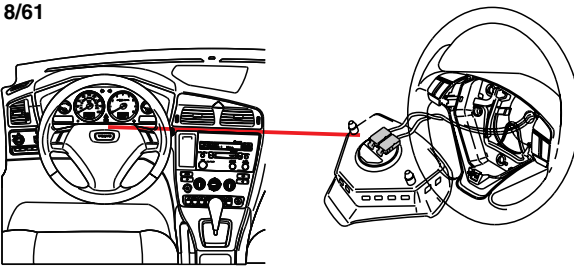

9/2

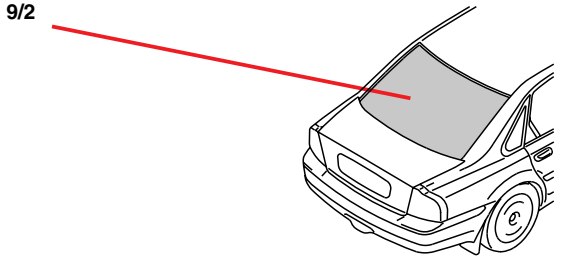

Pictures of components
9/12 - 10/14

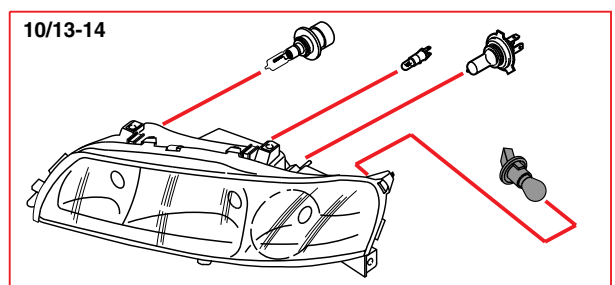
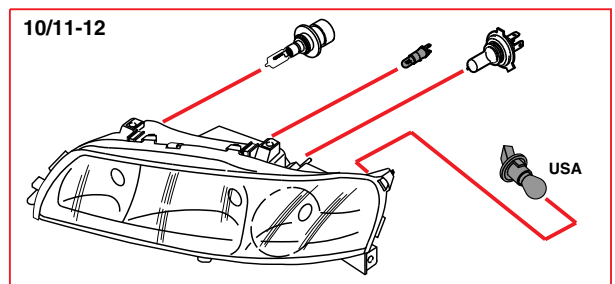
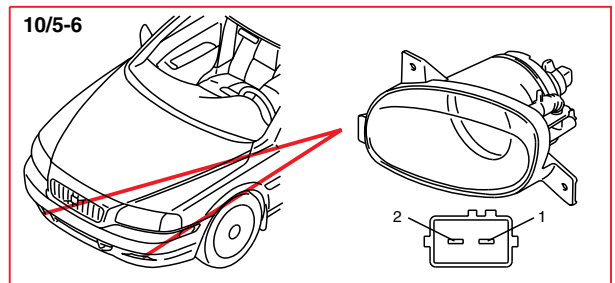
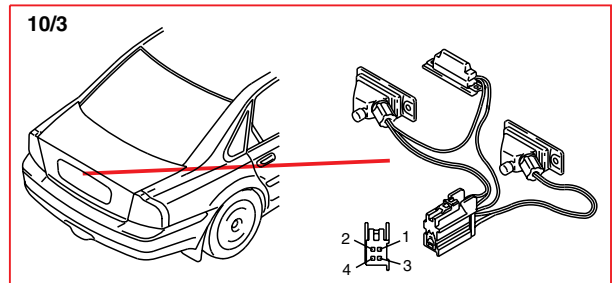
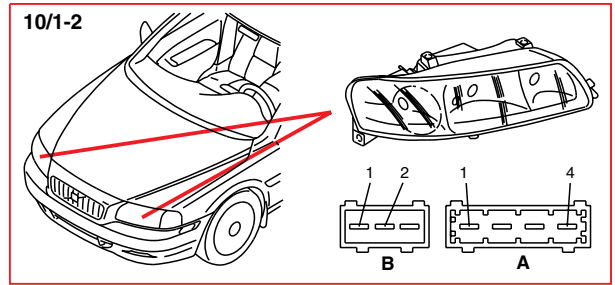
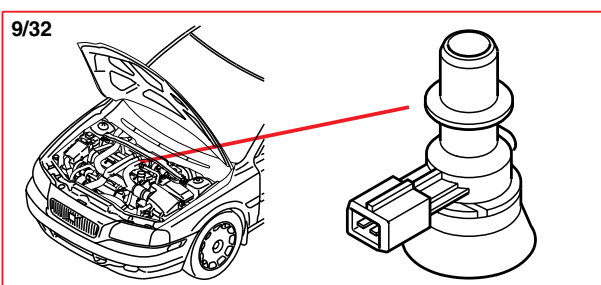
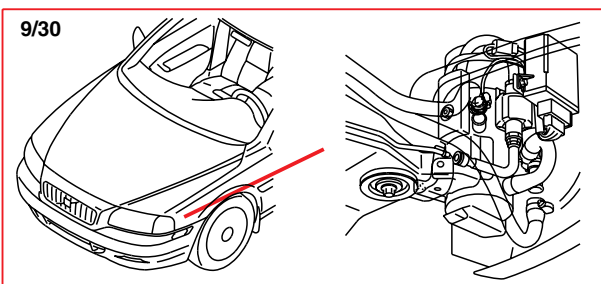
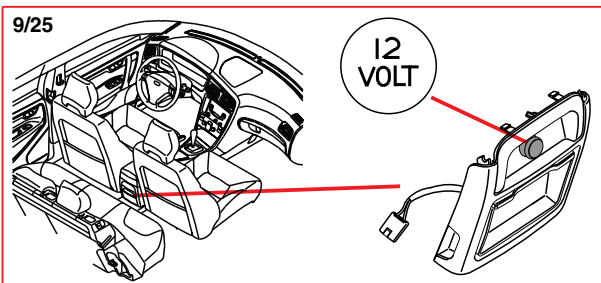
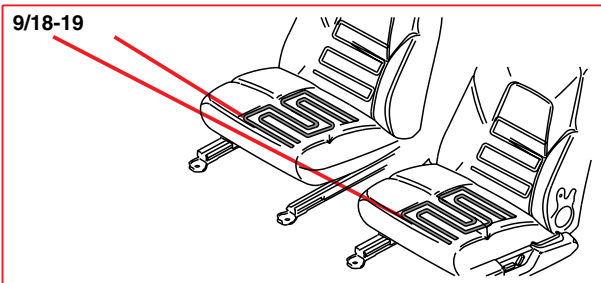
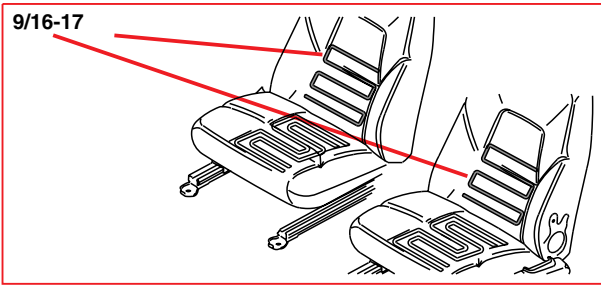
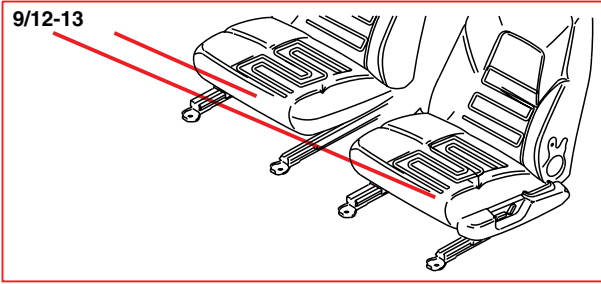

Pictures of components

10/15 - 10/50

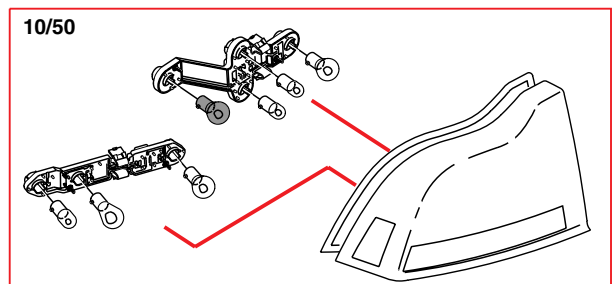
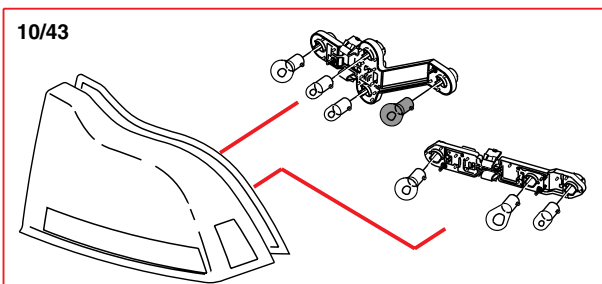
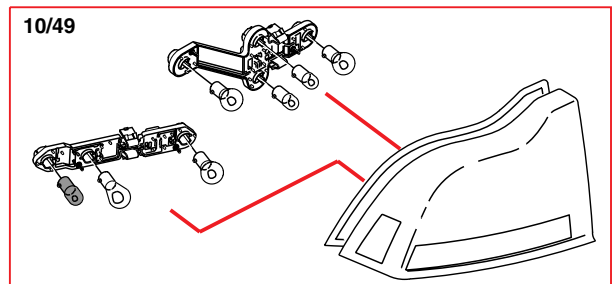
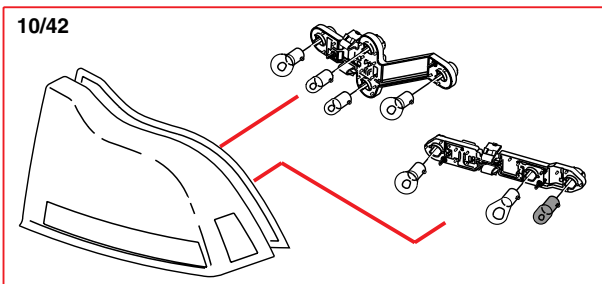
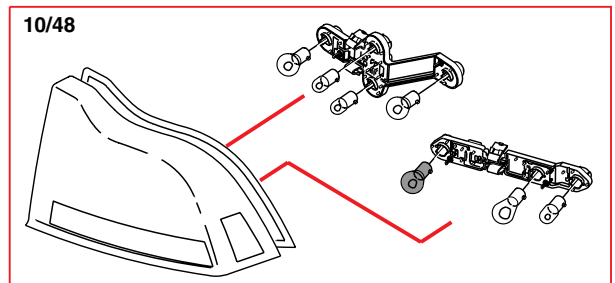
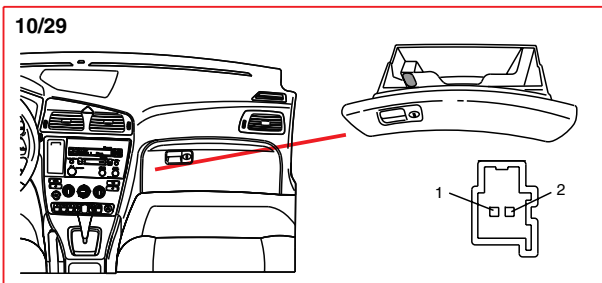
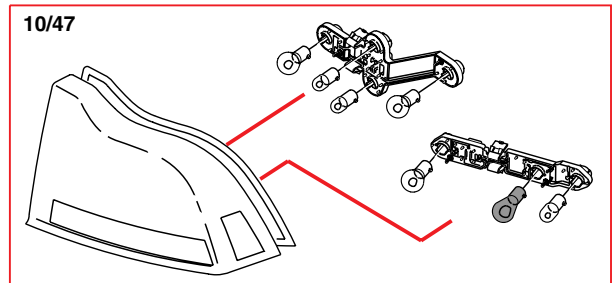
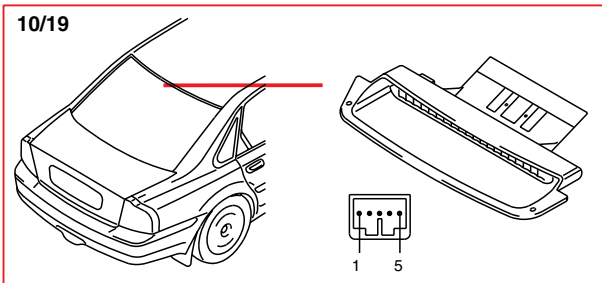
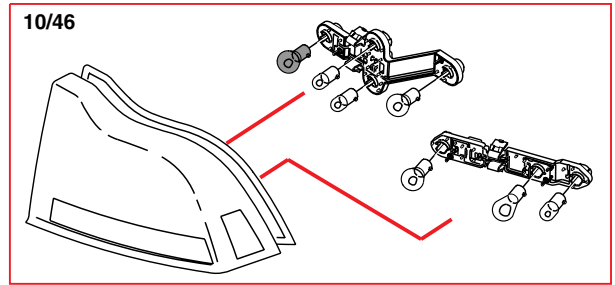
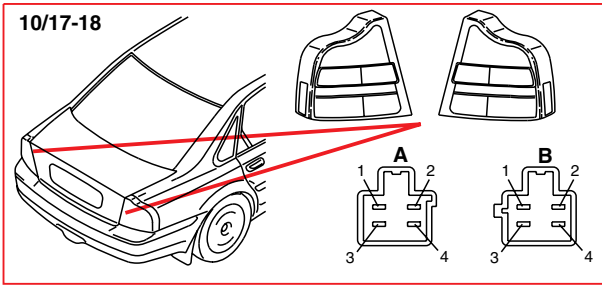
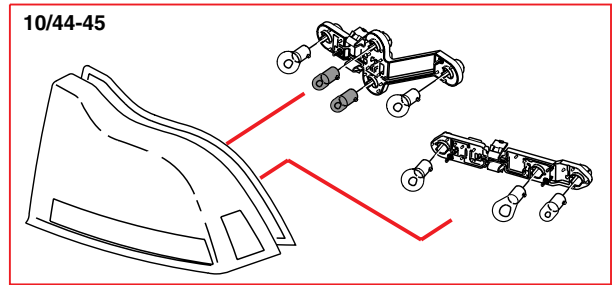
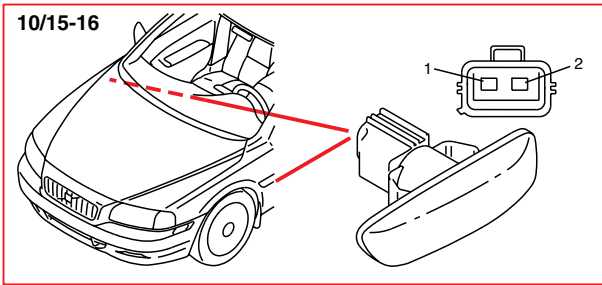

Pictures of components 10/51 - 10/125

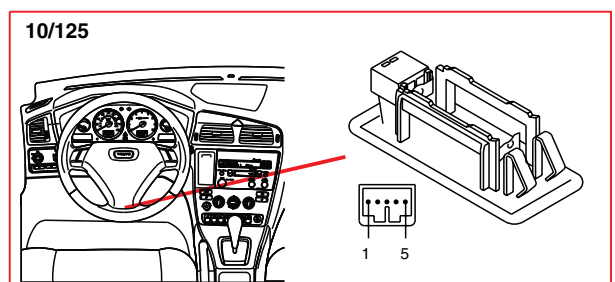
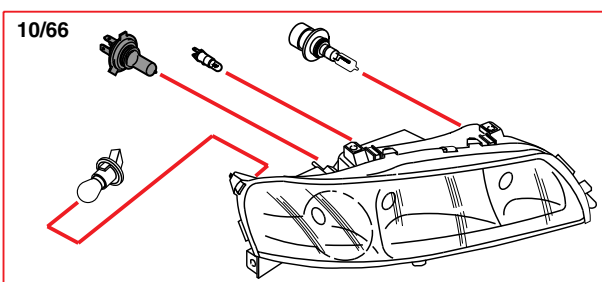
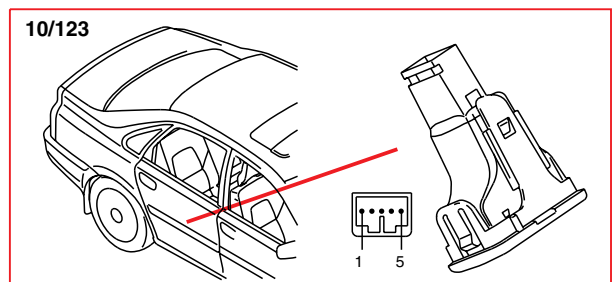
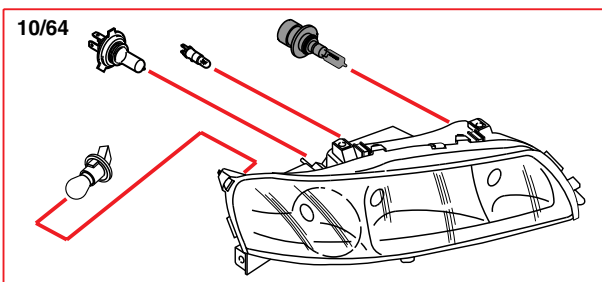
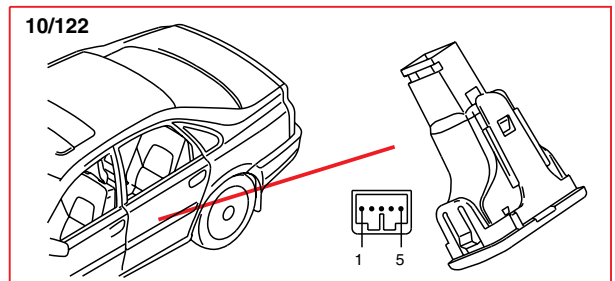
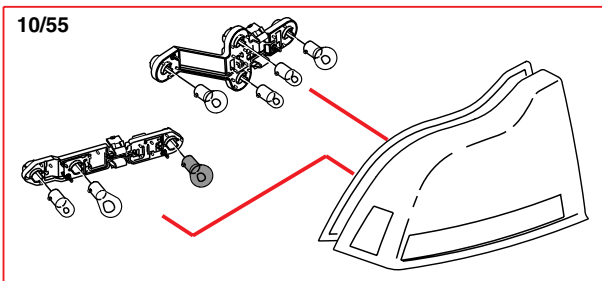
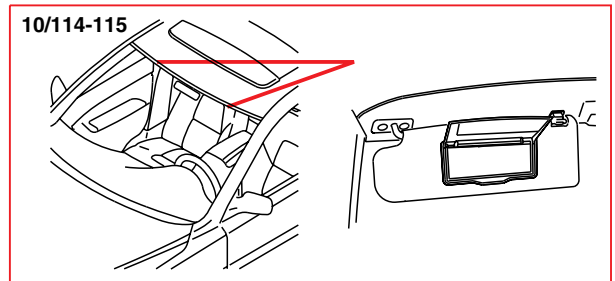
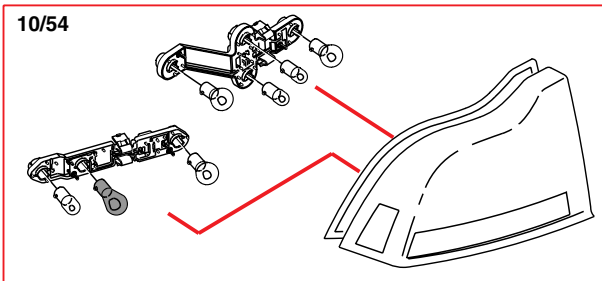
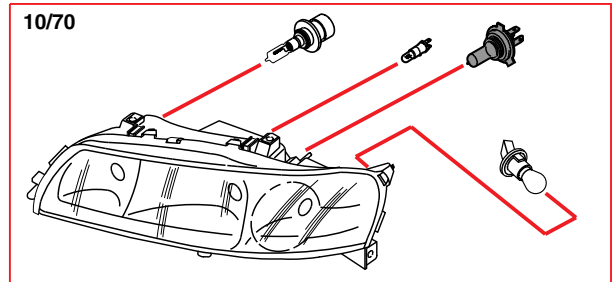
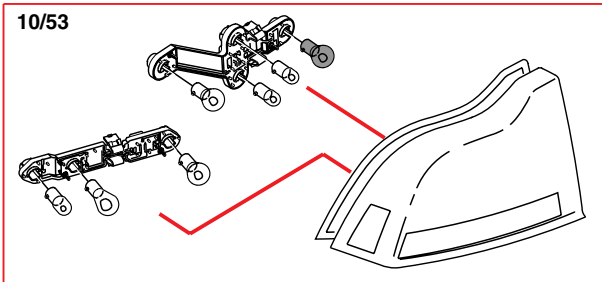
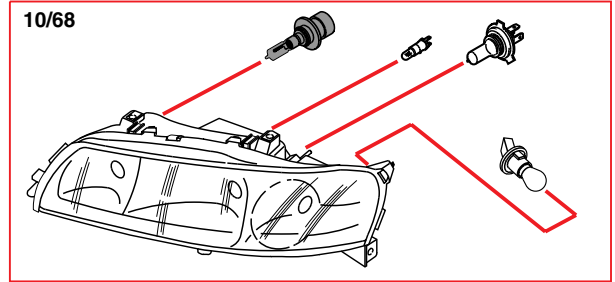
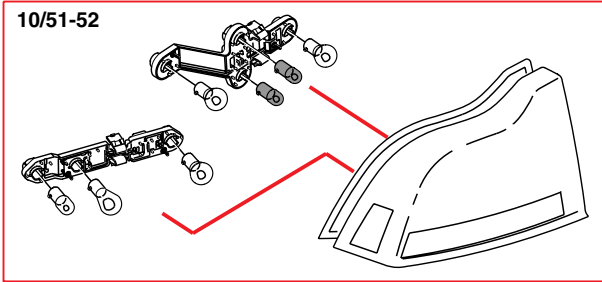

Pictures of components

10/126 - 11E

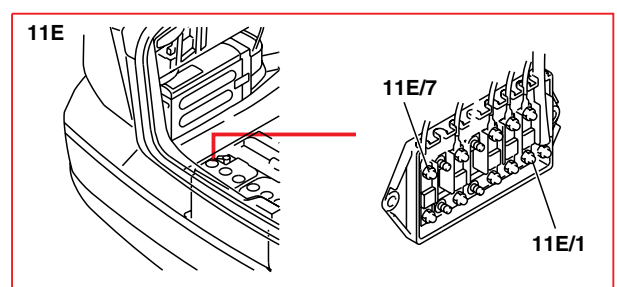
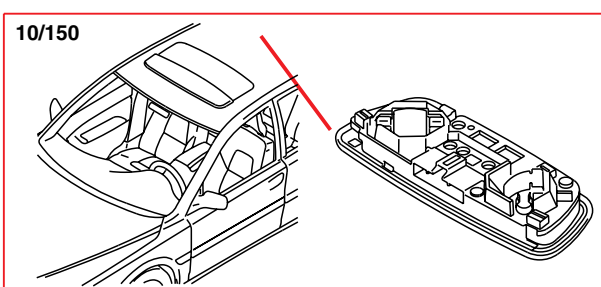
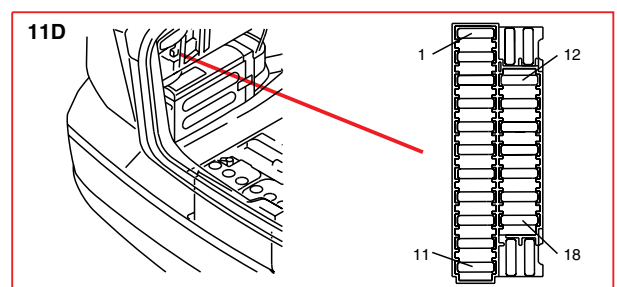
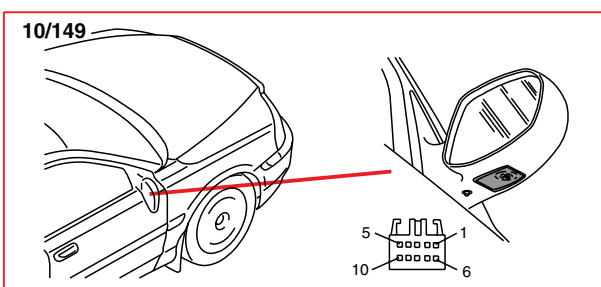
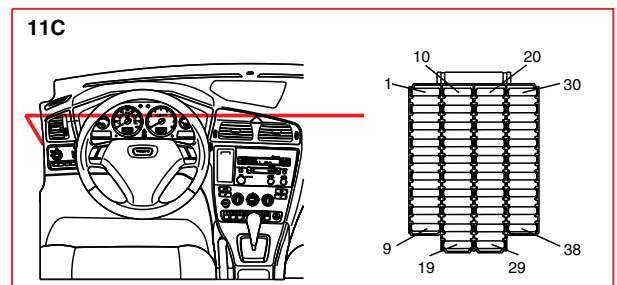
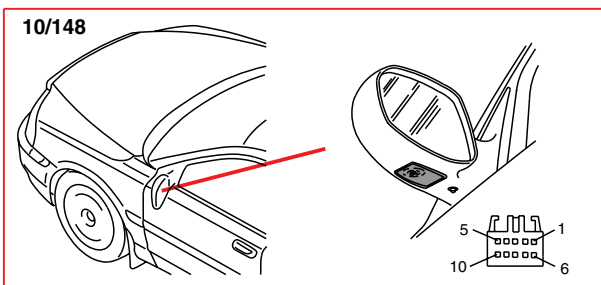
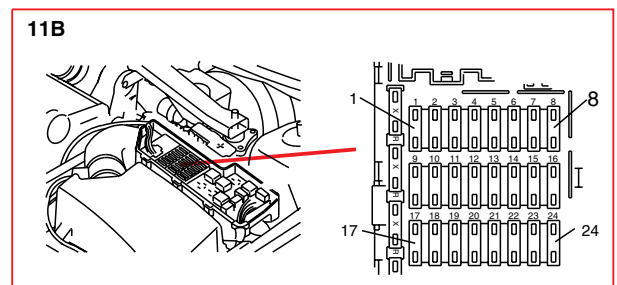
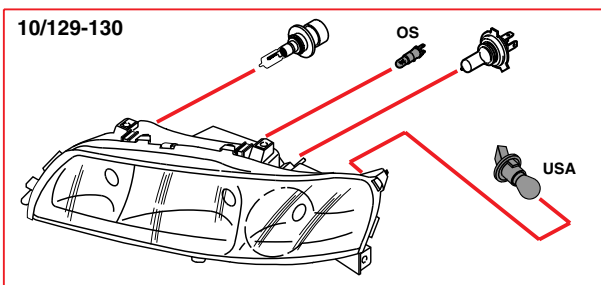
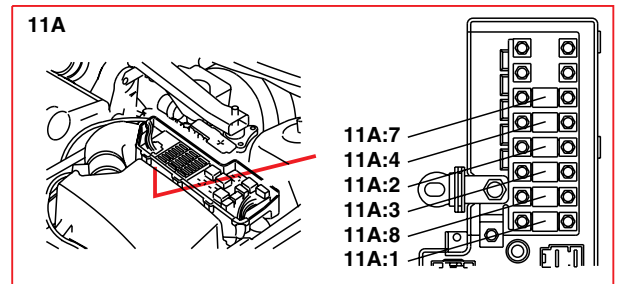
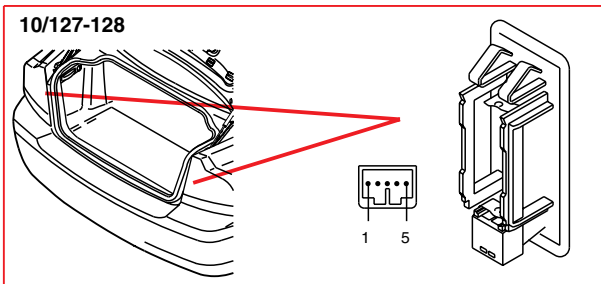
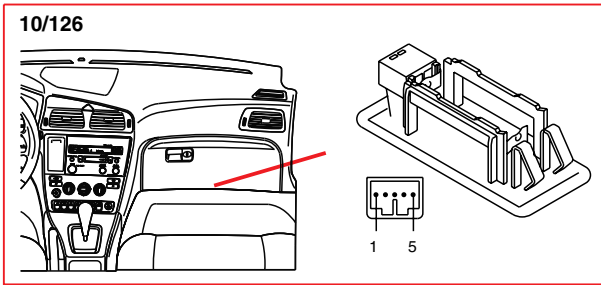

Pictures of components

15/20 - 16/2

15/25

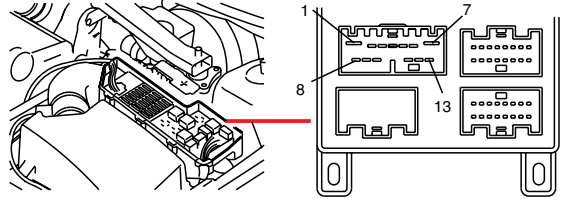

15/20

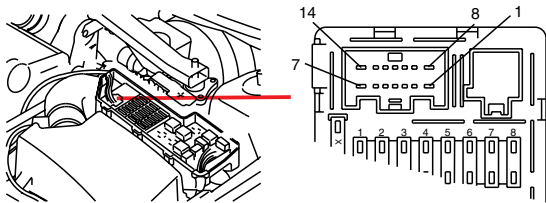

15/28

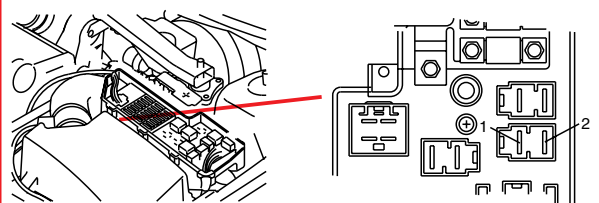

15/21

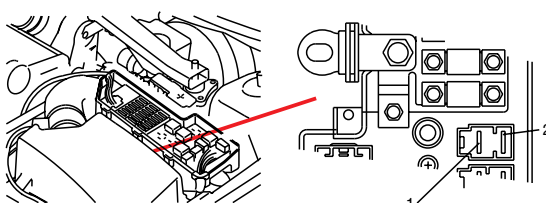

15/30

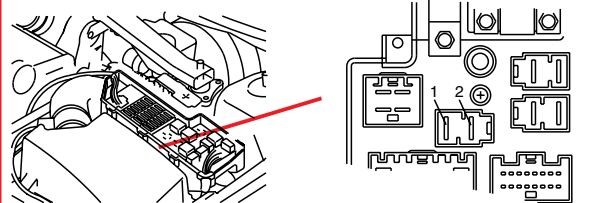

15/22

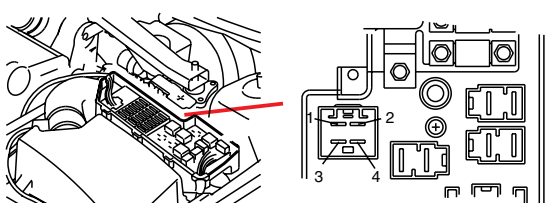

15/23

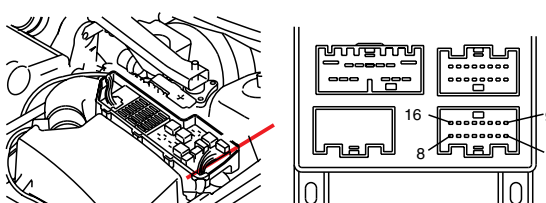

16/1

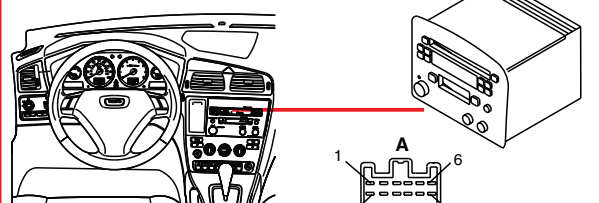

15/24

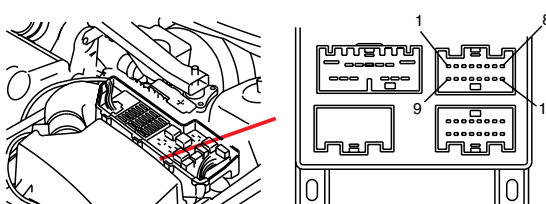

16/2

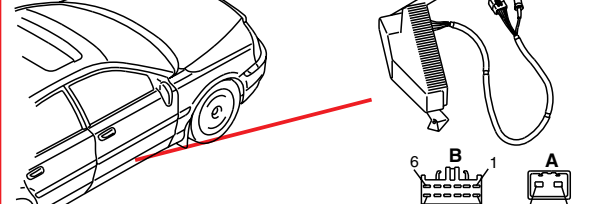

Pictures of components
16/47 - 16/73

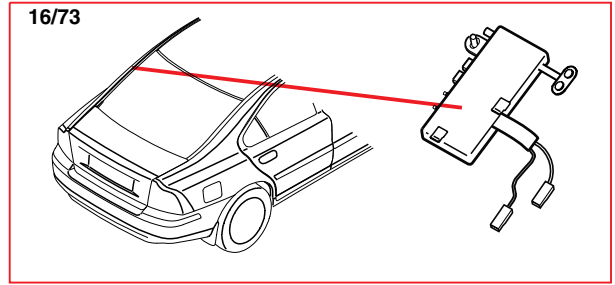
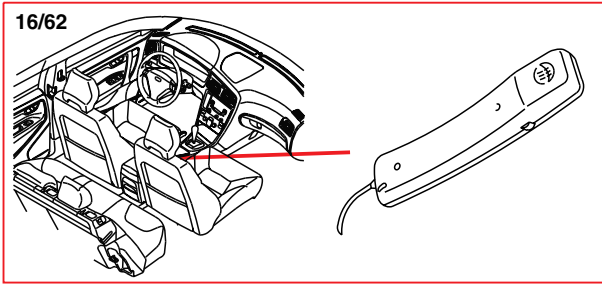
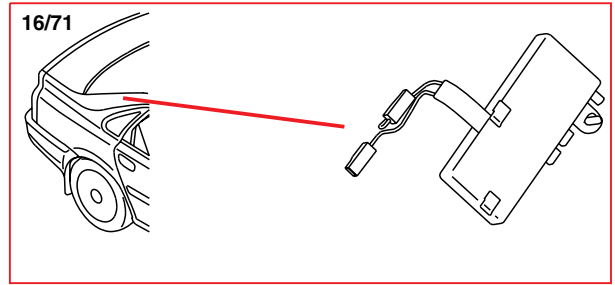
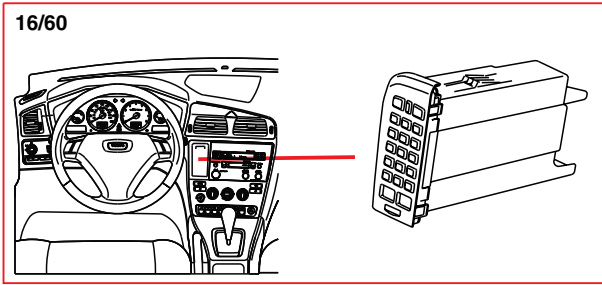
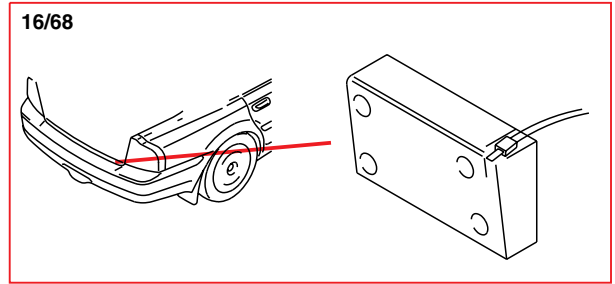
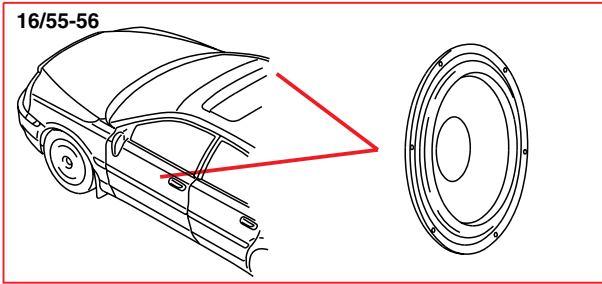
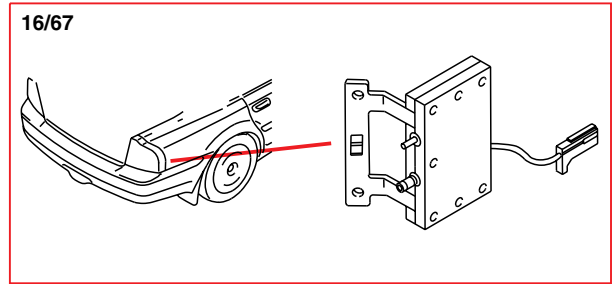
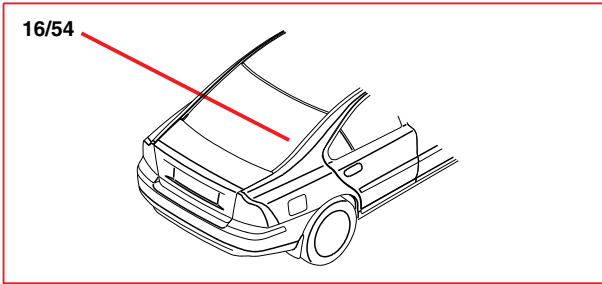
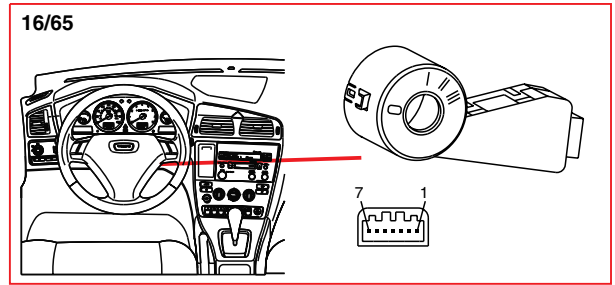
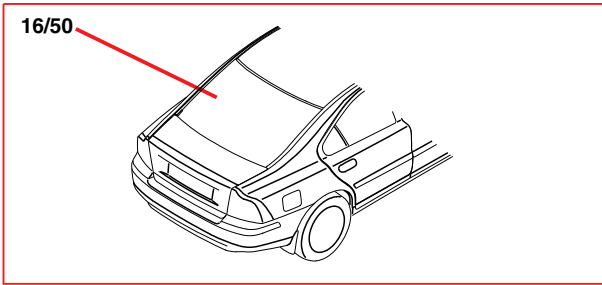
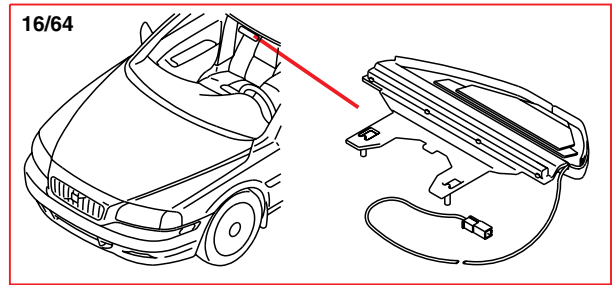
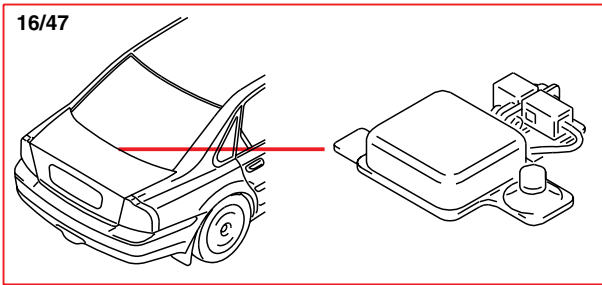

Pictures of components
16/74 - 20/27

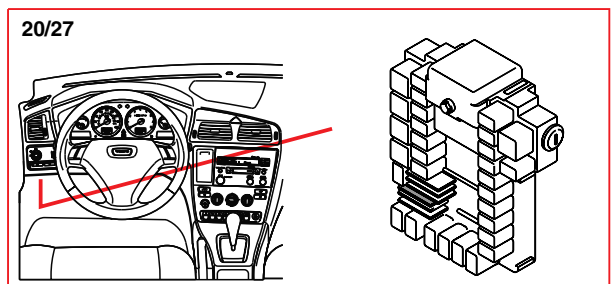
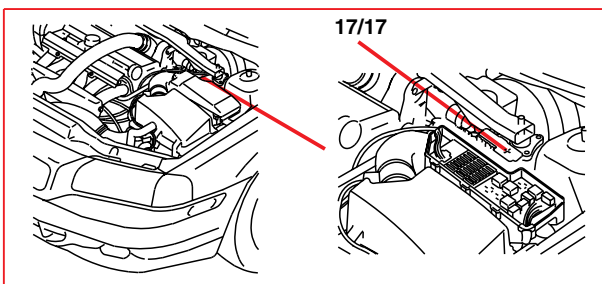
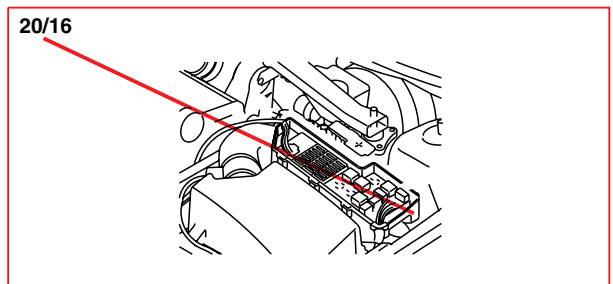
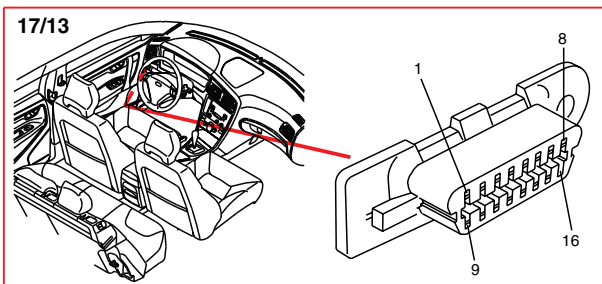
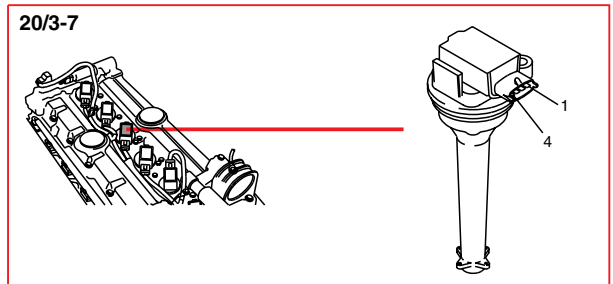
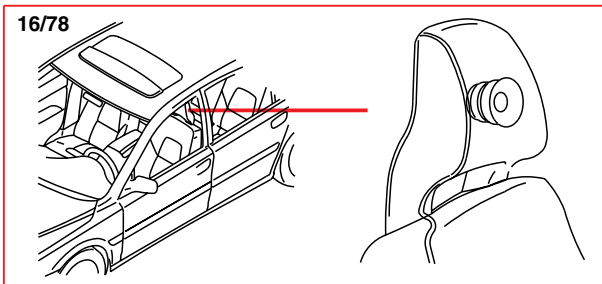
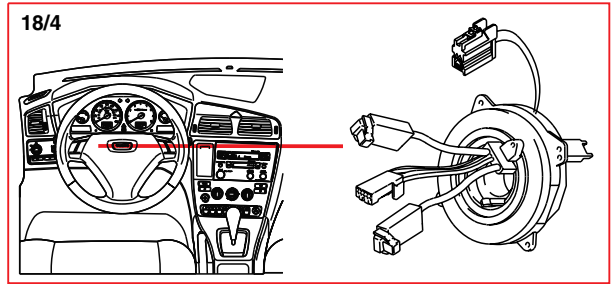
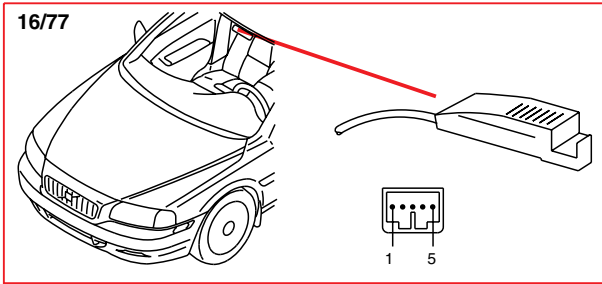
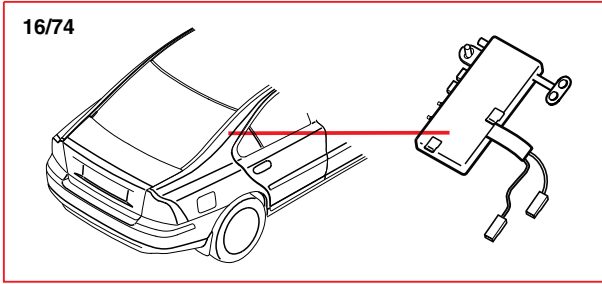

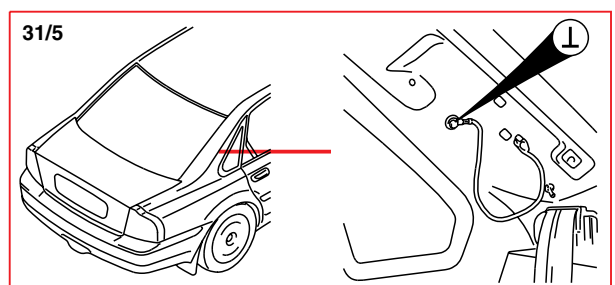
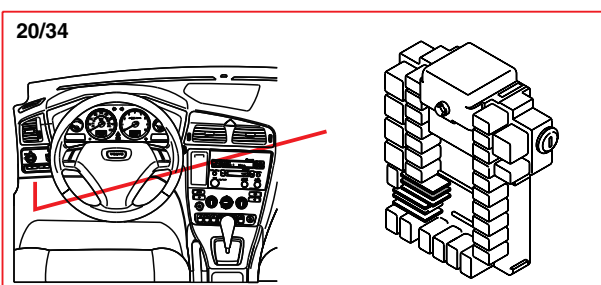
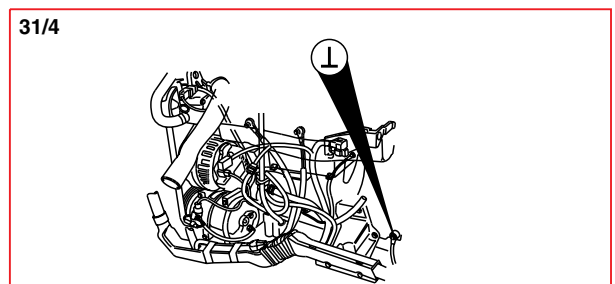
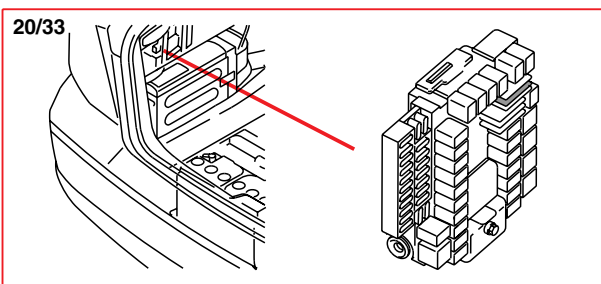
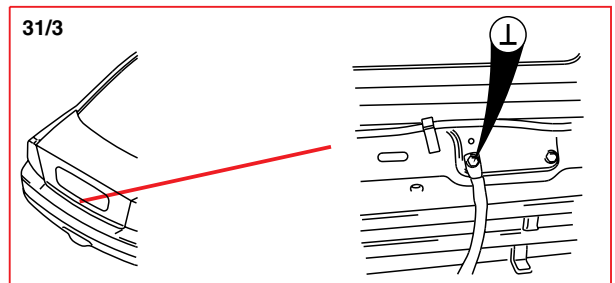
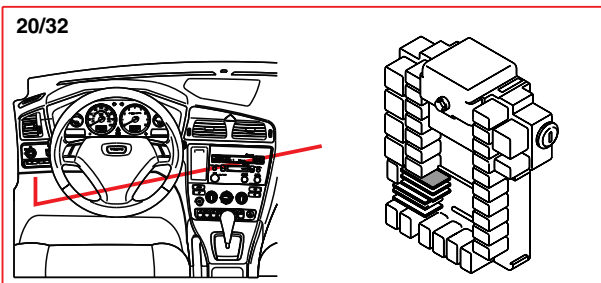
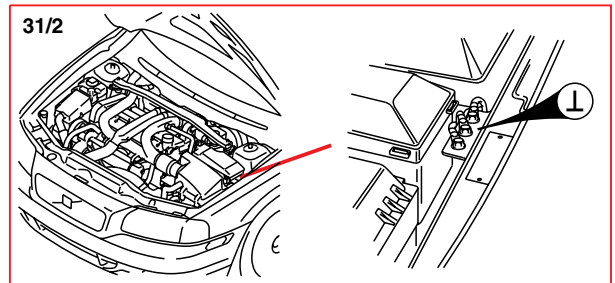
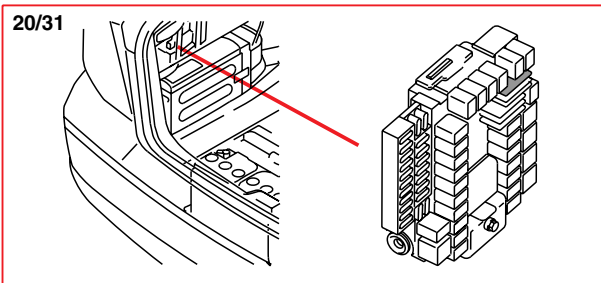
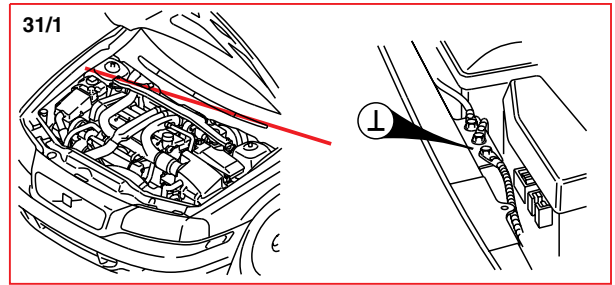
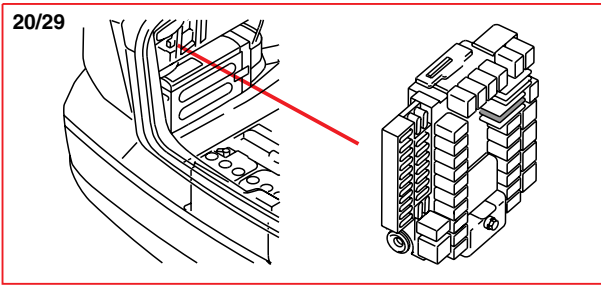
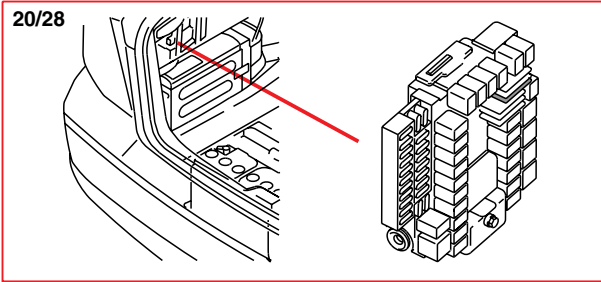

Pictures of components

31/6 - 31/84

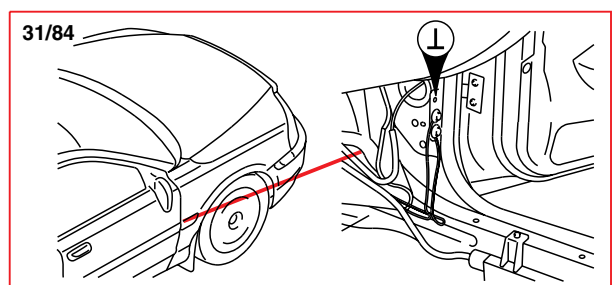
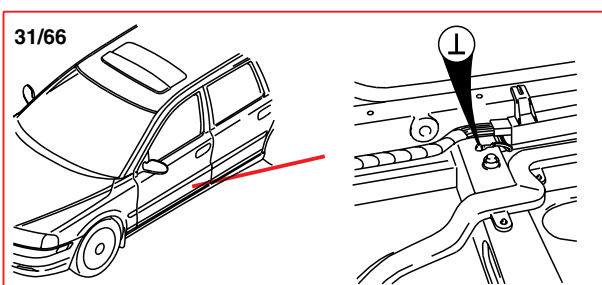
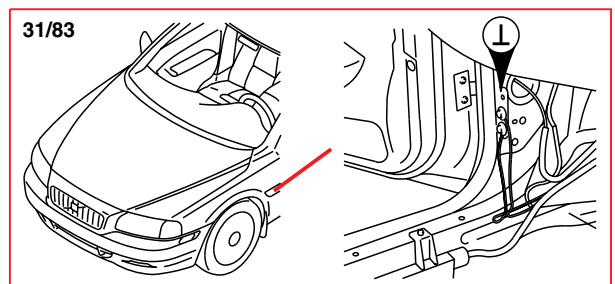
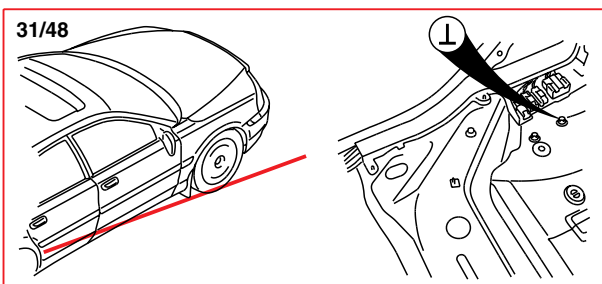
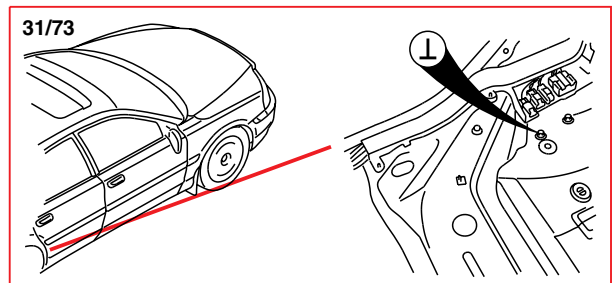
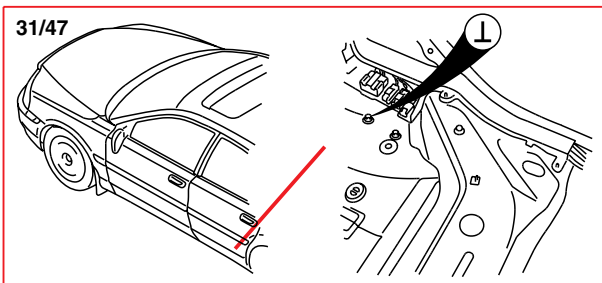
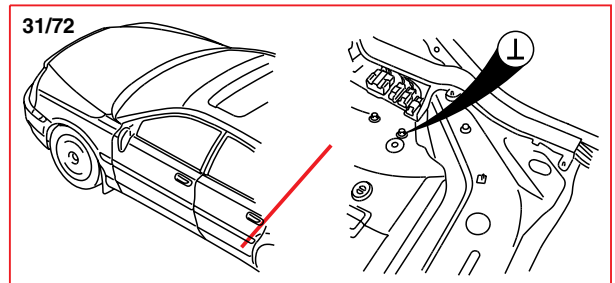
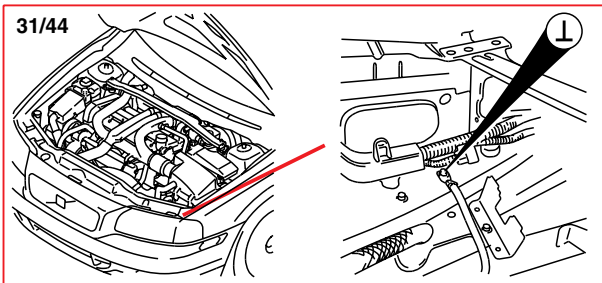
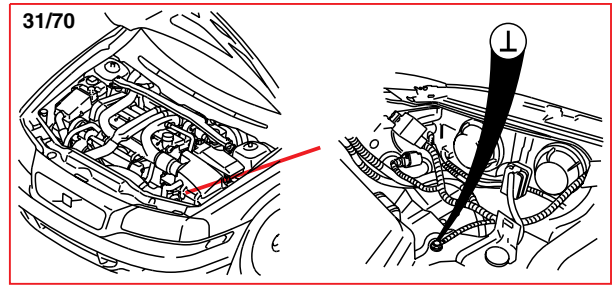
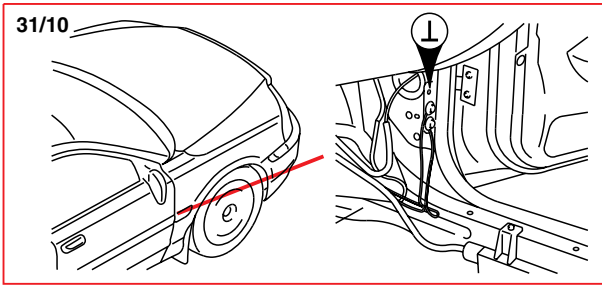
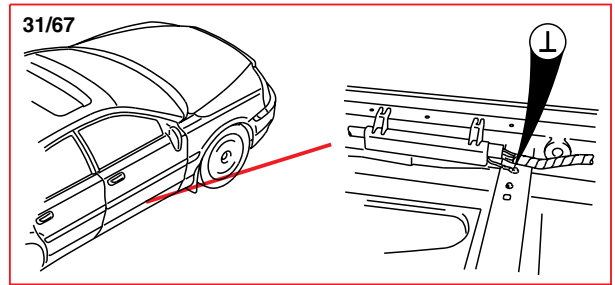
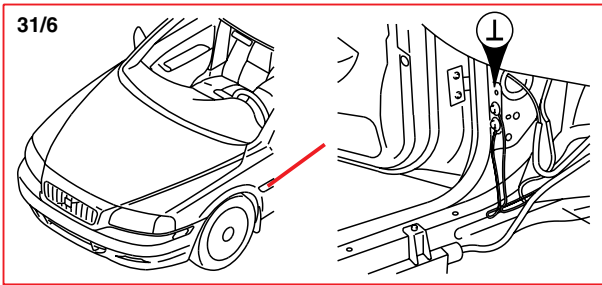

Pictures of components
31/88 - 54/3

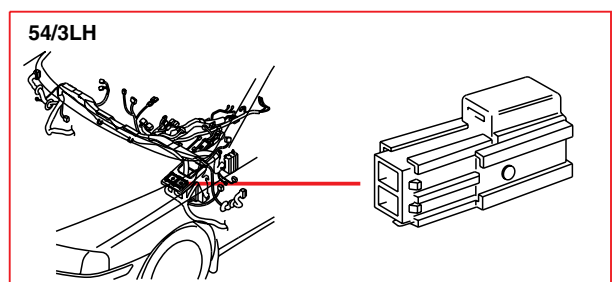
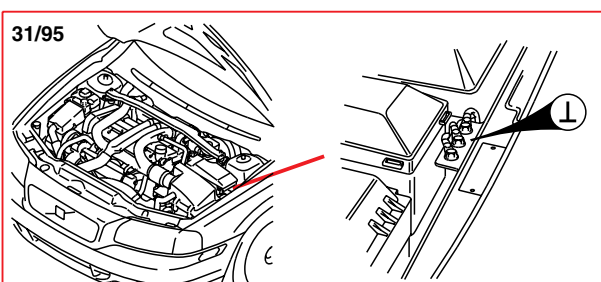
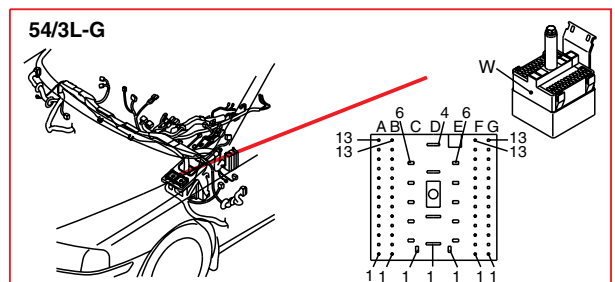
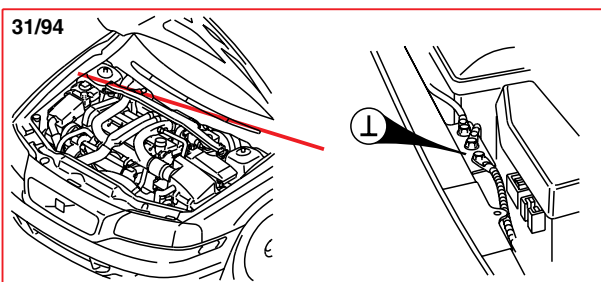
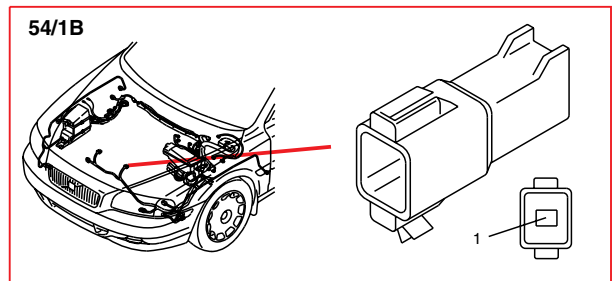
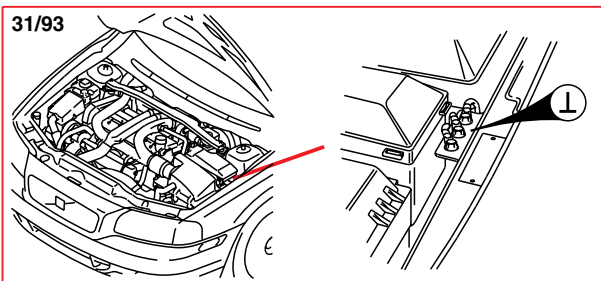
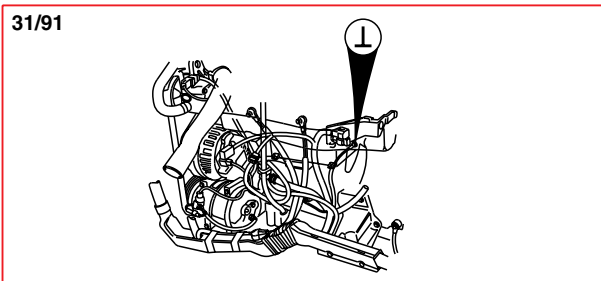
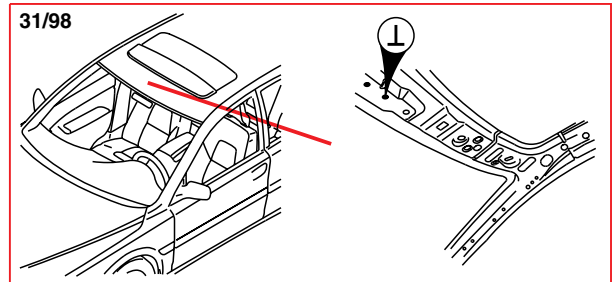
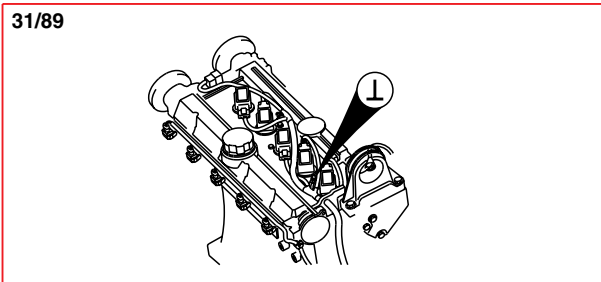
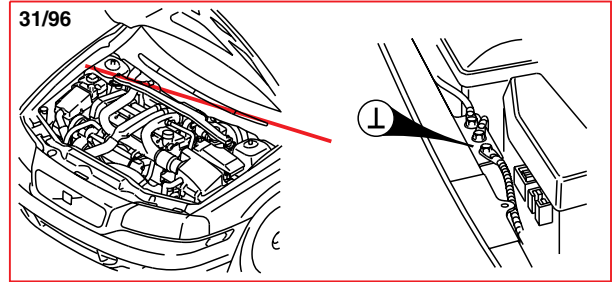
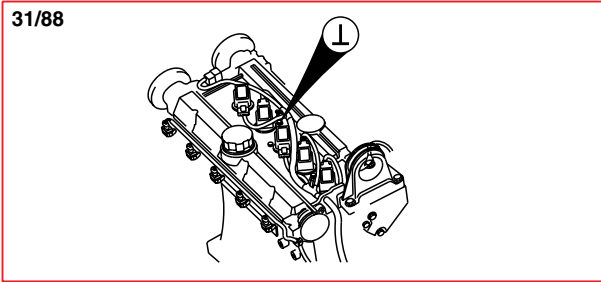

Pictures of components

54/8 - 54/24

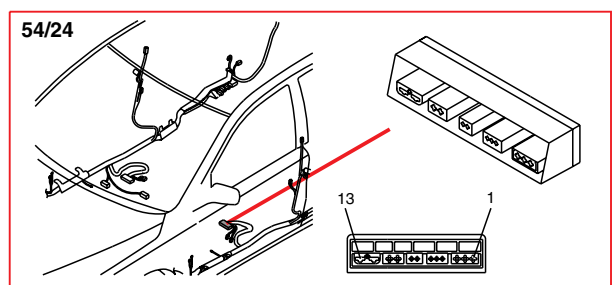
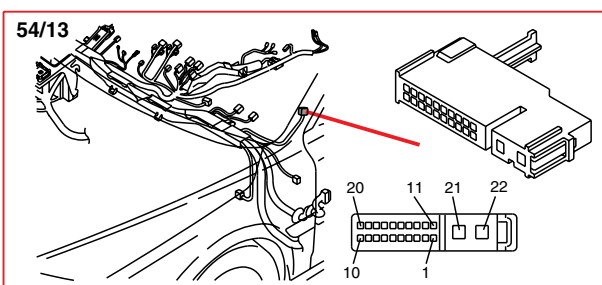
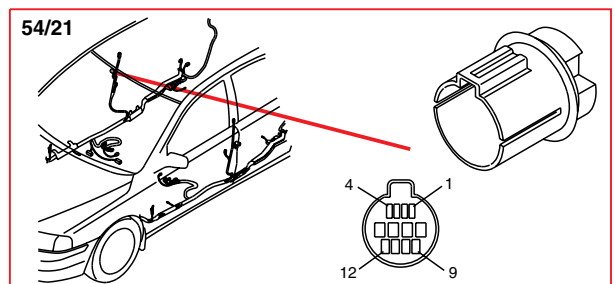
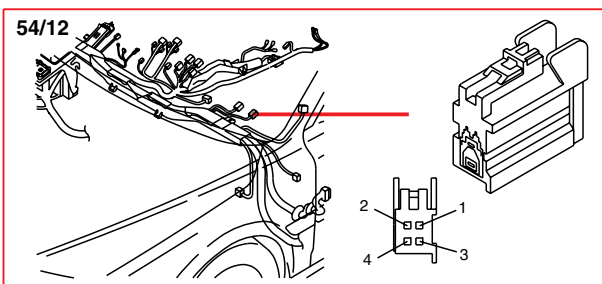
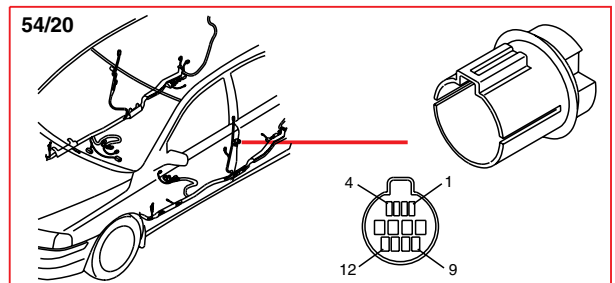
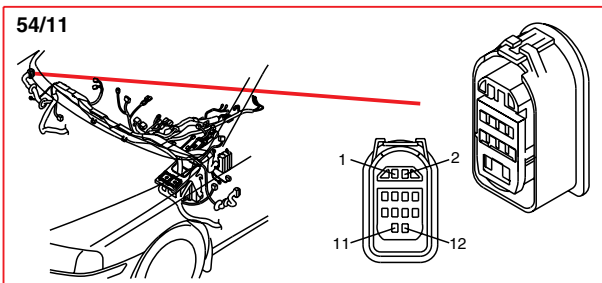
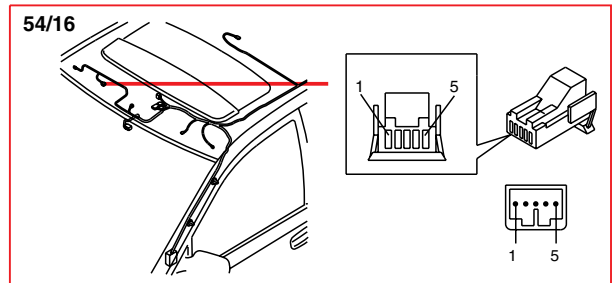
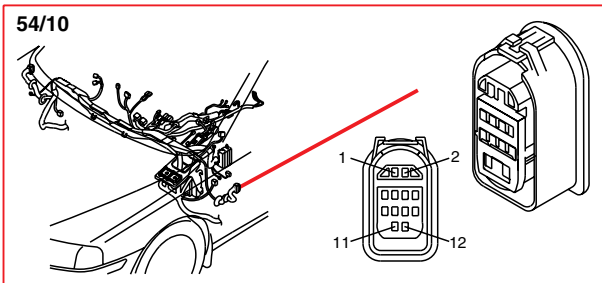
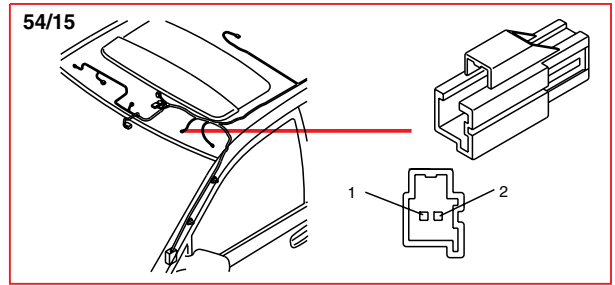
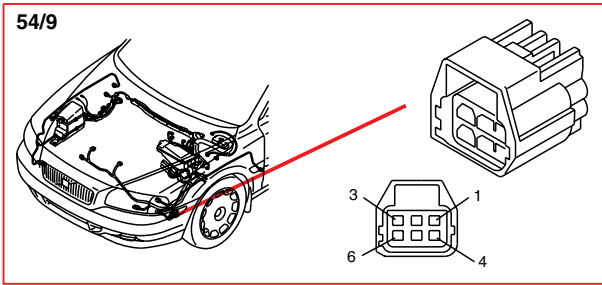
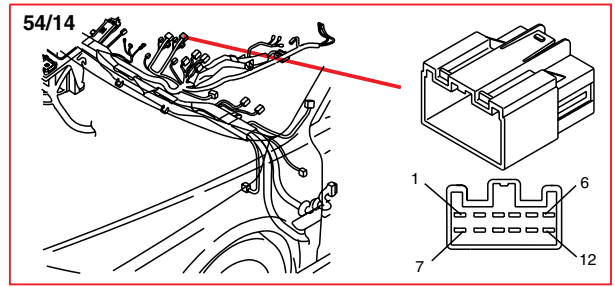
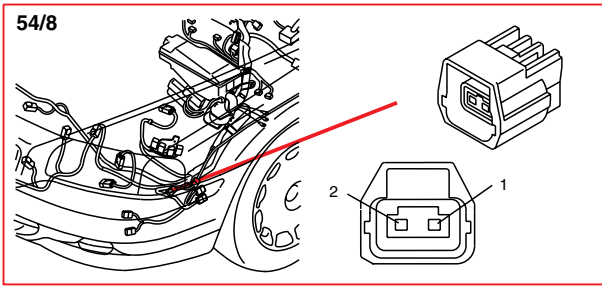

Pictures of components 54/25 - 54/56

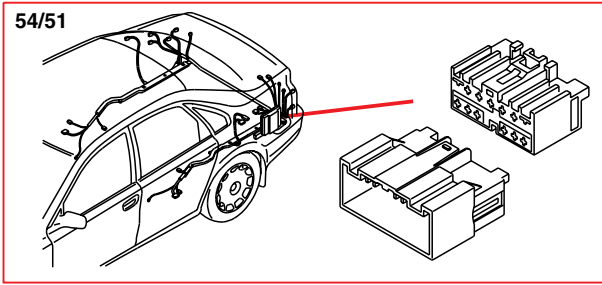
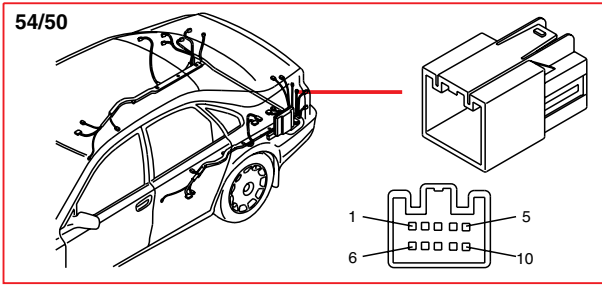
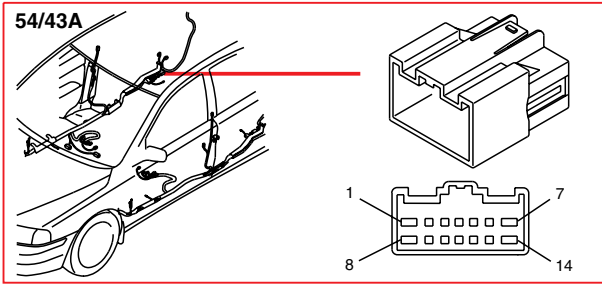
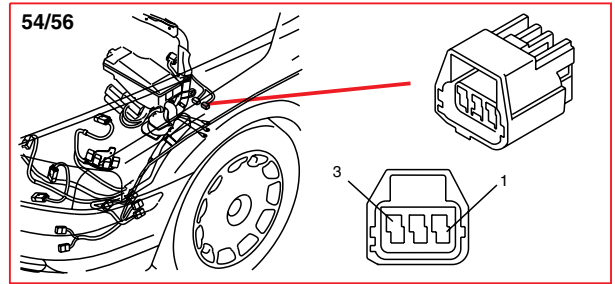
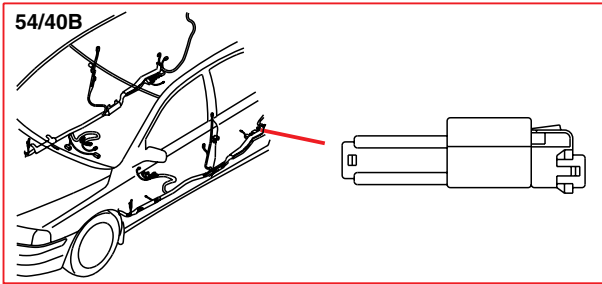
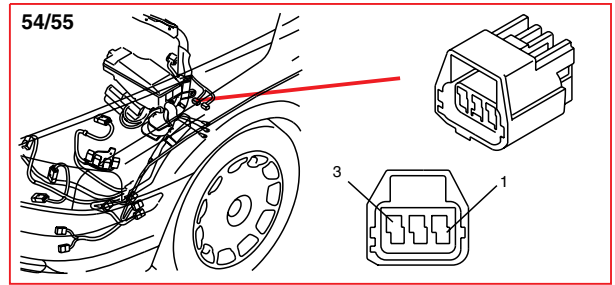
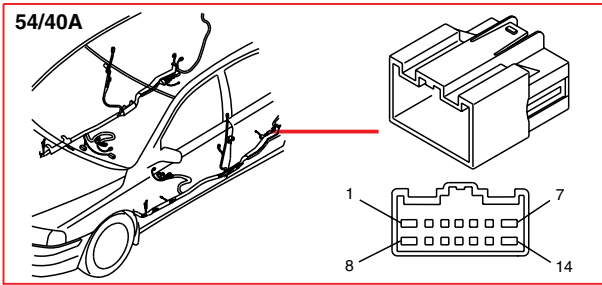
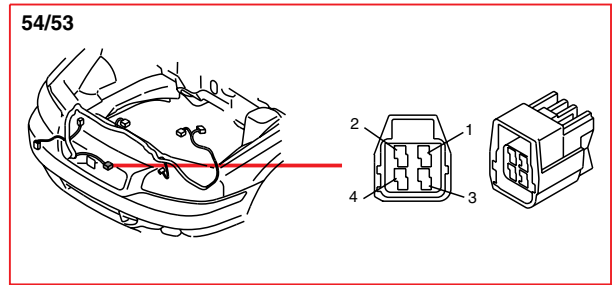
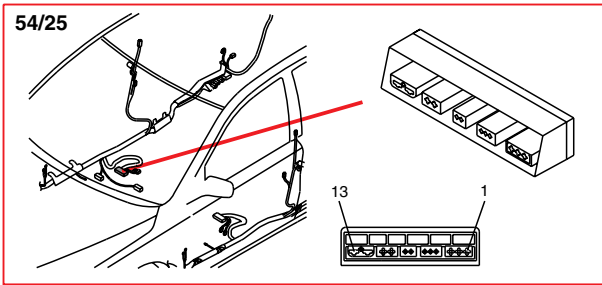

How to use the wiring diagram

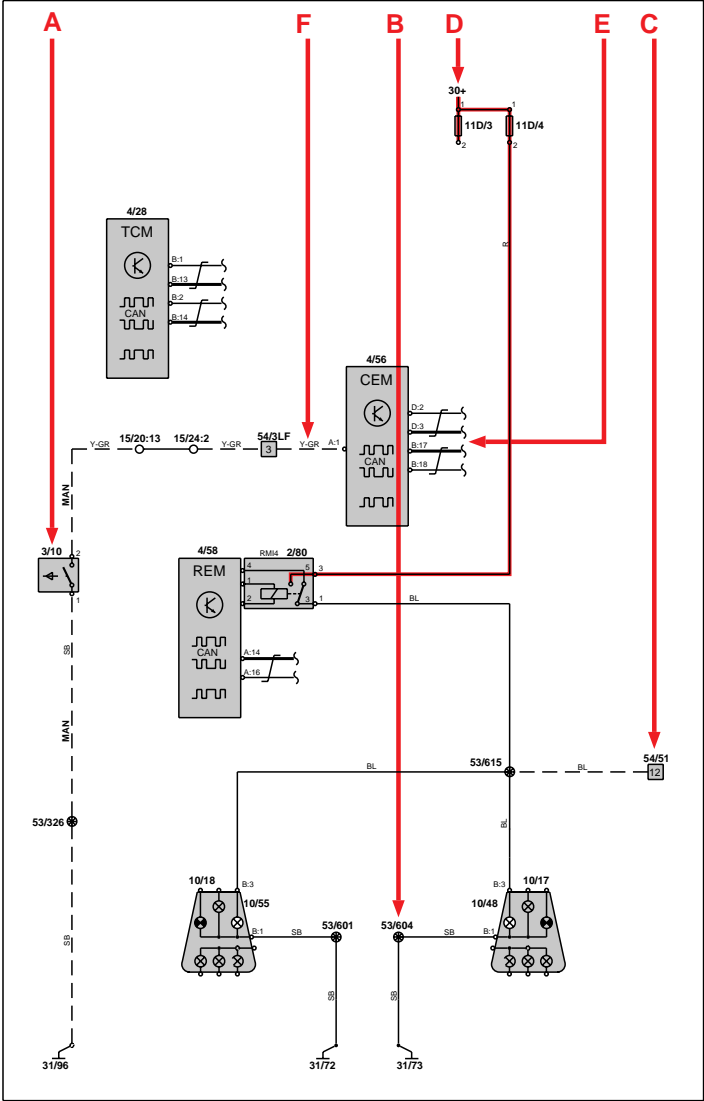

List of symbols

- = System voltage
- = Ground connection via wiring
- = Ground connection on component/chassis
- = Screened wire
- = Junction point
- = Twisted cable
- = Electrical connection
- = Variant
- = CAN communication
- = CAN high signal (CAN H)
- = CAN low signal (CAN L)
- = Serial communication
- = DIN cable, coaxial cable, etc.
- = Data communication
- = CAN communication
- = Connection with fuse box
- = Further connection to...
- = Connector between wiring harnesses
- = Connector connected to component

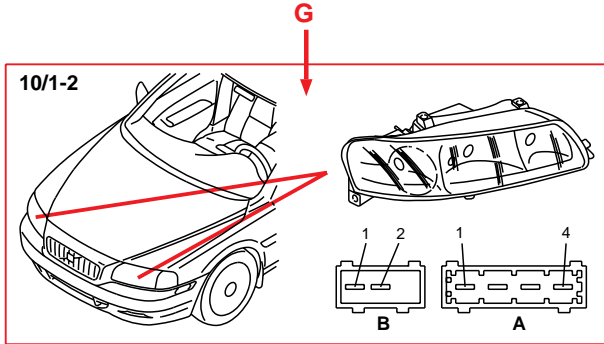

Pictures of components

16/3 - 16/46

